

## MCZ TO 24VDC/50MS

**Weidmüller Interface GmbH & Co. KG**

Klingenbergstraße 26

D-32758 Detmold

Germany

[www.weidmueller.com](http://www.weidmueller.com)

### Product image



The narrow pulse stretcher measuring just 6.1 mm wide Pulse stretchers are used in automation technology to extend very short input pulses of less than 10 ms. Such short pulses are generated by light barriers, for example, and cannot be processed by conventional timing relays. The extended pulses, on the other hand, can be forwarded directly to the PLC. MCZ TO is one of the narrowest pulse stretchers on the market. It extends even very short pulses  $\geq 3.5$  ms and has a fixed switch-off delay (50 ms or 150 ms). MCZ TO operates with low input power, and auxiliary voltages in the input and output are not required. It also includes a watchdog function with restarting of the off-delay. Precisely fitting accessories such as cross-connectors, markers and end plates make it flexible to use.

- Detection of very short input pulses ( $\geq 3.5$  ms)
- Versatile to use thanks to three cross-connector connections
- Proven and reliable tension clamp connection system
- High level of safety thanks to integrated reverse polarity protection

### General ordering data

Version	MCZ SERIES, Pulse stretcher, Number of contacts: 1, NO contact, Rated control voltage: 24 V DC $\pm 10$ %, Continuous current: 20 mA, Tension-clamp connection
Order No.	<a href="#">8324590000</a>
Type	MCZ TO 24VDC/50MS
GTIN (EAN)	4008190985455
Qty.	10 pc(s).

## MCZ TO 24VDC/50MS

**Weidmüller Interface GmbH & Co. KG**

Klingenbergstraße 26

D-32758 Detmold

Germany

www.weidmueller.com

## Technical data

### Dimensions and weights

Depth	63.2 mm	Depth (inches)	2.488 inch
Height	91 mm	Height (inches)	3.583 inch
Width	6.1 mm	Width (inches)	0.24 inch
Net weight	22.4 g		

### Temperatures

Storage temperature	-40 °C...85 °C	Operating temperature	-25 °C...50 °C
Operating temperature, min.	-25 °C	Operating temperature, max.	50 °C
Humidity	40 °C / 93 % rel. humidity, no condensation		

### Rated data UL

Certificate No. (cURus)	E141197
-------------------------	---------

### Control side

Rated control voltage	24 V DC $\pm$ 10 %	Rated current DC	6.7 mA $\pm$ 10 %
Power rating	160 mW	Status indicator	Green LED
Protective circuit	Reverse polarity protection	Min. pulse duration	2 ms

### Load side

Rated switching voltage	5...48 V DC	Continuous current	20 mA
Max. switching frequency at rated load	5 Hz	Max. switching voltage, DC	48 V
Inrush current	200 mA	Switch-off delay	50 ms
Contact type	1 NO contact (Transistor)		

### General data

Suitable for front mounting	No	
Rail	TS 35	
Test button available	No	
Mechanical switch position indicator	No	
Open sides	right	
Colour	beige	
UL94 flammability rating component	Component	Housing
	UL94 flammability rating	V-0

### Insulation coordination

Rated voltage	300 V	Pollution severity	2
Surge voltage category	IV	Clearance and creepage distances for control side - load side	$\geq$ 5.5 mm
Dielectric strength for control side - load side	1 kV <sub>eff</sub> / 1 s	Dielectric strength to mounting rail	4 kV <sub>eff</sub> / 1 Min.
Impulse withstand voltage	6 kV (1.2/50 $\mu$ s)		

### Further details of approvals / standards

Certificate No. (CSA)	154685-1198742	Certificate No. (cURus)	E141197
-----------------------	----------------	-------------------------	---------

## MCZ TO 24VDC/50MS

Weidmüller Interface GmbH &amp; Co. KG

Klingenbergstraße 26

D-32758 Detmold

Germany

www.weidmueller.com

## Technical data

## Connection data

Wire connection method	Tension-clamp connection	Stripping length, rated connection	8 mm
Clamping range, rated connection	1.5 mm <sup>2</sup>	Clamping range, min.	0.5 mm <sup>2</sup>
Clamping range, max.	1.5 mm <sup>2</sup>	Wire connection cross section AWG, min.	AWG 26
Wire connection cross section AWG, max.	AWG 16	Wire cross-section, solid, min.	0.5 mm <sup>2</sup>
Wire cross-section, solid, max.	1.5 mm <sup>2</sup>	Wire cross-section, solid, min. (AWG)	AWG 26
Wire cross-section, solid, max. (AWG)	AWG 16	Wire connection cross section, finely stranded, min.	0.5 mm <sup>2</sup>
Wire connection cross section, finely stranded, max.	1.5 mm <sup>2</sup>	Wire cross-section, finely stranded, min. (AWG)	AWG 26
Wire cross-section, finely stranded, max. (AWG)	AWG 16	Wire connection cross-section, finely stranded with wire-end ferrules DIN 46228/4, min.	0.5 mm <sup>2</sup>
Wire connection cross-section, finely stranded with wire-end ferrules DIN 46228/4, max.	1.5 mm <sup>2</sup>	Conductor cross-section, flexible, AEH (DIN 46228-1), min.	0.5 mm <sup>2</sup>
Conductor cross-section, flexible, AEH (DIN 46228-1), max.	1.5 mm <sup>2</sup>	Blade size	0.6 x 3.5 mm

## Classifications

ETIM 6.0	EC001439	ETIM 7.0	EC001439
ETIM 8.0	EC001439	ECLASS 9.0	27-37-16-05
ECLASS 9.1	27-37-16-05	ECLASS 10.0	27-37-16-05
ECLASS 11.0	27-37-16-05	ECLASS 12.0	27-37-16-05

## Environmental Product Compliance

REACH SVHC	Lead 7439-92-1
SCIP	35d83707-6a3b-45b5-b9f8-6ba8184c863e

## Important note

Product information	The cable lengths must not exceed 30 m.
---------------------	---

## Approvals

Approvals



ROHS	Conform
UL File Number Search	UL Website
Certificate No. (cURus)	E141197

## Downloads

Approval/Certificate/Document of Conformity	<a href="#">EU Konformitätserklärung / EU Declaration of Conformity</a>
Engineering Data	<a href="#">CAD data – STEP</a>
Engineering Data	<a href="#">WSCAD, EPLAN</a>
User Documentation	<a href="#">Beipackzettel / Package Insert – multilingual</a>
Catalogues	<a href="#">Catalogues in PDF-format</a>
Brochures	

Creation date July 4, 2023 6:57:23 AM CEST

Catalogue status 24.06.2023 / We reserve the right to make technical changes.

3

**MCZ TO 24VDC/50MS**

**Weidmüller Interface GmbH & Co. KG**  
 Klingenbergstraße 26  
 D-32758 Detmold  
 Germany

www.weidmueller.com

**Drawings**

**Product image**

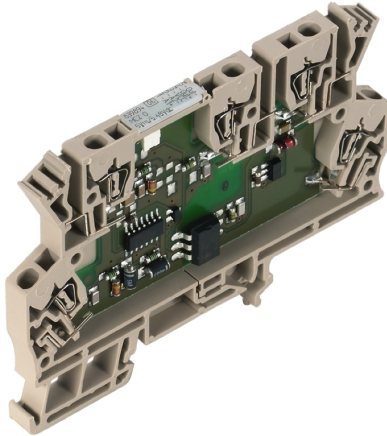

**Wiring diagram**

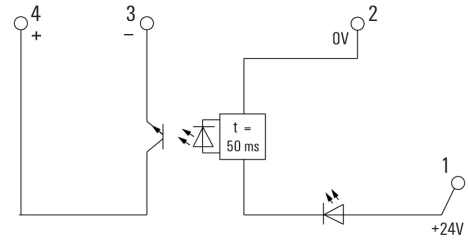

**Time functions**

off delay (watchdog)

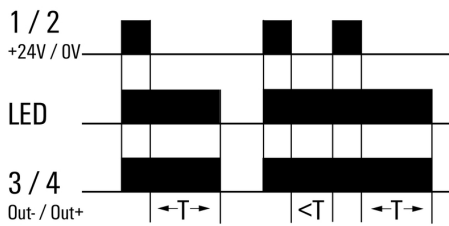

**Dimensional drawing**

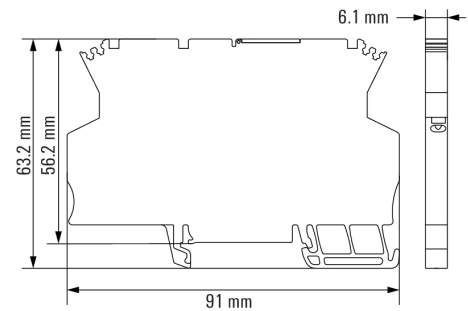

**MCZ TO 24VDC/50MS**

**Weidmüller Interface GmbH & Co. KG**  
 Klingenbergstraße 26  
 D-32758 Detmold  
 Germany

www.weidmueller.com

**Accessories**

**Slotted screwdriver**

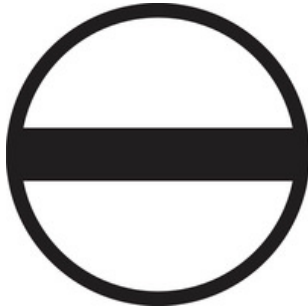

Slotted screwdriver with rounded blade SD DIN 5265, ISO 2380/2, output to DIN 5264, ISO 2380/1. ChromTop tip, SoftFinish grip

**General ordering data**

Type	SDS 0.6X3.5X100	Version
Order No.	<a href="#">2749340000</a>	Screwdriver, Blade width (B): 3.5 mm, Blade length: 100 mm, Blade thickness (A): 0.6 mm
GTIN (EAN)	4050118895568	
Qty.	1 pc(s).	

**AP MCZ 1.5 - End plate**



Open miniature housing in modular terminal format with five tension clamp connections. A transparent hinged top plate can be used for labelling and provides access to potentiometer and status displays. Plug-in cross-connectors can be used to interconnect the three top connections. A cover plate for closing off the housing is also available.

**General ordering data**

Type	AP MCZ1.5 1674	Version
Order No.	<a href="#">8389030000</a>	Small housing, OMNIMATE Housing - TERMINALBOX grey-beige, End plate, Width: 1.5 mm
GTIN (EAN)	4008190386849	
Qty.	50 pc(s).	

## MCZ TO 24VDC/50MS

**Weidmüller Interface GmbH & Co. KG**  
 Klingenbergstraße 26  
 D-32758 Detmold  
 Germany

[www.weidmueller.com](http://www.weidmueller.com)

## Accessories

## Slotted screwdriver

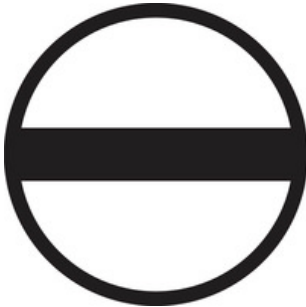

VDE insulated screwdriver sets, for working on live parts up to 1000 V AC and 1500 V DC, DIN EN 60900. IEC 900. Each piece is "GS" safety tested. Blade made from fully hardened, high-alloy chromium-vanadium-molybdenum steel, gun-metal finish.

## General ordering data

Type	SDIS SLIM 0.6X3.5X100	Version	
Order No.	<a href="#">2749610000</a>	Mounting tool, Blade width (B): 3.5 mm, Blade length: 100 mm, Blade	
GTIN (EAN)	4050118896350	thickness (A): 0.6 mm	
Qty.	1 pc(s).		

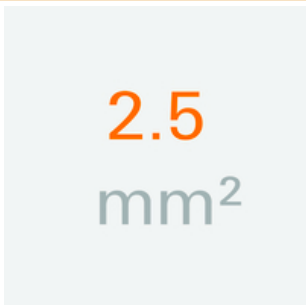
2.5 mm<sup>2</sup>

The plug-in cross-connections feature easy handling and quick installation. This saves a great deal of time during installation in comparison with screwed solutions.

## General ordering data

Type	ZQV 2.5N/20 SW	Version	
Order No.	<a href="#">1909130000</a>	W-Series, Cross-connector, For the terminals, Number of poles: 20	
GTIN (EAN)	4032248535910		
Qty.	20 pc(s).		

## MCZ TO 24VDC/50MS

**Weidmüller Interface GmbH & Co. KG**  
 Klingenbergstraße 26  
 D-32758 Detmold  
 Germany

www.weidmueller.com

## Accessories

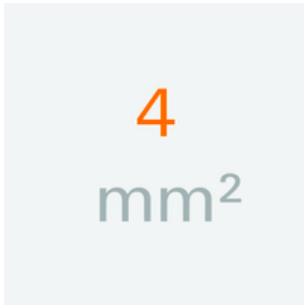
4 mm<sup>2</sup>

The plug-in cross-connections feature easy handling and quick installation. This saves a great deal of time during installation in comparison with screwed solutions.

## General ordering data

Type	ZQV 4N/20 RT	Version
Order No.	<a href="#">1909150000</a>	W-Series, Cross-connector, 32 A
GTIN (EAN)	4032248535934	
Qty.	20 pc(s).	
Type	ZQV 4N/10 BL	Version
Order No.	<a href="#">1794050000</a>	W-Series, Cross-connector, 32 A
GTIN (EAN)	4032248234011	
Qty.	20 pc(s).	
Type	ZQV 4N/10 SW	Version
Order No.	<a href="#">1794060000</a>	W-Series, Cross-connector, 32 A
GTIN (EAN)	4032248234059	
Qty.	20 pc(s).	
Type	ZQV 4N/3 BL	Version
Order No.	<a href="#">1793990000</a>	W-Series, Cross-connector, 32 A
GTIN (EAN)	4032248233786	
Qty.	60 pc(s).	
Type	ZQV 4N/2 SW	Version
Order No.	<a href="#">1793970000</a>	W-Series, Cross-connector, 32 A
GTIN (EAN)	4032248233762	
Qty.	60 pc(s).	
Type	ZQV 4N/4 GE	Version
Order No.	<a href="#">1762620000</a>	W-Series, Cross-connector, 32 A
GTIN (EAN)	4032248169771	
Qty.	60 pc(s).	
Type	ZQV 4N/4 SW	Version
Order No.	<a href="#">1794030000</a>	W-Series, Cross-connector, 32 A
GTIN (EAN)	4032248233915	
Qty.	60 pc(s).	
Type	ZQV 4N/4 RT	Version
Order No.	<a href="#">1794010000</a>	W-Series, Cross-connector, 32 A
GTIN (EAN)	4032248233809	
Qty.	60 pc(s).	
Type	ZQV 4N/2 GE	Version
Order No.	<a href="#">1758250000</a>	W-Series, Cross-connector, 32 A
GTIN (EAN)	4032248169795	
Qty.	60 pc(s).	
Type	ZQV 4N/10 GE	Version
Order No.	<a href="#">1758260000</a>	W-Series, Cross-connector, 32 A
GTIN (EAN)	4032248169764	
Qty.	20 pc(s).	

Creation date July 4, 2023 6:57:23 AM CEST

## MCZ TO 24VDC/50MS

**Weidmüller Interface GmbH & Co. KG**  
 Klingenbergstraße 26  
 D-32758 Detmold  
 Germany

www.weidmueller.com

## Accessories

Type	ZQV 4N/4 BL	Version
Order No.	<a href="#">1794020000</a>	W-Series, Cross-connector, 32 A
GTIN (EAN)	4032248233816	
Qty.	60 pc(s).	
Type	ZQV 4N/3 SW	Version
Order No.	<a href="#">1794000000</a>	W-Series, Cross-connector, 32 A
GTIN (EAN)	4032248233793	
Qty.	60 pc(s).	
Type	ZQV 4N/20 GE	Version
Order No.	<a href="#">1909020000</a>	W-Series, Cross-connector, 32 A
GTIN (EAN)	4032248535644	
Qty.	20 pc(s).	
Type	ZQV 4N/10 RT	Version
Order No.	<a href="#">1794040000</a>	W-Series, Cross-connector, 32 A
GTIN (EAN)	4032248234004	
Qty.	20 pc(s).	
Type	ZQV 4N/2 BL	Version
Order No.	<a href="#">1793960000</a>	W-Series, Cross-connector, 32 A
GTIN (EAN)	4032248233755	
Qty.	60 pc(s).	
Type	ZQV 4N/3 RT	Version
Order No.	<a href="#">1793980000</a>	W-Series, Cross-connector, 32 A
GTIN (EAN)	4032248233779	
Qty.	60 pc(s).	
Type	ZQV 4N/20 BL	Version
Order No.	<a href="#">1909100000</a>	W-Series, Cross-connector, 32 A
GTIN (EAN)	4032248535774	
Qty.	20 pc(s).	
Type	ZQV 4N/3 GE	Version
Order No.	<a href="#">1762630000</a>	W-Series, Cross-connector, 32 A
GTIN (EAN)	4032248169788	
Qty.	60 pc(s).	
Type	ZQV 4N/2 RT	Version
Order No.	<a href="#">1793950000</a>	W-Series, Cross-connector, 32 A
GTIN (EAN)	4032248233748	
Qty.	60 pc(s).	



## MCZ TO 24VDC/50MS

**Weidmüller Interface GmbH & Co. KG**  
 Klingenbergstraße 26  
 D-32758 Detmold  
 Germany

www.weidmueller.com

## Accessories

## Blank



WS markers are the perfect match for the W-series connectors. Thanks to their system compatibility, the WS tags can also be used with the I-series and the Z-series. The large marking surfaces do not only permit long character strings but also multi-line text. WS markers are ideal for labels with long, customised character strings. Thanks to the proven MultiCard format, printing with PrintJet CONNECT oder/or Plotter is possible.

- Can be fitted in strips or individually
- Markers in proven MultiCard format

**For custom printing:** Please send us a file of our labeling software M-Print PRO or M-Print PRO Online (without installation) for your labeling specifications.

## General ordering data

Type	WS 10/6 MC NE WS	Version
Order No.	<a href="#">1828450000</a>	WS, Terminal marker, 10 x 6 mm, Pitch in mm (P): 6.00 Weidmueller,
GTIN (EAN)	4032248350513	Allen-Bradley, white
Qty.	600 pc(s).	

## Slotted screwdriver

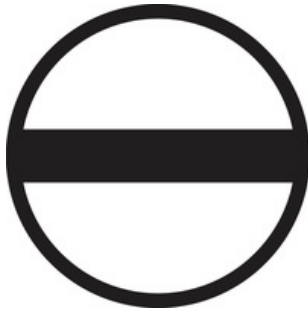

VDE insulated slot-head screwdriver, SDI DIN 7437, ISO 2380/2, drive output acc. to DIN 5264, ISO 2380/1. SoftFinish grip

## General ordering data

Type	SDIS 0.6X3.5X100	Version
Order No.	<a href="#">2749810000</a>	Screwdriver, Blade width (B): 3.5 mm, Blade length: 100 mm, Blade
GTIN (EAN)	4050118897012	thickness (A): 0.6 mm
Qty.	1 pc(s).	