





Circuit-breaker, 3p, 250A

Part no. **NZMH3-A250**
 Catalog No. **109672**

Similar to illustration

Delivery program

| | | | | |
|---|--------------------------|----|--|-----------------------------|
| Product range | | | | Circuit-breaker |
| Protective function | | | | System and cable protection |
| Standard/Approval | | | | IEC |
| Installation type | | | | Fixed |
| Release system | | | | Thermomagnetic release |
| Construction size | | | | NZM3 |
| Number of poles | | | | 3 pole |
| Standard equipment | | | | Screw connection |
| Switching capacity | | | | |
| 400/415 V 50 Hz | I_{cu} | kA | | 150 |
| Rated current = rated uninterrupted current | | | | |
| Rated current = rated uninterrupted current | $I_n = I_u$ | A | | 250 |
| Setting range | | | | |
| Overload trip | | | | |
|  | I_r | A | | 200 - 250 |
| Short-circuit releases | | | | |
|  | | | | |
| Non-delayed | | | | |
|  | $I_i = I_n \times \dots$ | | | 6 - 10 |

Technical data

General

| | | | | |
|---|--|------|--|--|
| Standards | | | | IEC/EN 60947 |
| Protection against direct contact | | | | Finger and back of hand proof to VDE 0106 Part 100 |
| Climatic proofing | | | | Damp heat, constant, to IEC 60068-2-78 Damp heat, cyclic, to IEC 60068-2-30 |
| Ambient temperature | | | | |
| Ambient temperature, storage | | °C | | - 40 - + 70 |
| Operation | | °C | | -25 - +70 |
| Mechanical shock resistance (10 ms half-sinusoidal shock) according to IEC 60068-2-27 | | g | | 20 (half-sinusoidal shock 20 ms) |
| Safe isolation to EN 61140 | | | | |
| Between auxiliary contacts and main contacts | | V AC | | 500 |
| between the auxiliary contacts | | V AC | | 300 |
| Weight | | kg | | 6.34 |
| Mounting position | | | | Vertical and 90° in all directions |

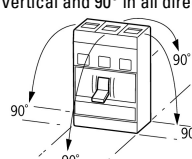

With XFI earth-fault release:

- NZM1, N1, NZM2, N2: vertical and 90° in all directions with plug-in unit
- NZM1, N1, NZM2, N2: vertical, 90° right/left with withdrawable unit:
- NZM3, N3: vertical, 90° right/left

- NZM4, N4: vertical
with remote operator:
- NZM2, N(S)2, NZM3, N(S)3,
NZM4, N(S)4: vertical and 90° in all
directions

| | | |
|--|--|--|
| Direction of incoming supply | | as required |
| Degree of protection | | |
| Device | | In the operating controls area: IP20 (basic degree of protection) |
| Enclosures | | With insulating surround: IP40 With door coupling rotary handle: IP66 |
| Terminations | | Tunnel terminal: IP10 Phase isolator and strip terminal: IP00 |
| Other technical data (sheet catalogue) | | Weight Temperature dependency, Derating Effective power loss |

Circuit-breakers

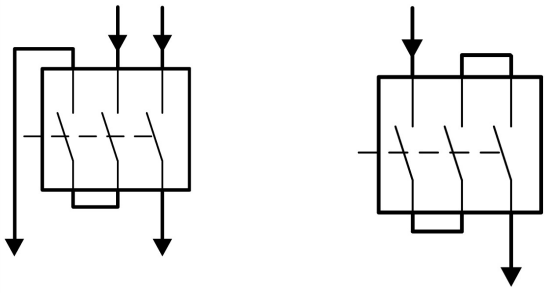
| | | | |
|---|-------------|------|---|
| Rated current = rated uninterrupted current | $I_n = I_u$ | A | 250 |
| Rated surge voltage invariability | U_{imp} | | |
| Main contacts | | V | 8000 |
| Auxiliary contacts | | V | 6000 |
| Rated operational voltage | U_e | V AC | 690 |
| Rated operational voltage | U_e | V DC | 750 |
| | | | <p>The following settings are required in order to ensure correct tripping:</p> <p>The fast-response release will take longer to respond when used for DC applications. Because of this, the setting on the trip block inscription, which is specified for AC currents, must be set to a lower value for DC currents.</p> <p>DC correction factor for instantaneous release response value:</p> <ul style="list-style-type: none"> o NZM1: 1.25 o NZM2: 1.35 o NZM3: 1.45 <p>Example: NZM3 $I_e = 500A$. Desired DC tripping current: $10 * I_e = 5000A$.</p> <p>Calculation:</p> <ul style="list-style-type: none"> • Desired DC value / correction factor = AC setting on trip block • $5000A / 1.45 = 3448 A \sim 7 * I_e =$ Value that needs to be set on the trip block <p>Permitted circuit configurations:</p> |
| | | |  |
| Overvoltage category/pollution degree | | | III/3 |
| Rated insulation voltage | U_i | V | 1000 |
| Use in unearthed supply systems | | V | ≤ 690 |

Switching capacity

| | | | |
|--|----------|----|-----|
| Rated short-circuit making capacity | I_{cm} | | |
| 240 V | I_{cm} | kA | 330 |
| 400/415 V | I_{cm} | kA | 330 |
| 440 V 50/60 Hz | I_{cm} | kA | 286 |
| 525 V 50/60 Hz | I_{cm} | kA | 143 |
| 690 V 50/60 Hz | I_c | kA | 70 |
| Rated short-circuit breaking capacity I_{cn} | I_{cn} | | |
| I_{cu} to IEC/EN 60947 test cycle O-t-CO | I_{cu} | kA | |
| 240 V 50/60 Hz | I_{cu} | kA | 150 |
| 400/415 V 50/60 Hz | I_{cu} | kA | 150 |

| | | | |
|---|-----------------|-----------------|---|
| 440 V 50/60 Hz | I _{CU} | kA | 130 |
| 525 V 50/60 Hz | I _{CU} | kA | 65 |
| 690 V 50/60 Hz | I _{CU} | kA | 35 |
| I _{CS} to IEC/EN 60947 test cycle 0-t-CO-t-CO | I _{CS} | kA | |
| 240 V 50/60 Hz | I _{CS} | kA | 150 |
| 400/415 V 50/60 Hz | I _{CS} | kA | 150 |
| 440 V 50/60 Hz | I _{CS} | kA | 130 |
| 525 V 50/60 Hz | I _{CS} | kA | 33 |
| 690 V 50/60 Hz | I _{CS} | kA | 9 |
| 500 V DC | I _{CS} | kA | 70 |
| 750 V DC | I _{CS} | kA | 70 |
| | | | Maximum back-up fuse, if the expected short-circuit currents at the installation location exceed the switching capacity of the circuit-breaker. |
| Rated short-time withstand current | | | |
| t = 0.3 s | I _{CW} | kA | 3.3 |
| t = 1 s | I _{CW} | kA | 3.3 |
| Utilization category to IEC/EN 60947-2 | | | A |
| Lifespan, mechanical(of which max. 50 % trip by shunt/undervoltage release) | | | Operations 15000 |
| Lifespan, electrical | | | |
| AC-1 | | | |
| 400 V 50/60 Hz | Operations | | 5000 |
| 415 V 50/60 Hz | Operations | | 5000 |
| 690 V 50/60 Hz | Operations | | 3000 |
| AC--3 | | | |
| 400 V 50/60 Hz | Operations | | 2000 |
| 415 V 50/60 Hz | Operations | | 2000 |
| 690 V 50/60 Hz | Operations | | 2000 |
| Max. operating frequency | | Ops/h | 60 |
| Total break time at short-circuit | | ms | < 10 |
| Terminal capacity | | | |
| Standard equipment | | | Screw connection |
| Optional accessories | | | Box terminal Tunnel terminal connection on rear |
| Round copper conductor | | | |
| Box terminal | | | |
| Solid | | mm ² | 2 x 16 |
| Stranded | | mm ² | 1 x (35 - 240) 2 x (25-120) |
| Tunnel terminal | | | |
| Solid | | mm ² | 1 x 16 |
| Stranded | | | |
| 1-hole | | mm ² | 1 x (16 - 185) |
| Bolt terminal and rear-side connection | | | |
| Direct on the switch | | | |
| Solid | | mm ² | 1 x 16 2 x 16 |
| Stranded | | mm ² | 1 x (25 - 240) 2 x (25 - 240) |
| Connection width extension | | mm ² | |
| Connection width extension | | mm ² | 2 x 300 |
| Al circular conductor | | | |
| Tunnel terminal | | | |
| Solid | | mm ² | 1 x 16 |
| Stranded | | | |
| Stranded | | mm ² | 1 x (25 - 185) ²⁾ |

| | | | |
|---|------|-----------------|--|
| Double hole | | mm ² | 1 x (50 - 240) 2 x (50 - 240) |
| | | | 2) Up to 240 mm ² can be connected depending on the cable manufacturer. |
| Cu strip (number of segments x width x segment thickness) | | | |
| Box terminal | | | |
| | min. | mm | 6 x 16 x 0.8 |
| | max. | mm | 10 x 24 x 1.0 + 5 x 24 x 1.0 (2 x) 8 x 24 x 1.0 |
| Bolt terminal and rear-side connection | | | |
| Flat copper strip, with holes | min. | mm | 6 x 16 x 0.8 |
| Flat copper strip, with holes | max. | mm | 10 x 32 x 1.0 + 5 x 32 x 1.0 |
| Connection width extension | | mm | (2 x) 10 x 50 x 1.0 |
| Copper busbar (width x thickness) | | mm | |
| Bolt terminal and rear-side connection | | | |
| Screw connection | | | M10 |
| Direct on the switch | | | |
| | min. | mm | 20 x 5 |
| | max. | mm | 30 x 10 + 30 x 5 |
| Connection width extension | | mm | |
| Connection width extension | max. | mm | 2 x (10 x 50) |
| Control cables | | | |
| | | mm ² | 1 x (0.75 - 2.5) 2 x (0.75 - 1.5) |

Design verification as per IEC/EN 61439

| | | | |
|--|------------------|----|--|
| Technical data for design verification | | | |
| Rated operational current for specified heat dissipation | I _n | A | 250 |
| Equipment heat dissipation, current-dependent | P _{vid} | W | 68.25 |
| Operating ambient temperature min. | | °C | -25 |
| Operating ambient temperature max. | | °C | 70 |
| IEC/EN 61439 design verification | | | |
| 10.2 Strength of materials and parts | | | |
| 10.2.2 Corrosion resistance | | | Meets the product standard's requirements. |
| 10.2.3.1 Verification of thermal stability of enclosures | | | Meets the product standard's requirements. |
| 10.2.3.2 Verification of resistance of insulating materials to normal heat | | | Meets the product standard's requirements. |
| 10.2.3.3 Verification of resistance of insulating materials to abnormal heat and fire due to internal electric effects | | | Meets the product standard's requirements. |
| 10.2.4 Resistance to ultra-violet (UV) radiation | | | Meets the product standard's requirements. |
| 10.2.5 Lifting | | | Does not apply, since the entire switchgear needs to be evaluated. |
| 10.2.6 Mechanical impact | | | Does not apply, since the entire switchgear needs to be evaluated. |
| 10.2.7 Inscriptions | | | Meets the product standard's requirements. |
| 10.3 Degree of protection of ASSEMBLIES | | | Does not apply, since the entire switchgear needs to be evaluated. |
| 10.4 Clearances and creepage distances | | | Meets the product standard's requirements. |
| 10.5 Protection against electric shock | | | Does not apply, since the entire switchgear needs to be evaluated. |
| 10.6 Incorporation of switching devices and components | | | Does not apply, since the entire switchgear needs to be evaluated. |
| 10.7 Internal electrical circuits and connections | | | Is the panel builder's responsibility. |
| 10.8 Connections for external conductors | | | Is the panel builder's responsibility. |
| 10.9 Insulation properties | | | |
| 10.9.2 Power-frequency electric strength | | | Is the panel builder's responsibility. |
| 10.9.3 Impulse withstand voltage | | | Is the panel builder's responsibility. |
| 10.9.4 Testing of enclosures made of insulating material | | | Is the panel builder's responsibility. |
| 10.10 Temperature rise | | | The panel builder is responsible for the temperature rise calculation. Eaton will provide heat dissipation data for the devices. |
| 10.11 Short-circuit rating | | | Is the panel builder's responsibility. The specifications for the switchgear must be observed. |
| 10.12 Electromagnetic compatibility | | | Is the panel builder's responsibility. The specifications for the switchgear must be observed. |

Technical data ETIM 7.0

Low-voltage industrial components (EG000017) / Power circuit-breaker for trafo/generator/installation protection (EC000228)

Electric engineering, automation, process control engineering / Low-voltage switch technology / Circuit breaker (LV < 1 kV) / Circuit breaker for power transformer, generator and system protection (ecl@ss10.0.1-27-37-04-09 [AJZ716013])

| | | |
|---|----|--|
| Rated permanent current I _u | A | 250 |
| Rated voltage | V | 690 - 690 |
| Rated short-circuit breaking capacity I _{cu} at 400 V, 50 Hz | kA | 150 |
| Overload release current setting | A | 200 - 250 |
| Adjustment range short-term delayed short-circuit release | A | 0 - 0 |
| Adjustment range undelayed short-circuit release | A | 1500 - 2500 |
| Integrated earth fault protection | | No |
| Type of electrical connection of main circuit | | Screw connection |
| Device construction | | Built-in device fixed built-in technique |
| Suitable for DIN rail (top hat rail) mounting | | No |
| DIN rail (top hat rail) mounting optional | | No |
| Number of auxiliary contacts as normally closed contact | | 0 |
| Number of auxiliary contacts as normally open contact | | 0 |
| Number of auxiliary contacts as change-over contact | | 0 |
| With switched-off indicator | | No |
| With under voltage release | | No |
| Number of poles | | 3 |
| Position of connection for main current circuit | | Front side |
| Type of control element | | Rocker lever |
| Complete device with protection unit | | Yes |
| Motor drive integrated | | No |
| Motor drive optional | | Yes |
| Degree of protection (IP) | | IP20 |

Characteristics

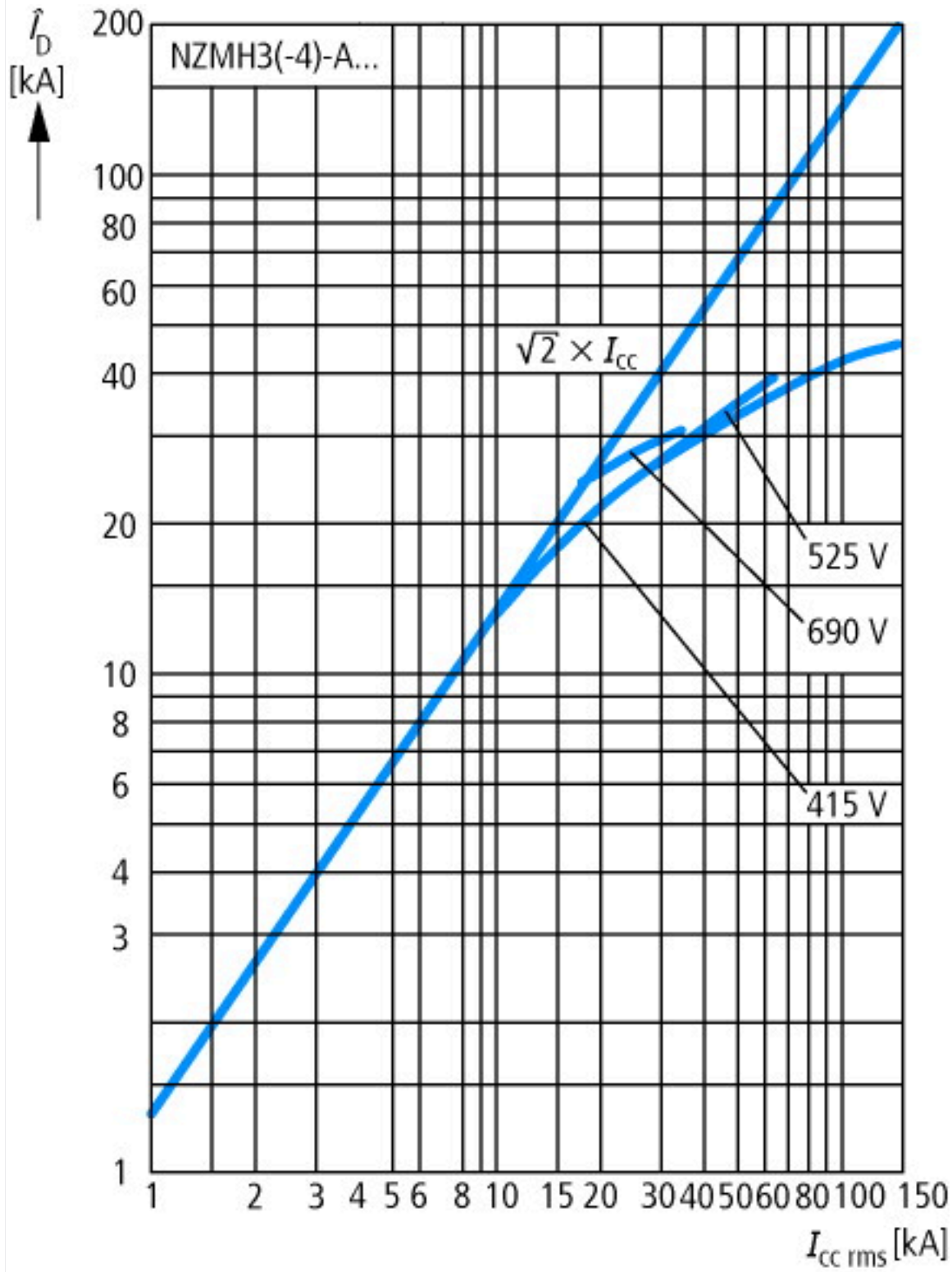

Let-through current



Let-through energy

Dimensions

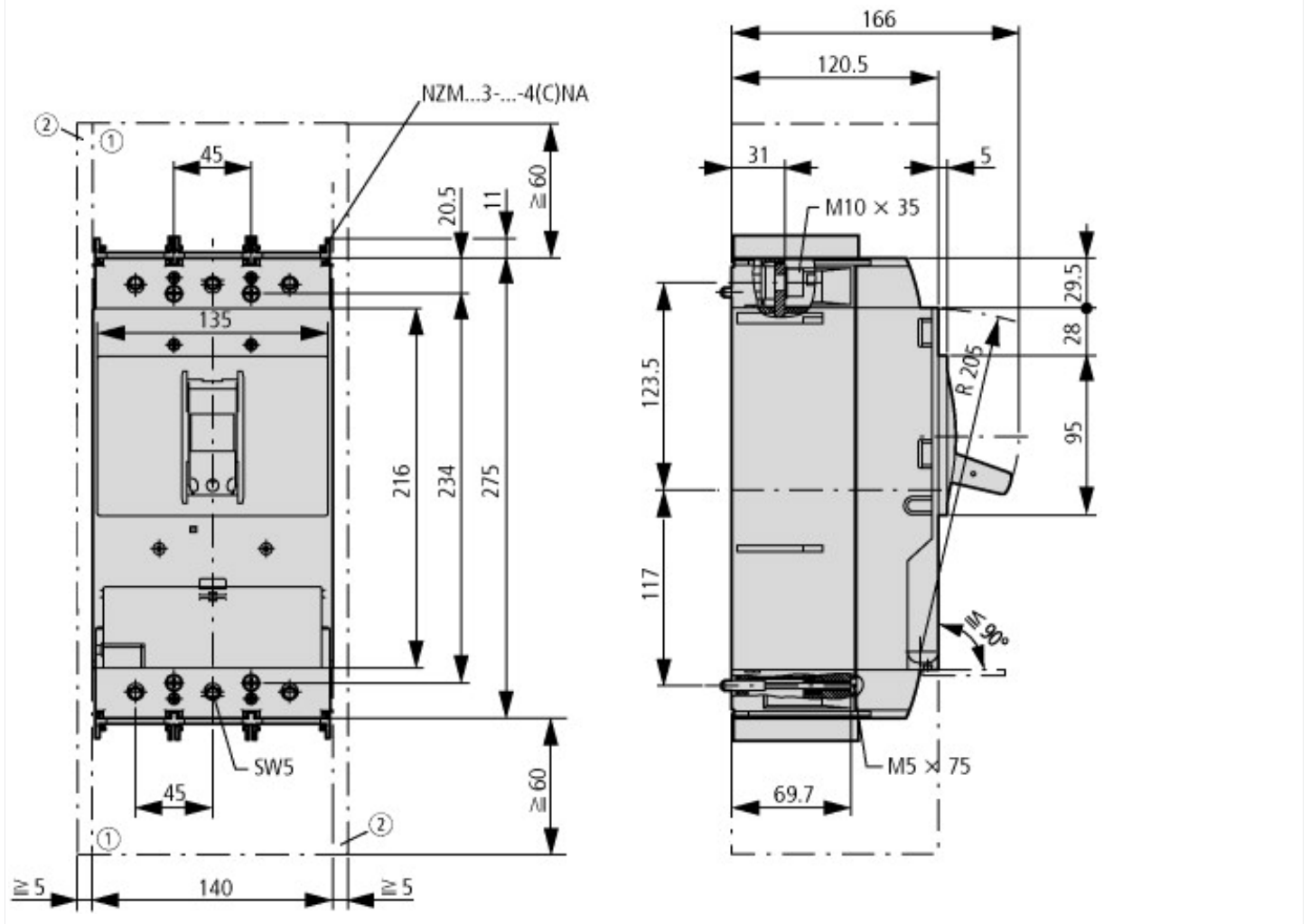

- ① Blow out area, minimum clearance to adjacent parts
- ② Minimum clearance to adjacent parts



Additional product information (links)

IL01208009Z (AWA1230-1992) Circuit-Breaker, basic unit

| | |
|--|---|
| IL01208009Z (AWA1230-1992) Circuit-Breaker, basic unit | https://es-assets.eaton.com/DOCUMENTATION/AWA_INSTRUCTIONS/IL01208009Z2018_11.pdf |
| Weight | http://ecat.moeller.net/flip-cat/?edition=HPLEN&startpage=17.171 |
| Temperature dependency, Derating | http://ecat.moeller.net/flip-cat/?edition=HPLEN&startpage=17.172 |
| Effective power loss | http://ecat.moeller.net/flip-cat/?edition=HPLEN&startpage=17.174 |
| additional technical information for NZM power switch | https://es-assets.eaton.com/DOCUMENTATION/PDF/nzm_technic_de_en.pdf |