



Switch-disconnector 3p 63A +pull out

Part no. N1-63-SVE
Catalog No. 113729
EL-Nummer (Norway) 0004357989

Delivery program

Product range			Switch-disconnectors
Protective function			Disconnectors/main switches
Standard/Approval			IEC
Installation type			Plug-in units
Construction size			N1
Description			Main switch characteristics including positive drive to IEC/EN 60204 and VDE 0113. Isolating characteristics to IEC/EN 60947-3 and VDE 0660. Busbar tag shroud to VDE 0160 Part 100.
Number of poles			3 pole
Switch positions			I, +, 0
Rated current = rated uninterrupted current	$I_n = I_u$	A	63
Short-circuit protection max. fuse gL-characteristic		A gL	125

Technical data

General

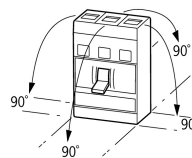
Standards			IEC/EN 60947
Protection against direct contact			Finger and back-of-hand proof to DIN EN 50274/VDE 0106 part 110
Climatic proofing			Damp heat, constant, to IEC 60068-2-78 Damp heat, cyclic, to IEC 60068-2-30
Ambient temperature			
Ambient temperature, storage		°C	- 40 - + 70
Operation		°C	-25 - +70
Mechanical shock resistance (10 ms half-sinusoidal shock) according to IEC 60068-2-27		g	20 (half-sinusoidal shock 20 ms)
Safe isolation to EN 61140			
Between auxiliary contacts and main contacts		V AC	500
between the auxiliary contacts		V AC	300
Mounting position			
Mounting position			Vertical and 90° in all directions  With residual-current release XFI: - NZM1, N1, NZM2, N2: vertical and 90° in all directions with plug-in adapter elements - NZM1, N1, NZM2, N2: vertical, 90° right/left with withdrawable unit: - NZM3, N3: vertical, 90 ° left - NZM4, N4: vertical with remote operator: - NZM2, N(S)2, NZM3, N(S)3, NZM4, N(S)4: vertical and 90° in all directions
Direction of incoming supply			as required
Degree of protection			
Device			In the area of the HMI devices: IP20 (basic protection type)
Enclosures			With insulating surround: IP40 With door coupling rotary handle: IP66
Terminations			Tunnel terminal: IP10 Phase isolator and band terminal: IP00

Switch-disconnectors

Rated surge voltage invariability	U_{imp}		
-----------------------------------	-----------	--	--

Main contacts	V	6000
Auxiliary contacts	V	6000
Rated operational voltage	U _e	V AC 690
Rated operating frequency	f	Hz 50/60
Rated current = rated uninterrupted current	I _n = I _u	A 63
Overvoltage category/pollution degree		III/3
Rated insulation voltage	U _i	V 690
Use in unearthed supply systems	V	≤ 690
Other technical data (sheet catalogue)		Weight Temperature dependency, Derating Effective power loss

Rated short-circuit making capacity

690 V 50/60 H	I _c	kA	2.8
---------------	----------------	----	-----

Rated short-time withstand current

t = 0.3 s	I _{cw}	kA	2
t = 1 s	I _{cw}	kA	2

Rated conditional short-circuit current

With back-up fuse		A gG/gL	gG/gL: 63
400 ... 415 V		kA	100
690 V		kA	80
With downstream fuse		A gG/gL	gG/gL: 63
400 ... 415 V		kA	100
690 V		kA	10

Rated making and breaking capacity

Rated operational current	I _e	A	
AC-22/23A			
415 V	I _e	A	160
690 V	I _e	A	160
Lifespan, mechanical	Operations		20000
Max. operating frequency		Ops/h	120

Lifespan, electrical

AC-1			
400 V 50/60 Hz	Operations		10000
415 V 50/60 Hz	Operations		10000
690 V 50/60 Hz	Operations		7500
AC-23A			
400 V 50/60 Hz	Operations		1000
415 V 50/60 Hz	Operations		1000
690 V 50/60 Hz	Operations		1000

Terminal capacity

Accessories required			NZM1-XSVS socket base
Copper conductors and cables			
Box terminal			
Solid		mm ²	1 x (10 - 16) 2 x (6 - 16)
Stranded		mm ²	1 x (10 - 70) ³⁾ 2 x (6 - 25)
			³⁾ Up to 95 mm ² can be connected depending on the cable manufacturer.
Tunnel terminal			
Solid		mm ²	1 x 16
Stranded			
1-hole		mm ²	1 x (25 - 95)
Bolt terminal and rear-side connection			
Direct on the switch			
Solid		mm ²	1 x (10 - 16) 2 x (6 - 16)
Stranded		mm ²	1 x (25 - 70) ³⁾ 2 x 25

			3) Up to 95 mm ² can be connected depending on the cable manufacturer.
Al conductors, Al cable			
Tunnel terminal			
Solid		mm ²	1 x 16
Stranded			
1-hole		mm ²	1 x (25 - 95)
Bolt terminal and rear-side connection			
Direct on the switch			
Solid		mm ²	1 x (10 - 16) 2 x (10 - 16)
Stranded		mm ²	1 x (25 - 70) ³⁾ 2 x 25
Cu strip (number of segments x width x segment thickness)			
Box terminal			
	min.	mm	2 x 9 x 0.8
	max.	mm	9 x 9 x 0.8
Copper busbar (width x thickness)			
Bolt terminal and rear-side connection			
Screw connection			M6
Direct on the switch			
	min.	mm	12 x 5
	max.	mm	16 x 5

Design verification as per IEC/EN 61439

Technical data for design verification			
Rated operational current for specified heat dissipation	I _n	A	63
Equipment heat dissipation, current-dependent	P _{vid}	W	4.52
Operating ambient temperature min.		°C	-25
Operating ambient temperature max.		°C	70
IEC/EN 61439 design verification			
10.2 Strength of materials and parts			
10.2.2 Corrosion resistance			
Meets the product standard's requirements.			
10.2.3.1 Verification of thermal stability of enclosures			
Meets the product standard's requirements.			
10.2.3.2 Verification of resistance of insulating materials to normal heat			
Meets the product standard's requirements.			
10.2.3.3 Verification of resistance of insulating materials to abnormal heat and fire due to internal electric effects			
Meets the product standard's requirements.			
10.2.4 Resistance to ultra-violet (UV) radiation			
Meets the product standard's requirements.			
10.2.5 Lifting			
Does not apply, since the entire switchgear needs to be evaluated.			
10.2.6 Mechanical impact			
Does not apply, since the entire switchgear needs to be evaluated.			
10.2.7 Inscriptions			
Meets the product standard's requirements.			
10.3 Degree of protection of ASSEMBLIES			
Does not apply, since the entire switchgear needs to be evaluated.			
10.4 Clearances and creepage distances			
Meets the product standard's requirements.			
10.5 Protection against electric shock			
Does not apply, since the entire switchgear needs to be evaluated.			
10.6 Incorporation of switching devices and components			
Does not apply, since the entire switchgear needs to be evaluated.			
10.7 Internal electrical circuits and connections			
Is the panel builder's responsibility.			
10.8 Connections for external conductors			
Is the panel builder's responsibility.			
10.9 Insulation properties			
10.9.2 Power-frequency electric strength			
Is the panel builder's responsibility.			
10.9.3 Impulse withstand voltage			
Is the panel builder's responsibility.			
10.9.4 Testing of enclosures made of insulating material			
Is the panel builder's responsibility.			
10.10 Temperature rise			
The panel builder is responsible for the temperature rise calculation. Eaton will provide heat dissipation data for the devices.			
10.11 Short-circuit rating			
Is the panel builder's responsibility. The specifications for the switchgear must be observed.			
10.12 Electromagnetic compatibility			
Is the panel builder's responsibility. The specifications for the switchgear must be observed.			

Technical data ETIM 7.0

Low-voltage industrial components (EG000017) / Switch disconnecter (EC000216)			
Electric engineering, automation, process control engineering / Low-voltage switch technology / Off-load switch, circuit breaker, control switch / Switch disconnecter (ec1@ss10.0.1-27-37-14-03 [AKF060013])			
Version as main switch			Yes
Version as maintenance-/service switch			Yes
Version as safety switch			No
Version as emergency stop installation			Yes
Version as reversing switch			No
Number of switches			1
Max. rated operation voltage U _e AC	V		690
Rated operating voltage	V		690 - 690
Rated permanent current I _u	A		63
Rated permanent current at AC-23, 400 V	A		0
Rated permanent current at AC-21, 400 V	A		0
Rated operation power at AC-3, 400 V	kW		0
Rated short-time withstand current I _{cw}	kA		2
Rated operation power at AC-23, 400 V	kW		30
Switching power at 400 V	kW		0
Conditioned rated short-circuit current I _q	kA		0
Number of poles			3
Number of auxiliary contacts as normally closed contact			0
Number of auxiliary contacts as normally open contact			0
Number of auxiliary contacts as change-over contact			0
Motor drive optional			Yes
Motor drive integrated			No
Voltage release optional			Yes
Device construction			Built-in device plug-in technique
Suitable for ground mounting			Yes
Suitable for front mounting 4-hole			No
Suitable for front mounting centre			No
Suitable for distribution board installation			Yes
Suitable for intermediate mounting			Yes
Colour control element			Black
Type of control element			Rocker lever
Interlockable			Yes
Type of electrical connection of main circuit			Frame clamp
Degree of protection (IP), front side			IP20
Degree of protection (NEMA)			

Dimensions

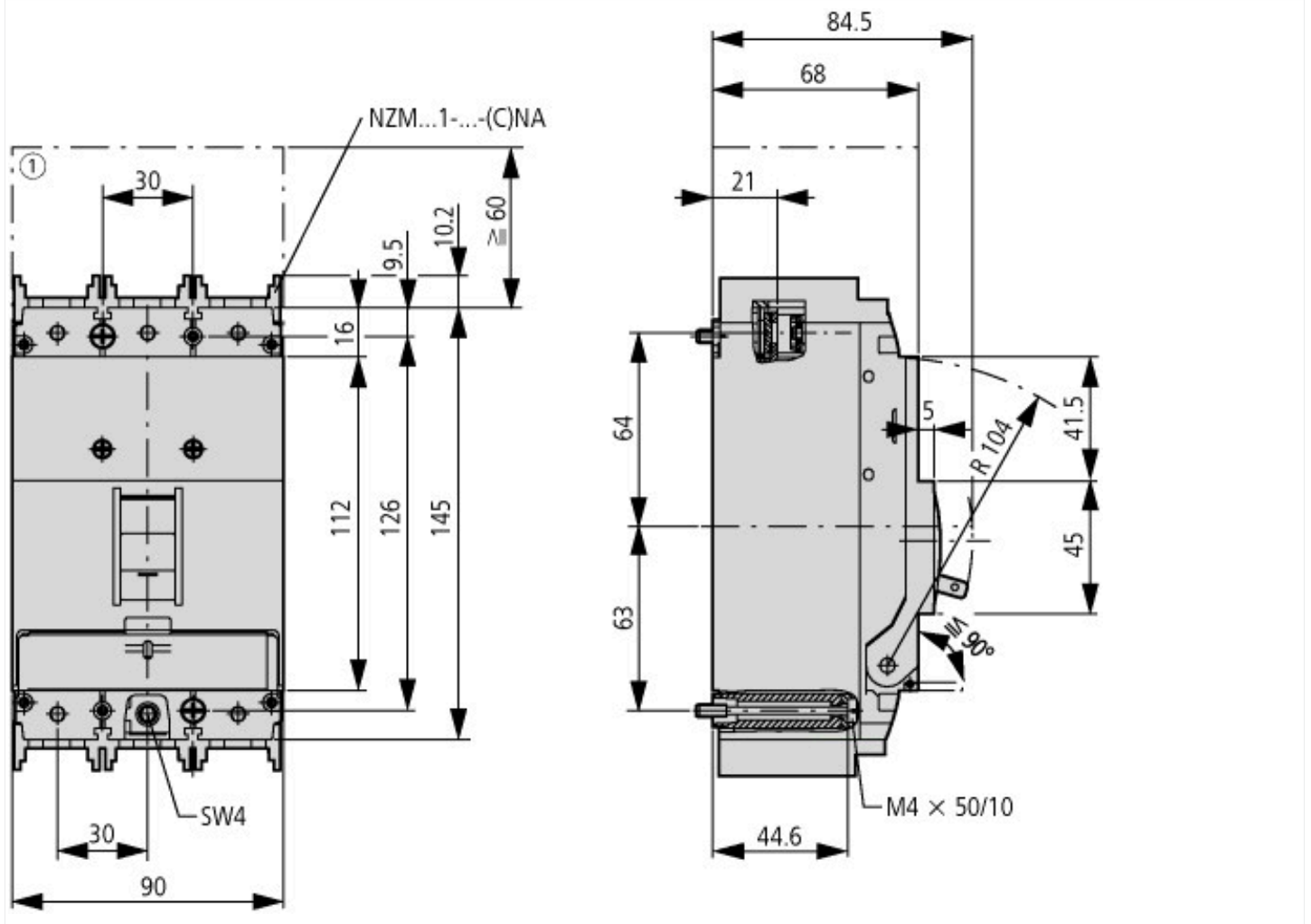

① Blow out area, minimum clearance to adjacent parts

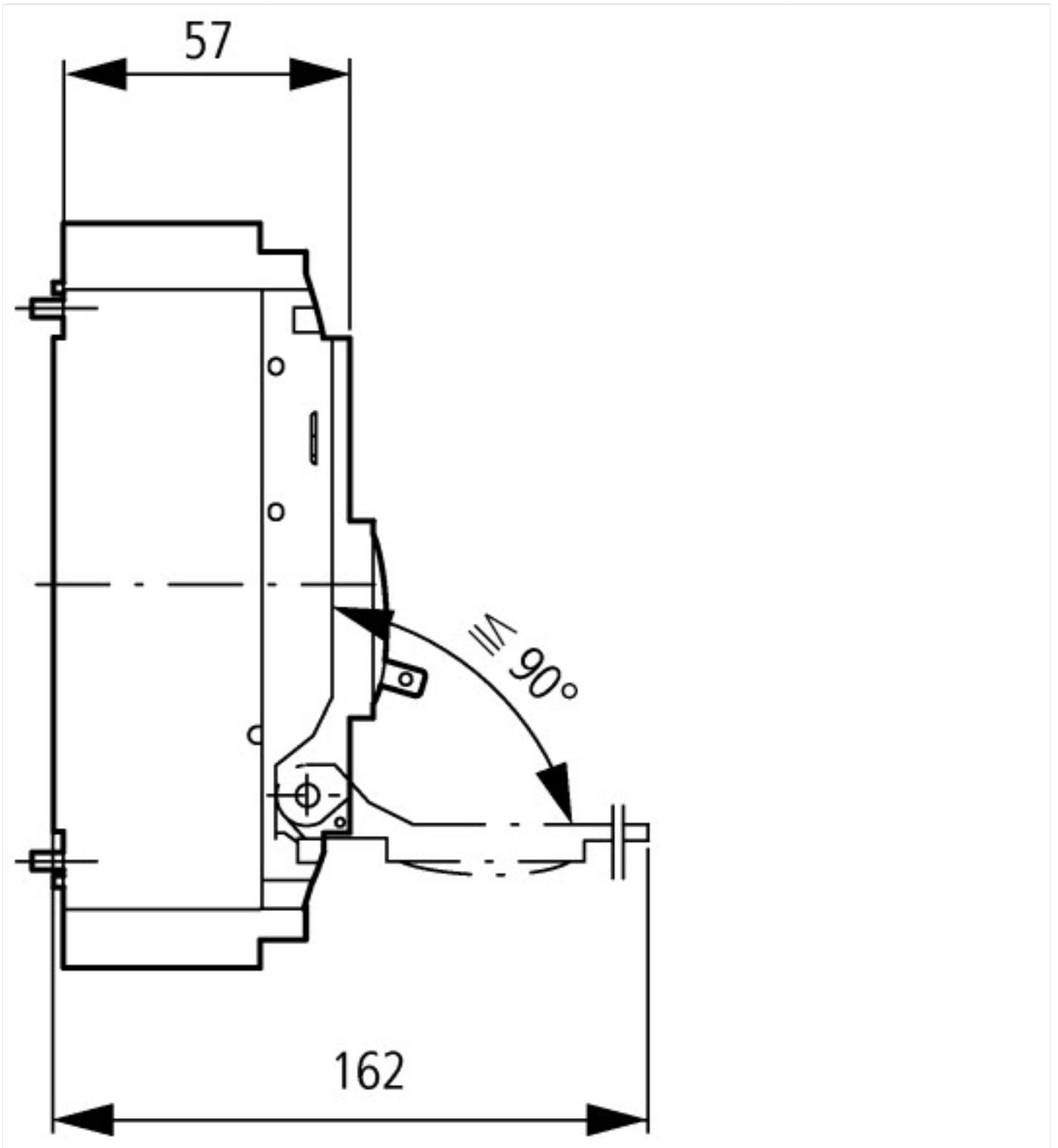

Additional product information (links)

Weight	http://ecat.moeller.net/flip-cat/?edition=HPLEN&startpage=17.171
Temperature dependency, Derating	http://ecat.moeller.net/flip-cat/?edition=HPLEN&startpage=17.172
Effective power loss	http://ecat.moeller.net/flip-cat/?edition=HPLEN&startpage=17.174
CurveSelect characteristics program	http://www.eaton.eu/DE/Europe/Electrical/CustomerSupport/ConfigurationTools/CharacteristicsProgram/index.htm
Eaton configurator	http://www.eaton.eu/DE/Europe/Electrical/CustomerSupport/ConfigurationTools/ConfiguratorCircuitBreaker/index.htm
additional technical information for NZM power switch	https://es-assets.eaton.com/DOCUMENTATION/PDF/nzm_technic_de_en.pdf