







Changeover switch, With thumb-grip, momentary, 1 NC, 1 N/O, Screw connection, 2 positions, Bezel: black

Part no. C22S-WK-K11
Catalog No. 121586
Alternate Catalog No. C22S-WK-K11

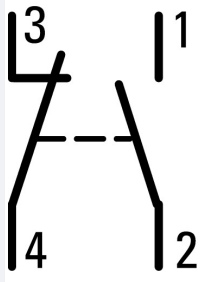
Delivery program

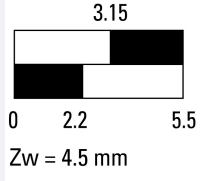
Product range			RMQ Compact
Basic function			Selector switch actuators
Single unit/Complete unit			Complete unit
Design			With thumb-grip momentary
Function:			
			 40°
Connection type			Screw connection 2 positions
Degree of Protection			IP65
Front ring			Bezel: black
Connection to SmartWire-DT			no
Contacts			
N/C = Normally closed			1 NC 
N/O = Normally open			1 N/O
Notes			 = safety function, by positive opening to IEC/EN 60947-5-1
Actuator travel and actuation force as per DIN EN 60947-5-1, K.5.4.1			
	mm		4.65
Maximum travel	mm		5.7
Minimum force for positive opening	N		20
Contact sequence			
Contact travel  = Contact closed  = Contact open			
Contact diagram			
Positive opening (ZW)			yes

Technical data

General			
Standards			IEC/EN 60947-5-1 VDE 0660
Lifespan, mechanical	Operations	x 10 ⁶	> 1
Operating frequency	Operations/h		≤ 2000

Operating torque		Nm	≤ 0.3
Climatic proofing			Damp heat, constant, to IEC 60068-2-78 Damp heat, cyclic, to IEC 60068-2-30
Degree of Protection			IP65
Mounting position			As required
Terminal capacities		mm ²	
Solid		mm ²	2 x 0.5 - 1.5
Flexible with ferrule		mm ²	2 x 0.5 - 1.5
Tightening torque for terminal screw		Nm	0.8

Contacts

Rated impulse withstand voltage	U _{imp}	V AC	4000
Rated insulation voltage	U _i	V	250
Rated conditional short-circuit current	I _q	kA	1
Overvoltage category/pollution degree			III/3
Control circuit reliability			
at 24 V DC/5 mA	H _F	Fault probability	values follow
at 5 V DC/1 mA	H _F	Fault probability	values follow
Max. short-circuit protective device			
Fuse	gG/gL	A	10

Technical data ETIM 7.0

Low-voltage industrial components (EG000017) / Selector switch, complete (EC001029)			
Electric engineering, automation, process control engineering / Low-voltage switch technology / Command and alarm device / Selector switch, complete unit (ecl@ss10.0.1-27-37-12-43 [ACN984011])			
Number of switch positions			2
Type of control element			Toggle
Suitable for illumination			No
With light source			No
Colour button			Black
Hole diameter		mm	22.5
Width opening		mm	0
Height opening		mm	0
Switching function latching			No
Spring-return			Yes
Degree of protection (IP)			IP65
Degree of protection (NEMA)			
Supply voltage		V	0 - 0
Number of contacts as normally open contact			1
Number of contacts as normally closed contact			1
Number of contacts as change-over contact			0
Type of electric connection			Screw connection
With front ring			Yes
Material front ring			Plastic
Colour front ring			Other

Approvals

Product Standards			IEC/EN 60947-5-1; UL 508; CAN/CSA-C22.2 No. 14-05 und 94-M91; CE marking
UL File No.			E29184
UL Category Control No.			NKCR
CSA File No.			165628
CSA Class No.			321103
North America Certification			UL listed, CSA certified
Degree of Protection			1,3R,4X,12,13

Dimensions

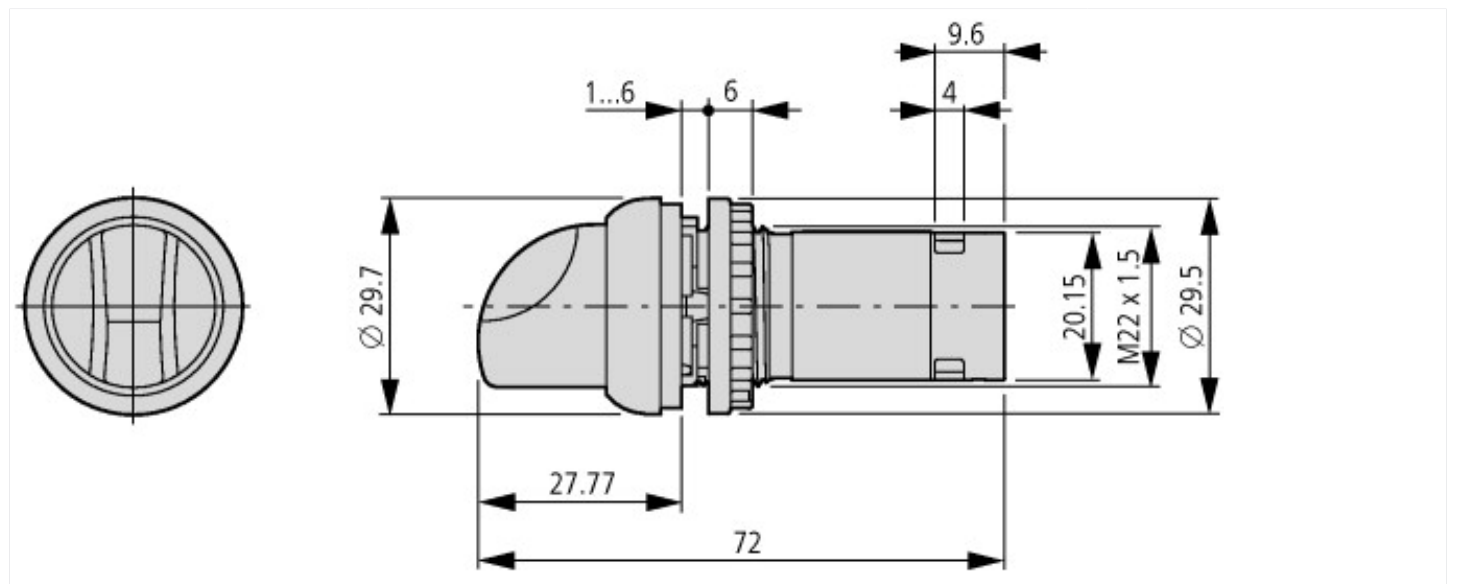

Additional product information (links)

IL04716025Z RMQ-Titan: compact programm

IL04716025Z RMQ-Titan: compact programm https://es-assets.eaton.com/DOCUMENTATION/AWA_INSTRUCTIONS/IL04716025Z2019_05.pdf