







**Changeover switch, With thumb-grip, maintained, 2 NC, Screw connection, 2 positions, Bezel: black**

**Part no.** C22S-WRK-K02  
**Catalog No.** 121590  
**Alternate Catalog No.** C22S-WRK-K02

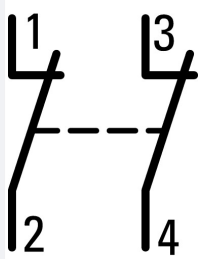
**Delivery program**

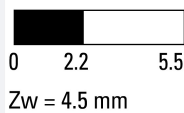
Product range			RMQ Compact
Basic function			Selector switch actuators
Single unit/Complete unit			Complete unit
Design			With thumb-grip maintained
<b>Function:</b>			
			↙ 60°
Connection type			Screw connection 2 positions
Degree of Protection			IP65
Front ring			Bezel: black
Connection to SmartWire-DT			no
<b>Contacts</b>			
N/C = Normally closed			2 NC 
Notes			 = safety function, by positive opening to IEC/EN 60947-5-1
<b>Actuator travel and actuation force as per DIN EN 60947-5-1, K.5.4.1</b>			
	mm		4.65
Maximum travel	mm		5.7
Minimum force for positive opening	N		30
Contact sequence			
<b>Contact travel  = Contact closed  = Contact open</b>			
Contact diagram			
Positive opening (ZW)			yes

**Technical data**

<b>General</b>			
Standards			IEC/EN 60947-5-1 VDE 0660
Lifespan, mechanical	Operations	x 10 <sup>6</sup>	> 1
Operating frequency	Operations/h		≤ 2000
Operating torque		Nm	≤ 0.3
Climatic proofing			Damp heat, constant, to IEC 60068-2-78 Damp heat, cyclic, to IEC 60068-2-30

Degree of Protection			IP65
Mounting position			As required
Terminal capacities		mm <sup>2</sup>	
Solid		mm <sup>2</sup>	2 x 0.5 - 1.5
Flexible with ferrule		mm <sup>2</sup>	2 x 0.5 - 1.5
Tightening torque for terminal screw		Nm	0.8

### Contacts

Rated impulse withstand voltage	U <sub>imp</sub>	V AC	4000
Rated insulation voltage	U <sub>i</sub>	V	250
Rated conditional short-circuit current	I <sub>q</sub>	kA	1
Overvoltage category/pollution degree			III/3
Control circuit reliability			
at 24 V DC/5 mA	H <sub>F</sub>	Fault probability	values follow
at 5 V DC/1 mA	H <sub>F</sub>	Fault probability	values follow
Max. short-circuit protective device			
Fuse	gG/gL	A	10

## Technical data ETIM 7.0

Low-voltage industrial components (EG000017) / Selector switch, complete (EC001029)

Electric engineering, automation, process control engineering / Low-voltage switch technology / Command and alarm device / Selector switch, complete unit (ecl@ss10.0.1-27-37-12-43 [ACN984011])

Number of switch positions			2
Type of control element			Toggle
Suitable for illumination			No
With light source			No
Colour button			Black
Hole diameter		mm	22.5
Width opening		mm	0
Height opening		mm	0
Switching function latching			Yes
Spring-return			No
Degree of protection (IP)			IP65
Degree of protection (NEMA)			
Supply voltage		V	0 - 0
Number of contacts as normally open contact			0
Number of contacts as normally closed contact			2
Number of contacts as change-over contact			0
Type of electric connection			Screw connection
With front ring			Yes
Material front ring			Plastic
Colour front ring			Other

## Approvals

Product Standards			IEC/EN 60947-5-1; UL 508; CAN/CSA-C22.2 No. 14-05 und 94-M91; CE marking
UL File No.			E29184
UL Category Control No.			NKCR
CSA File No.			165628
CSA Class No.			321103
North America Certification			UL listed, CSA certified
Degree of Protection			1,3R,4X,12,13

## Dimensions

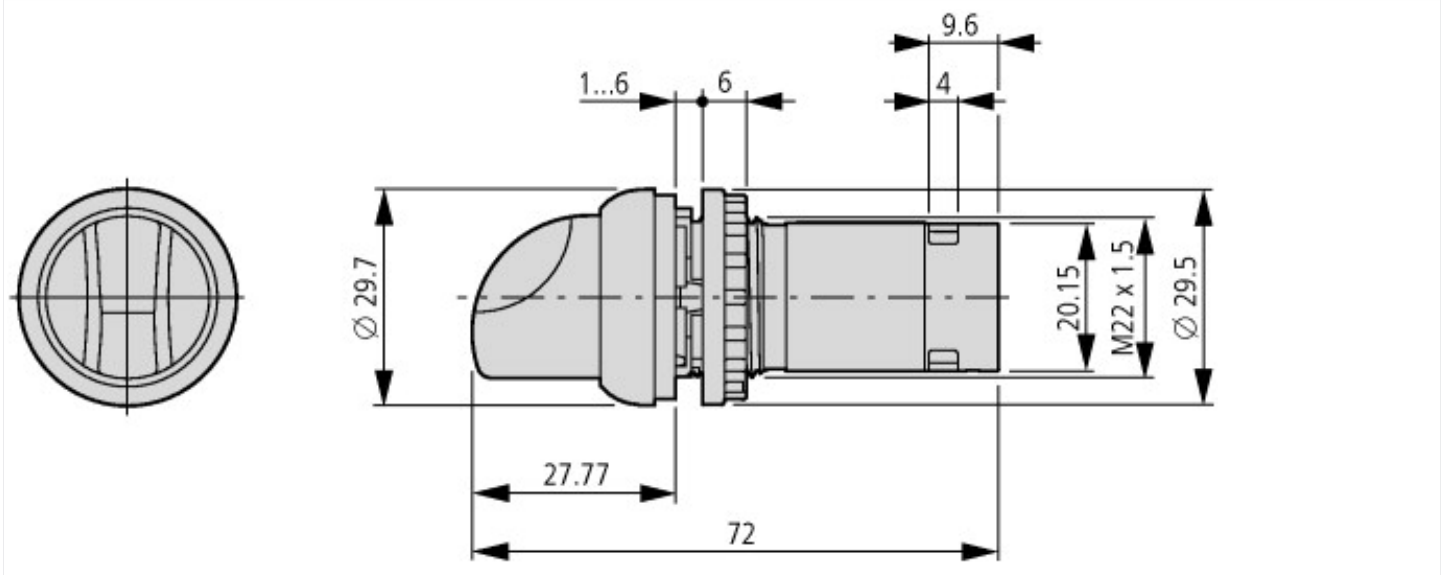

## Additional product information (links)

IL04716025Z RMQ-Titan: compact programm

IL04716025Z RMQ-Titan: compact programm [https://es-assets.eaton.com/DOCUMENTATION/AWA\\_INSTRUCTIONS/IL04716025Z2019\\_05.pdf](https://es-assets.eaton.com/DOCUMENTATION/AWA_INSTRUCTIONS/IL04716025Z2019_05.pdf)