





Pushbutton, Flat, momentary, 2 NC, Screw connection, red, inscribed, Bezel: titanium

Part no. C22-D-R-X0-K02
Catalog No. 132424
Alternate Catalog No. C22-D-R-X0-K02

Delivery program

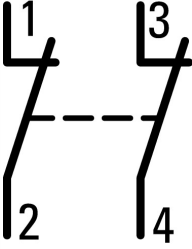
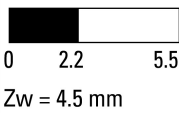
Product range			RMQ Compact
Basic function			Pushbutton actuators
Single unit/Complete unit			Complete unit
Design			Flat
			momentary
Connection type			Screw connection
Button plate			
button plate			red
Button plate			
			inscribed
Name			0
Degree of Protection			IP66, IP67, IP69
Front ring			Bezel: titanium
Connection to SmartWire-DT			no
Contacts			
N/C = Normally closed			2 NC 
Notes			 = safety function, by positive opening to IEC/EN 60947-5-1
Actuator travel and actuation force as per DIN EN 60947-5-1, K.5.4.1			
	mm		4.65
Maximum travel	mm		5.7
Minimum force for positive opening	N		30
Contact sequence			
Contact travel <input checked="" type="checkbox"/> = Contact closed <input type="checkbox"/> = Contact open			
Contact diagram			 Zw = 4.5 mm
Positive opening (ZW)			yes

Technical data

General		
Standards		IEC/EN 60947-5-1

			VDE 0660
Lifespan, mechanical	Operations	x 10 ⁶	> 5
Operating frequency	Operations/h		≅ 3600
Actuating force	n		≅ 5
Climatic proofing			Damp heat, constant, to IEC 60068-2-78 Damp heat, cyclic, to IEC 60068-2-30
Degree of Protection			IP66, IP67, IP69
Ambient temperature			
Open	°C		-25 - +70
Storage	°C		- -30 - + 80
Mounting position			As required
Terminal capacities	mm ²		
Solid	mm ²		2 x 0.5 - 1.5_x
Flexible with ferrule	mm ²		2 x 0.5 - 1.5_x
Tightening torque for terminal screw	Nm		0.8

Contacts

Rated impulse withstand voltage	U _{imp}	V AC	4000
Rated insulation voltage	U _i	V	250
Rated conditional short-circuit current	I _q	kA	1
Overvoltage category/pollution degree			III/3
Max. short-circuit protective device			
Fuse	gG/gL	A	10

Design verification as per IEC/EN 61439

Technical data for design verification			
Operating ambient temperature min.		°C	-25
Operating ambient temperature max.		°C	70

Technical data ETIM 7.0

Low-voltage industrial components (EG000017) / Push button, complete (EC001028)			
Electric engineering, automation, process control engineering / Low-voltage switch technology / Command and alarm device / Push-button actuator, complete unit (ecl@ss10.0.1-27-37-12-28 [AKF046014])			
Number of command positions			1
Type of button			Flat
Colour button			Red
Construction type lens			Round
Hole diameter		mm	22.5
Width opening		mm	0
Height opening		mm	0
Suitable for illumination			No
Switching function latching			No
Spring-return			Yes
Supply voltage lamp		V	0
Number of contacts as normally open contact			0
Number of contacts as normally closed contact			2
Number of contacts as change-over contact			0
Type of electric connection			Screw connection
With front ring			Yes
Material front ring			Plastic
Colour front ring			Other
Degree of protection (IP)			Other
Degree of protection (NEMA)			

Approvals

Product Standards			IEC/EN 60947-5-1; UL 508; CAN/CSA-C22.2 No. 14-05 und 94-M91; CE marking
-------------------	--	--	--

UL File No.		E29184
UL Category Control No.		NKCR
CSA File No.		165628
CSA Class No.		321103
North America Certification		UL listed, CSA certified
Degree of Protection		1,3R,4X,12,13

Dimensions

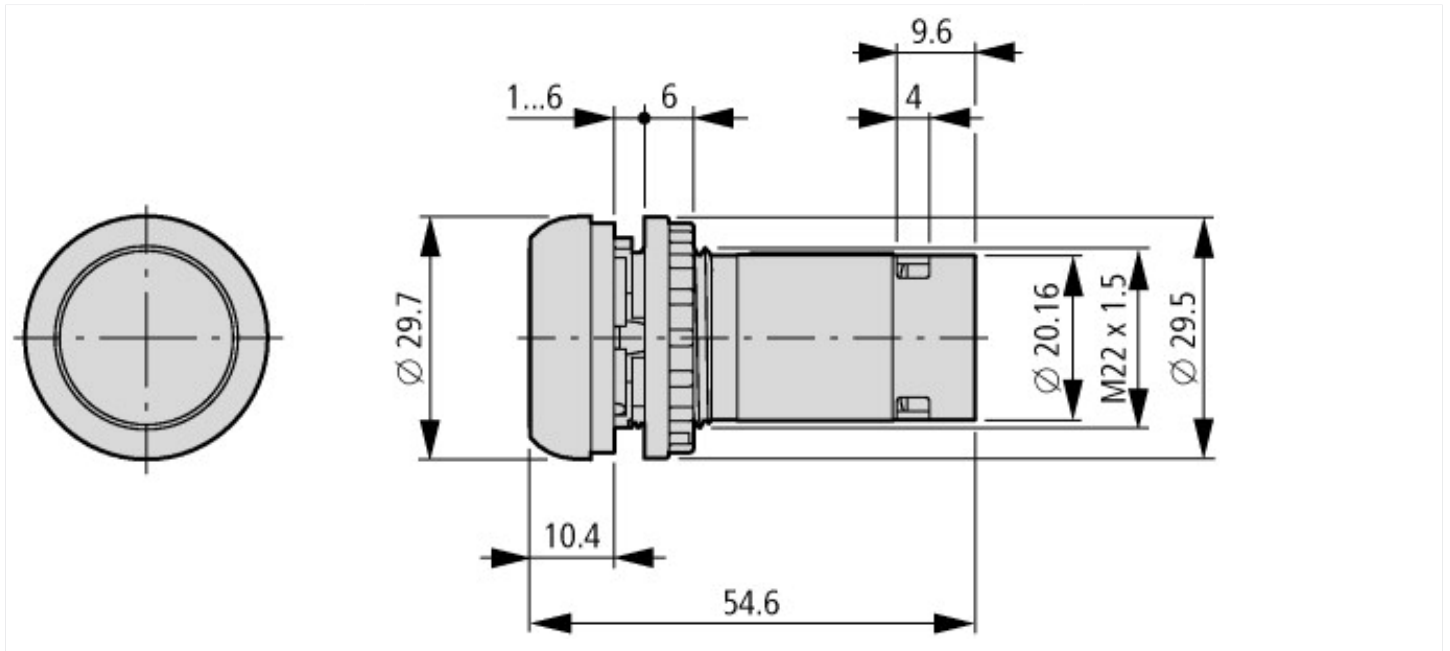

Additional product information (links)

IL04716025Z RMQ-Titan: compact programm

IL04716025Z RMQ-Titan: compact programm https://es-assets.eaton.com/DOCUMENTATION/AWA_INSTRUCTIONS/IL04716025Z2019_05.pdf