



NZM3 PXR20 circuit breaker, 630A, 3p, withdrawable unit

Part no. **NZMH3-VX630-AVE**  
 Catalog No. **191550**

Similar to illustration

### Delivery program

Product range			Circuit-breaker
Protective function			Systems, cable, selectivity and generator protection
Standard/Approval			IEC
Installation type			Withdrawable
Release system			Electronic release
Construction size			NZM3
Description			LSI overload protection and delayed and non-delayed short-circuit protective device R.m.s. value measurement and "thermal memory" USB interface for configuration and test function with Power Xpert Protection Manager software Optionally communication-capable with interface module and internal Modbus RTU module or CAM
Number of poles			3 pole
Standard equipment			Screw connection





### Switching capacity

400/415 V 50 Hz	$I_{cu}$	kA	150
-----------------	----------	----	-----

### Rated current = rated uninterrupted current

Rated current = rated uninterrupted current	$I_n = I_u$	A	630
---	-------------	---	-----

### Setting range

Overload trip			
	$I_r$	A	252 - 630
Short-circuit releases			
			
Non-delayed	$I_i = I_n \times \dots$		2 - 8
			
Delayed	$I_{sd} = I_r \times \dots$		1.5 - 7
			

### Technical data

#### General

Standards			IEC/EN 60947
Protection against direct contact			Finger and back of hand proof to VDE 0106 Part 100
Climatic proofing			Damp heat, constant, to IEC 60068-2-78 Damp heat, cyclic, to IEC 60068-2-30
Ambient temperature			
Ambient temperature, storage		°C	- 40 - + 70
Operation		°C	-25 - +70
Mechanical shock resistance (10 ms half-sinusoidal shock) according to IEC 60068-2-27		g	20 (half-sinusoidal shock 20 ms)
Safe isolation to EN 61140			
Between auxiliary contacts and main contacts		V AC	500

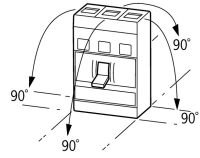
between the auxiliary contacts	V AC	300
Weight	kg	6.34
Mounting position	Vertical and 90° in all directions	 <p>With XFI earth-fault release:  - NZM1, N1, NZM2, N2: vertical and 90° in all directions  with plug-in unit  - NZM1, N1, NZM2, N2: vertical, 90° right/left  with withdrawable unit:  - NZM3, N3: vertical, 90° right/left  - NZM4, N4: vertical  with remote operator:  - NZM2, N(S)2, NZM3, N(S)3, NZM4, N(S)4: vertical and 90° in all directions</p>
Direction of incoming supply		as required
Degree of protection		
Device		In the operating controls area: IP20 (basic degree of protection)
Enclosures		With insulating surround: IP40 With door coupling rotary handle: IP66
Terminations		Tunnel terminal: IP10 Phase isolator and strip terminal: IP00
Other technical data (sheet catalogue)		Weight Temperature dependency, Derating Effective power loss

### Circuit-breakers

Rated current = rated uninterrupted current	$I_n = I_u$	A	630
Rated surge voltage invariability	$U_{imp}$		
Main contacts		V	8000
Auxiliary contacts		V	6000
Rated operational voltage	$U_e$	V AC	690
Overvoltage category/pollution degree			III/3
Rated insulation voltage	$U_i$	V	690
Use in unearthed supply systems		V	≤ 690

### Switching capacity

Rated short-circuit making capacity	$I_{cm}$		
240 V	$I_{cm}$	kA	330
400/415 V	$I_{cm}$	kA	330
440 V 50/60 Hz	$I_{cm}$	kA	286
525 V 50/60 Hz	$I_{cm}$	kA	143
690 V 50/60 H	$I_c$	kA	70
Rated short-circuit breaking capacity $I_{cn}$	$I_{cn}$		
$I_{cu}$ to IEC/EN 60947 test cycle O-t-CO	$I_{cu}$	kA	
240 V 50/60 Hz	$I_{cu}$	kA	150
400/415 V 50/60 Hz	$I_{cu}$	kA	150
440 V 50/60 Hz	$I_{cu}$	kA	130
525 V 50/60 Hz	$I_{cu}$	kA	65
690 V 50/60 Hz	$I_{cu}$	kA	35
$I_{cs}$ to IEC/EN 60947 test cycle O-t-CO-t-CO	$I_{cs}$	kA	
240 V 50/60 Hz	$I_{cs}$	kA	150
400/415 V 50/60 Hz	$I_{cs}$	kA	150
440 V 50/60 Hz	$I_{cs}$	kA	130
525 V 50/60 Hz	$I_{cs}$	kA	33
690 V 50/60 Hz	$I_{cs}$	kA	9
Rated short-time withstand current			Maximum back-up fuse, if the expected short-circuit currents at the installation location exceed the switching capacity of the circuit-breaker.
t = 0.3 s	$I_{cw}$	kA	3.3
t = 1 s	$I_{cw}$	kA	3.3
Utilization category to IEC/EN 60947-2			A

Lifespan, mechanical(of which max. 50 % trip by shunt/undervoltage release)	Operations		15000
Lifespan, electrical			
AC-1			
400 V 50/60 Hz	Operations		5000
415 V 50/60 Hz	Operations		5000
690 V 50/60 Hz	Operations		3000
Max. operating frequency		Ops/h	60
Total break time at short-circuit		ms	< 10

### Terminal capacity

Standard equipment			Screw connection
Accessories required			NZM3-XAVS
Optional accessories			Box terminal Tunnel terminal connection on rear
Round copper conductor			
Box terminal			
Solid		mm <sup>2</sup>	2 x 16
Stranded		mm <sup>2</sup>	1 x (35 - 240) 2 x (25-120)
Tunnel terminal			
Solid		mm <sup>2</sup>	1 x 16
Stranded			
1-hole		mm <sup>2</sup>	1 x (16 - 185)
Bolt terminal and rear-side connection			
Direct on the switch			
Solid		mm <sup>2</sup>	1 x 16 2 x 16
Stranded		mm <sup>2</sup>	1 x (25 - 240) 2 x (25 - 240)
Connection width extension		mm <sup>2</sup>	
Connection width extension		mm <sup>2</sup>	2 x 300
Al circular conductor			
Tunnel terminal			
Solid		mm <sup>2</sup>	1 x 16
Stranded			
Stranded		mm <sup>2</sup>	1 x (25 - 185) <sup>2)</sup>
Double hole		mm <sup>2</sup>	1 x (50 - 240) 2 x (50 - 240)
			<sup>2)</sup> Up to 240 mm <sup>2</sup> can be connected depending on the cable manufacturer.
Cu strip (number of segments x width x segment thickness)			
Box terminal			
	min.	mm	6 x 16 x 0.8
	max.	mm	10 x 24 x 1.0 + 5 x 24 x 1.0 (2 x) 8 x 24 x 1.0
Bolt terminal and rear-side connection			
Flat copper strip, with holes	min.	mm	6 x 16 x 0.8
Flat copper strip, with holes	max.	mm	10 x 32 x 1.0 + 5 x 32 x 1.0
Connection width extension		mm	(2 x) 10 x 50 x 1.0
Copper busbar (width x thickness)		mm	
Bolt terminal and rear-side connection			
Screw connection			M10
Direct on the switch			
	min.	mm	20 x 5
	max.	mm	30 x 10 + 30 x 5
Connection width extension		mm	
Connection width extension	max.	mm	2 x (10 x 50)

Control cables			
	mm <sup>2</sup>	1 x (0.75 - 2.5) 2 x (0.75 - 1.5)	

## Design verification as per IEC/EN 61439

Technical data for design verification			
Rated operational current for specified heat dissipation	I <sub>n</sub>	A	630
Equipment heat dissipation, current-dependent	P <sub>vid</sub>	W	119.07
Operating ambient temperature min.		°C	-25
Operating ambient temperature max.		°C	70
IEC/EN 61439 design verification			
10.2 Strength of materials and parts			
10.2.2 Corrosion resistance			
10.2.3.1 Verification of thermal stability of enclosures			Meets the product standard's requirements.
10.2.3.2 Verification of resistance of insulating materials to normal heat			Meets the product standard's requirements.
10.2.3.3 Verification of resistance of insulating materials to abnormal heat and fire due to internal electric effects			Meets the product standard's requirements.
10.2.4 Resistance to ultra-violet (UV) radiation			Meets the product standard's requirements.
10.2.5 Lifting			Does not apply, since the entire switchgear needs to be evaluated.
10.2.6 Mechanical impact			Does not apply, since the entire switchgear needs to be evaluated.
10.2.7 Inscriptions			Meets the product standard's requirements.
10.3 Degree of protection of ASSEMBLIES			Does not apply, since the entire switchgear needs to be evaluated.
10.4 Clearances and creepage distances			Meets the product standard's requirements.
10.5 Protection against electric shock			Does not apply, since the entire switchgear needs to be evaluated.
10.6 Incorporation of switching devices and components			Does not apply, since the entire switchgear needs to be evaluated.
10.7 Internal electrical circuits and connections			Is the panel builder's responsibility.
10.8 Connections for external conductors			Is the panel builder's responsibility.
10.9 Insulation properties			
10.9.2 Power-frequency electric strength			Is the panel builder's responsibility.
10.9.3 Impulse withstand voltage			Is the panel builder's responsibility.
10.9.4 Testing of enclosures made of insulating material			Is the panel builder's responsibility.
10.10 Temperature rise			The panel builder is responsible for the temperature rise calculation. Eaton will provide heat dissipation data for the devices.
10.11 Short-circuit rating			Is the panel builder's responsibility. The specifications for the switchgear must be observed.
10.12 Electromagnetic compatibility			Is the panel builder's responsibility. The specifications for the switchgear must be observed.
10.13 Mechanical function			The device meets the requirements, provided the information in the instruction leaflet (IL) is observed.

## Technical data ETIM 7.0

Low-voltage industrial components (EG000017) / Power circuit-breaker for trafo/generator/installation protection (EC000228)			
Electric engineering, automation, process control engineering / Low-voltage switch technology / Circuit breaker (LV < 1 kV) / Circuit breaker for power transformer, generator and system protection (ecl@ss10.0.1-27-37-04-09 [AJZ716013])			
Rated permanent current I <sub>u</sub>		A	630
Rated voltage		V	690 - 690
Rated short-circuit breaking capacity I <sub>cu</sub> at 400 V, 50 Hz		kA	150
Overload release current setting		A	252 - 630
Adjustment range short-term delayed short-circuit release		A	1.5 - 7
Adjustment range undelayed short-circuit release		A	2 - 8
Integrated earth fault protection			No
Type of electrical connection of main circuit			Other
Device construction			Built-in device slide-in technique (withdrawable)
Suitable for DIN rail (top hat rail) mounting			No
DIN rail (top hat rail) mounting optional			No
Number of auxiliary contacts as normally closed contact			0
Number of auxiliary contacts as normally open contact			0
Number of auxiliary contacts as change-over contact			0

With switched-off indicator		No
With under voltage release		No
Number of poles		3
Position of connection for main current circuit		Front side
Type of control element		Rocker lever
Complete device with protection unit		Yes
Motor drive integrated		No
Motor drive optional		Yes
Degree of protection (IP)		IP20

## Characteristics

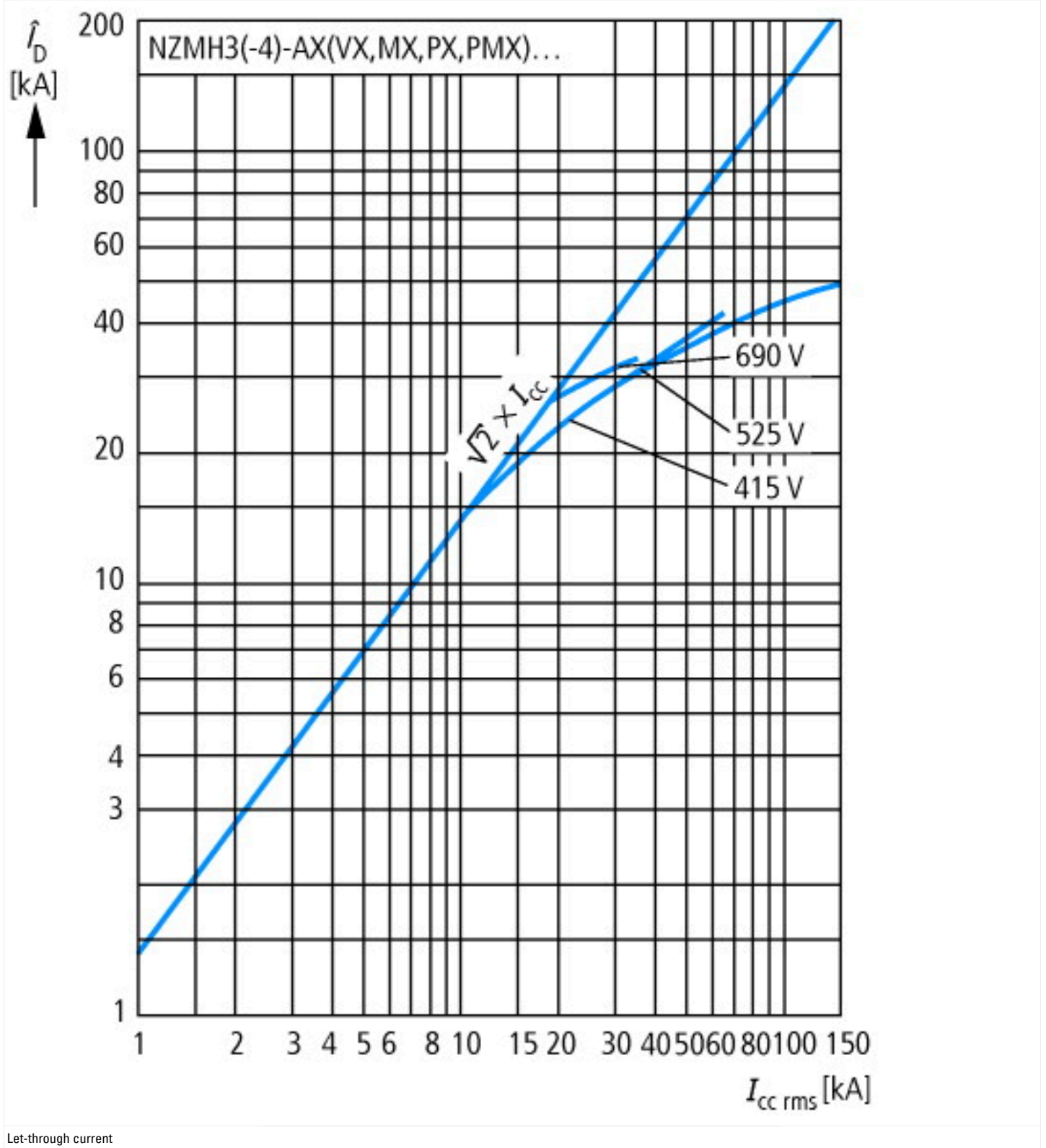

Let-through current

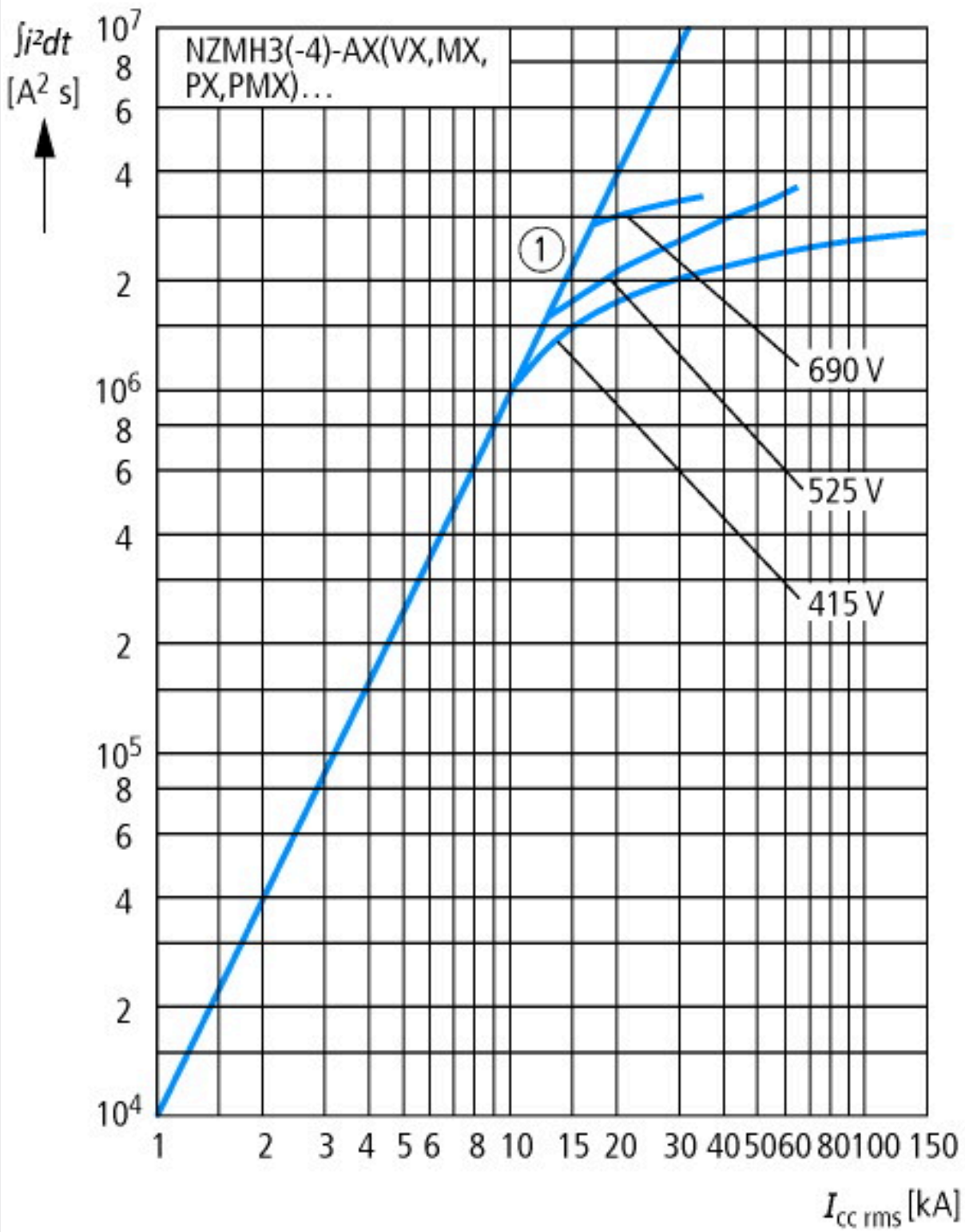

Let-through energy

# Dimensions

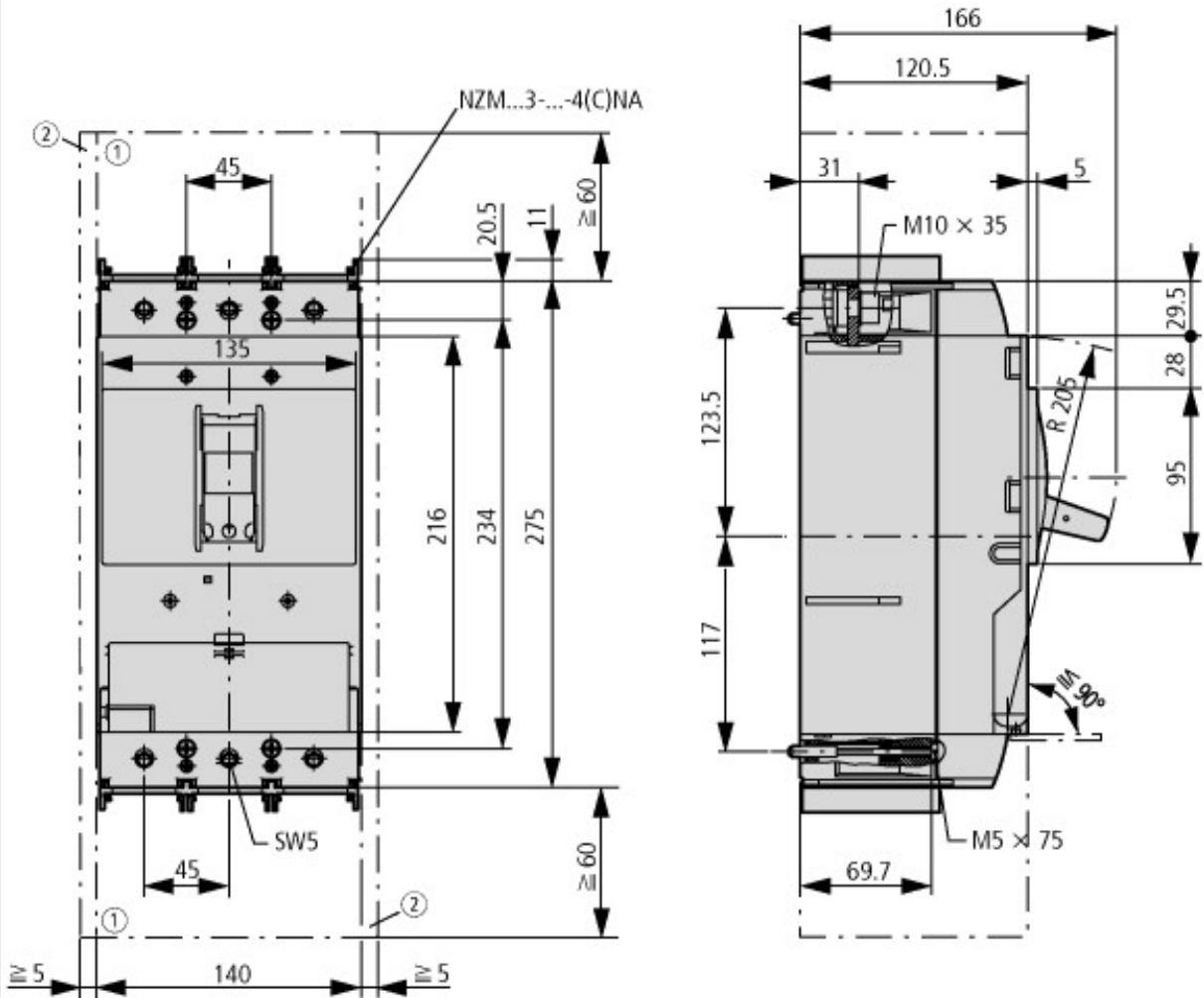

- ① Blow out area, minimum clearance to adjacent parts
- ② Minimum clearance to adjacent parts



### Additional product information (links)

#### IL012100ZU NZM3-PXR circuit-breaker, basic device , NZM3-PXR Circuit-Breaker, basic unit

IL012100ZU NZM3-PXR circuit-breaker, basic device , NZM3-PXR Circuit-Breaker, basic unit	<a href="https://es-assets.eaton.com/DOCUMENTATION/AWA_INSTRUCTIONS/IL012100ZU2020_10.pdf">https://es-assets.eaton.com/DOCUMENTATION/AWA_INSTRUCTIONS/IL012100ZU2020_10.pdf</a>
Weight	<a href="http://ecat.moeller.net/flip-cat/?edition=HPLEN&amp;startpage=17.171">http://ecat.moeller.net/flip-cat/?edition=HPLEN&amp;startpage=17.171</a>
Temperature dependency, Derating	<a href="http://ecat.moeller.net/flip-cat/?edition=HPLEN&amp;startpage=17.172">http://ecat.moeller.net/flip-cat/?edition=HPLEN&amp;startpage=17.172</a>
Effective power loss	<a href="http://ecat.moeller.net/flip-cat/?edition=HPLEN&amp;startpage=17.174">http://ecat.moeller.net/flip-cat/?edition=HPLEN&amp;startpage=17.174</a>
additional technical information for NZM power switch	<a href="https://es-assets.eaton.com/DOCUMENTATION/PDF/nzm_technic_de_en.pdf">https://es-assets.eaton.com/DOCUMENTATION/PDF/nzm_technic_de_en.pdf</a>