



NZM2 PXR20 circuit breaker, 90A, 3p, plug-in technology

Part no. **NZMS2-MX90-SVE**
 Catalog No. **191656**

Similar to illustration

Delivery program

Product range				Circuit-breaker
Protective function				Motor protection
Standard/Approval				IEC
Installation type				Plug-in units
Release system				Electronic release
Construction size				NZM2
Description				IEC/EN 60947-2 with characteristic conforming to IEC/EN 60947-4-1 with phase failure sensitivity The circuit-breaker fulfills all requirements for AC-3 switching category. R.m.s. value measurement and "thermal memory" Adjustable time delay setting to overcome current peaks t_r at $6 \times I_r$ also infinity (without overload releases) All AC-3 rating data applies to direct switching by the circuit-breaker under normal operating conditions. If, for example, a contactor takes over AC-3 switching under normal operating conditions, the full rated uninterrupted current applies to the circuit-breaker, $I_n = I_u$.
Number of poles				3 pole
Standard equipment				Screw connection
Switching capacity				
400/415 V 50 Hz	I_{cu}	kA		70
Rated current = rated uninterrupted current	$I_n = I_u$	A		90
Setting range				
Overload trip				
	I_r	A		36 - 90
Short-circuit releases				
Non-delayed	$I_i = I_n \times \dots$			2 - 18
Motor rating AC-3 50/60 Hz				
380 V 400 V	P	kW		45
660 V 690 V	P	kW		75
Motor rating AC-3 50/60 Hz				
400 V	P	kW		45
660 V 690 V	P	kW		75
Rated operational current AC-3 50/60 Hz				
400 V	I_e	A		81

Technical data

General			
Standards			IEC/EN 60947

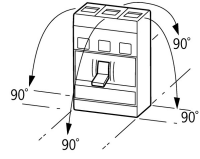
Protection against direct contact			Finger and back of hand proof to VDE 0106 Part 100
Climatic proofing			Damp heat, constant, to IEC 60068-2-78 Damp heat, cyclic, to IEC 60068-2-30
Ambient temperature			
Ambient temperature, storage	°C		- 40 - + 70
Operation	°C		-25 - +70
Mechanical shock resistance (10 ms half-sinusoidal shock) according to IEC 60068-2-27	g		20 (half-sinusoidal shock 20 ms)
Safe isolation to EN 61140			
Between auxiliary contacts and main contacts	V AC		500
between the auxiliary contacts	V AC		300
Mounting position			Vertical and 90° in all directions  With XFI earth-fault release: - NZM1, N1, NZM2, N2: vertical and 90° in all directions with plug-in unit - NZM1, N1, NZM2, N2: vertical, 90° right/left with withdrawable unit: - NZM3, N3: vertical, 90° right/left - NZM4, N4: vertical with remote operator: - NZM2, N(S)2, NZM3, N(S)3, NZM4, N(S)4: vertical and 90° in all directions
Direction of incoming supply			as required
Degree of protection			
Device			In the operating controls area: IP20 (basic degree of protection)
Enclosures			With insulating surround: IP40 With door coupling rotary handle: IP66
Terminations			Tunnel terminal: IP10 Phase isolator and strip terminal: IP00
Other technical data (sheet catalogue)			Temperature dependency, Derating

Circuit-breakers

Rated current = rated uninterrupted current	$I_n = I_u$	A	90
Rated surge voltage invariability	U_{imp}		
Main contacts		V	8000
Auxiliary contacts		V	6000
Rated operational voltage	U_e	V AC	690
Overvoltage category/pollution degree			III/3
Rated insulation voltage	U_i	V	690
Use in unearthed supply systems		V	≤ 690

Switching capacity

Rated short-circuit making capacity	I_{cm}		
240 V	I_{cm}	kA	220
400/415 V	I_{cm}	kA	154
440 V 50/60 Hz	I_{cm}	kA	143
525 V 50/60 Hz	I_{cm}	kA	80
690 V 50/60 H	I_c	kA	40
Rated short-circuit breaking capacity I_{cn}	I_{cn}		
I_{cu} to IEC/EN 60947 test cycle O-t-CO	I_{cu}	kA	
240 V 50/60 Hz	I_{cu}	kA	100
400/415 V 50/60 Hz	I_{cu}	kA	70
440 V 50/60 Hz	I_{cu}	kA	65
525 V 50/60 Hz	I_{cu}	kA	36
690 V 50/60 Hz	I_{cu}	kA	20
I_{cs} to IEC/EN 60947 test cycle O-t-CO-t-CO	I_{cs}	kA	
240 V 50/60 Hz	I_{cs}	kA	100
400/415 V 50/60 Hz	I_{cs}	kA	70
440 V 50/60 Hz	I_{cs}	kA	65
525 V 50/60 Hz	I_{cs}	kA	36

690 V 50/60 Hz	I _{cs}	kA	6
			Maximum back-up fuse, if the expected short-circuit currents at the installation location exceed the switching capacity of the circuit-breaker.
Rated short-time withstand current			
t = 0.3 s	I _{cw}	kA	1.9
t = 1 s	I _{cw}	kA	1.9
Utilization category to IEC/EN 60947-2			A
Lifespan, mechanical(of which max. 50 % trip by shunt/undervoltage release)	Operations		20000
Lifespan, electrical			
AC-1			
400 V 50/60 Hz	Operations		10000
415 V 50/60 Hz	Operations		10000
690 V 50/60 Hz	Operations		7500
AC--3			
400 V 50/60 Hz	Operations		6500
415 V 50/60 Hz	Operations		6500
690 V 50/60 Hz	Operations		5000
Max. operating frequency		Ops/h	120
Total break time at short-circuit		ms	< 10

Terminal capacity

Standard equipment			Screw connection
Accessories required			NZM2-XSVS
Optional accessories			Box terminal Tunnel terminal connection on rear
Round copper conductor			
Box terminal			
Solid		mm ²	1 x (10 - 16) 2 x (6 - 16)
Stranded		mm ²	1 x (25 - 185) 2 x (25 - 70)
Tunnel terminal			
Solid		mm ²	1 x 16
Stranded			
1-hole		mm ²	1 x (25 - 185)
Bolt terminal and rear-side connection			
Direct on the switch			
Solid		mm ²	1 x (10 - 16) 2 x (6 - 16)
Stranded		mm ²	1 x (25 - 185) 2 x (25 - 70)
Al circular conductor			
Tunnel terminal			
Solid		mm ²	1 x 16
Stranded			
Stranded		mm ²	1 x (25 - 185)
Cu strip (number of segments x width x segment thickness)			
Box terminal			
	min.	mm	2 x 9 x 0.8
	max.	mm	10 x 16 x 0.8 (2x) 8 x 15.5 x 0,8
Bolt terminal and rear-side connection			
Flat copper strip, with holes	min.	mm	2 x 16 x 0.8
Flat copper strip, with holes	max.	mm	10 x 24 x 0.8
Copper busbar (width x thickness)			
Bolt terminal and rear-side connection			
Screw connection			M8
Direct on the switch			

	min.	mm	16 x 5
	max.	mm	24 x 8
Control cables		mm ²	1 x (0.75 - 2.5) 2 x (0.75 - 1.5)

Design verification as per IEC/EN 61439

Technical data for design verification			
Rated operational current for specified heat dissipation	I _n	A	90
Equipment heat dissipation, current-dependent	P _{vid}	W	6.6825
Operating ambient temperature min.		°C	-25
Operating ambient temperature max.		°C	70
IEC/EN 61439 design verification			
10.2 Strength of materials and parts			
10.2.2 Corrosion resistance			Meets the product standard's requirements.
10.2.3.1 Verification of thermal stability of enclosures			Meets the product standard's requirements.
10.2.3.2 Verification of resistance of insulating materials to normal heat			Meets the product standard's requirements.
10.2.3.3 Verification of resistance of insulating materials to abnormal heat and fire due to internal electric effects			Meets the product standard's requirements.
10.2.4 Resistance to ultra-violet (UV) radiation			Meets the product standard's requirements.
10.2.5 Lifting			Does not apply, since the entire switchgear needs to be evaluated.
10.2.6 Mechanical impact			Does not apply, since the entire switchgear needs to be evaluated.
10.2.7 Inscriptions			Meets the product standard's requirements.
10.3 Degree of protection of ASSEMBLIES			Does not apply, since the entire switchgear needs to be evaluated.
10.4 Clearances and creepage distances			Meets the product standard's requirements.
10.5 Protection against electric shock			Does not apply, since the entire switchgear needs to be evaluated.
10.6 Incorporation of switching devices and components			Does not apply, since the entire switchgear needs to be evaluated.
10.7 Internal electrical circuits and connections			Is the panel builder's responsibility.
10.8 Connections for external conductors			Is the panel builder's responsibility.
10.9 Insulation properties			
10.9.2 Power-frequency electric strength			Is the panel builder's responsibility.
10.9.3 Impulse withstand voltage			Is the panel builder's responsibility.
10.9.4 Testing of enclosures made of insulating material			Is the panel builder's responsibility.
10.10 Temperature rise			The panel builder is responsible for the temperature rise calculation. Eaton will provide heat dissipation data for the devices.
10.11 Short-circuit rating			Is the panel builder's responsibility. The specifications for the switchgear must be observed.
10.12 Electromagnetic compatibility			Is the panel builder's responsibility. The specifications for the switchgear must be observed.
10.13 Mechanical function			The device meets the requirements, provided the information in the instruction leaflet (IL) is observed.

Technical data ETIM 7.0

Low-voltage industrial components (EG000017) / Motor protection circuit-breaker (EC000074)			
Electric engineering, automation, process control engineering / Low-voltage switch technology / Circuit breaker (LV < 1 kV) / Motor protection circuit-breaker (ecl@ss10.0.1-27-37-04-01 [AGZ529016])			
Overload release current setting		A	36 - 90
Adjustment range undelayed short-circuit release		A	2 - 18
With thermal protection			Yes
Phase failure sensitive			Yes
Switch off technique			Electronic
Rated operating voltage		V	690 - 690
Rated permanent current I _u		A	90
Rated operation power at AC-3, 230 V		kW	22
Rated operation power at AC-3, 400 V		kW	45
Type of electrical connection of main circuit			Other
Type of control element			Rocker lever
Device construction			Built-in device plug-in technique

With integrated auxiliary switch		No
With integrated under voltage release		No
Number of poles		3
Rated short-circuit breaking capacity I_{cu} at 400 V, AC	kA	70
Degree of protection (IP)		IP20
Height	mm	184
Width	mm	105
Depth	mm	149

Characteristics

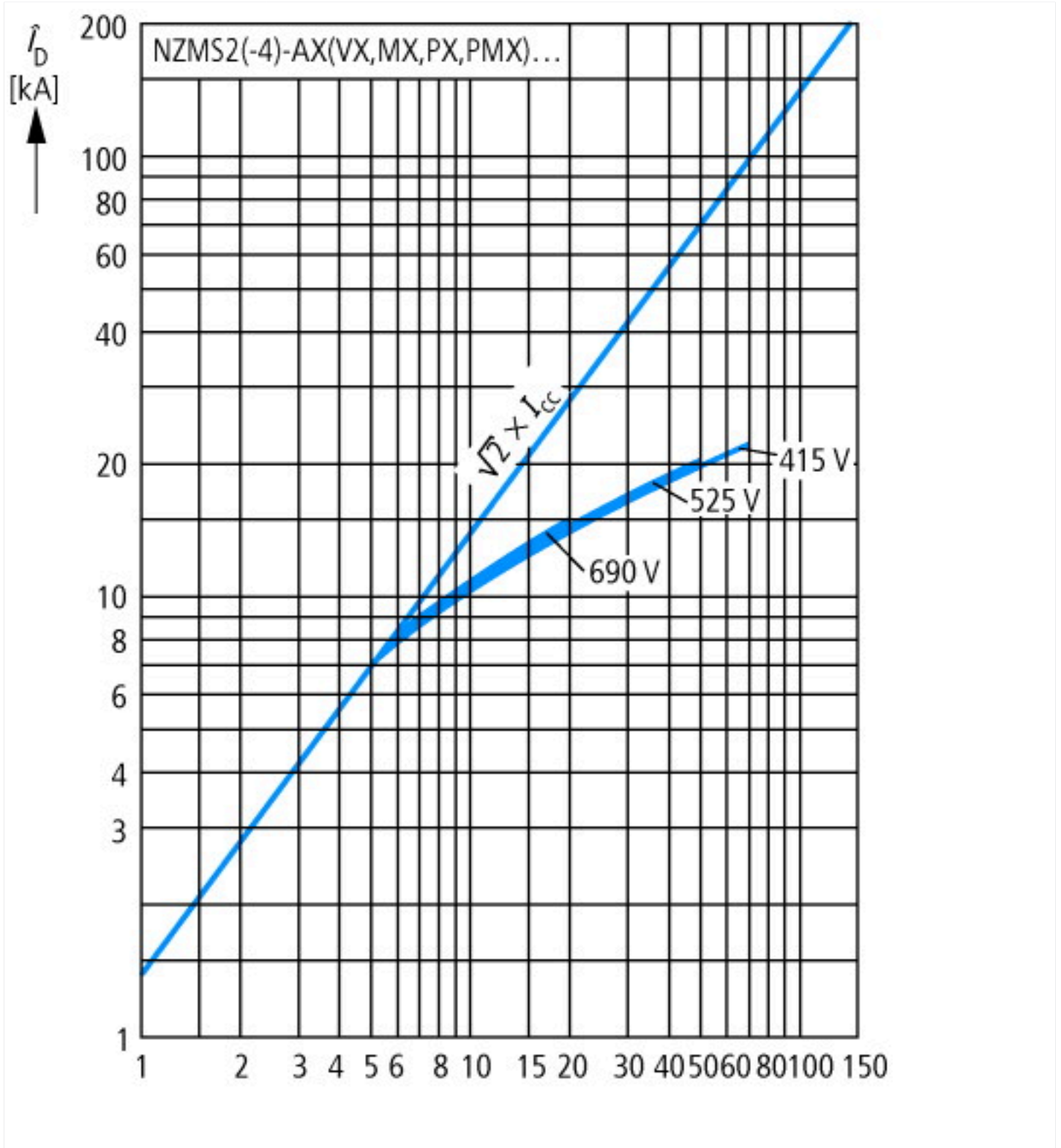

Let-through current

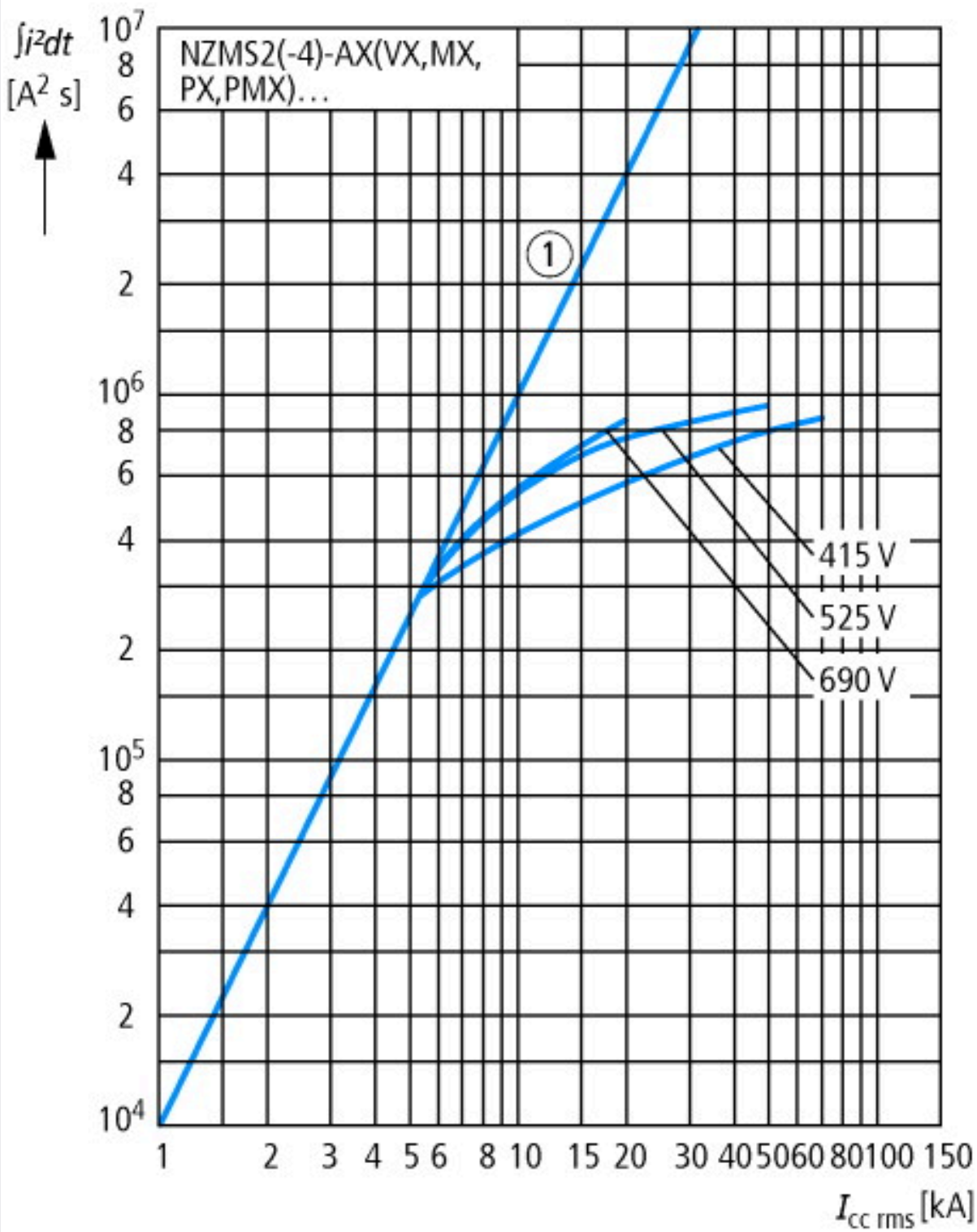

Let-through energy

Dimensions

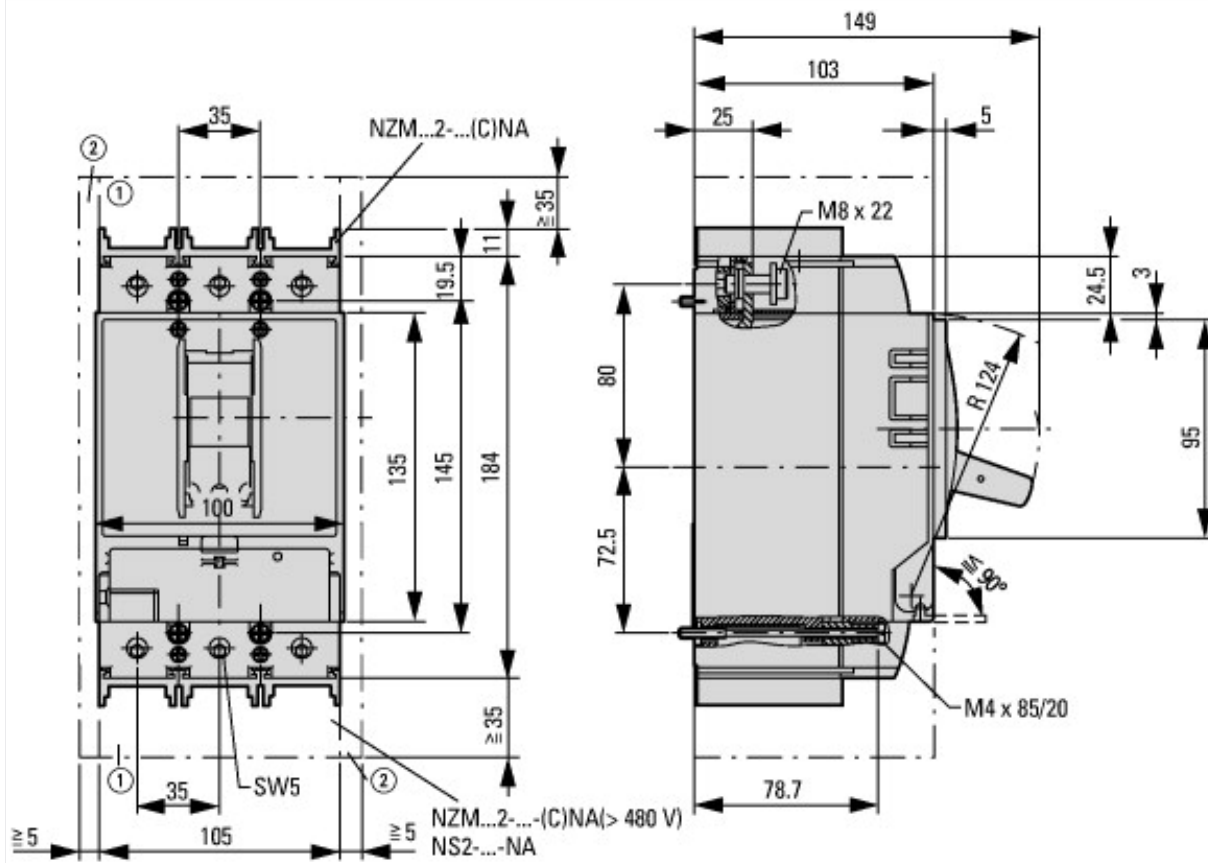

- ① Blow out area, minimum clearance to adjacent parts
- ② Minimum clearance to adjacent parts





Additional product information (links)

IL012099ZU NZM2-PXR circuit-breaker, basic device, NZM2-PXR Circuit-Breaker, basic unit

IL012099ZU NZM2-PXR circuit-breaker, basic device, NZM2-PXR Circuit-Breaker, basic unit https://es-assets.eaton.com/DOCUMENTATION/AWA_INSTRUCTIONS/IL012099ZU2019_03.pdf

Temperature dependency, Derating <http://ecat.moeller.net/flip-cat/?edition=HPLEN&startpage=17.172>

additional technical information for NZM power switch https://es-assets.eaton.com/DOCUMENTATION/PDF/nzm_technik_de_en.pdf