





NZM2 PXR10 circuit breaker, 3 pole, 250A, screw terminal

Part no. **NZMS2-AX250**
 Catalog No. **192032**

Similar to illustration

Delivery program

| | | | | |
|---|--------------------------|----|--|---|
| Product range | | | | Circuit-breaker |
| Protective function | | | | System and cable protection |
| Standard/Approval | | | | IEC |
| Installation type | | | | Fixed |
| Release system | | | | Electronic release |
| Construction size | | | | NZM2 |
| Description | | | | Overload and short-circuit protection LI R.m.s. value measurement and "thermal memory" USB interface for configuration and test function with Power Xpert Protection Manager software |
| Number of poles | | | | 3 pole |
| Standard equipment | | | | Screw connection |
| Switching capacity | | | | |
| 400/415 V 50 Hz | I_{cu} | kA | | 70 |
| Rated current = rated uninterrupted current | | | | |
| Rated current = rated uninterrupted current | $I_n = I_u$ | A | | 250 |
| Setting range | | | | |
| Overload trip | | | | |
|  | I_r | A | | 100 - 250 |
| Short-circuit releases | | | | |
|  | | | | |
| Non-delayed | $I_i = I_n \times \dots$ | | | 2 - 12 |
|  | | | | |

Technical data

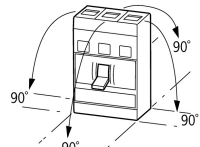
| | | | | |
|---|--|------|--|---|
| General | | | | |
| Standards | | | | IEC/EN 60947 |
| Protection against direct contact | | | | Finger and back of hand proof to VDE 0106 Part 100 |
| Climatic proofing | | | | Damp heat, constant, to IEC 60068-2-78 Damp heat, cyclic, to IEC 60068-2-30 |
| Ambient temperature | | | | |
| Ambient temperature, storage | | °C | | - 40 - + 70 |
| Operation | | °C | | -25 - +70 |
| Mechanical shock resistance (10 ms half-sinusoidal shock) according to IEC 60068-2-27 | | g | | 20 (half-sinusoidal shock 20 ms) |
| Safe isolation to EN 61140 | | | | |
| Between auxiliary contacts and main contacts | | V AC | | 500 |
| between the auxiliary contacts | | V AC | | 300 |
| Mounting position | | | | Vertical and 90° in all directions |
| | | | |  <p>With XFI earth-fault release: - NZM1, N1, NZM2, N2: vertical and 90° in all directions with plug-in unit - NZM1, N1, NZM2, N2: vertical, 90° right/left with withdrawable unit:</p> |

- NZM3, N3: vertical, 90° right/left
- NZM4, N4: vertical with remote operator:
- NZM2, N(S)2, NZM3, N(S)3, NZM4, N(S)4: vertical and 90° in all directions

| | | |
|--|--|--|
| Direction of incoming supply | | as required |
| Degree of protection | | |
| Device | | In the operating controls area: IP20 (basic degree of protection) |
| Enclosures | | With insulating surround: IP40 With door coupling rotary handle: IP66 |
| Terminations | | Tunnel terminal: IP10 Phase isolator and strip terminal: IP00 |
| Other technical data (sheet catalogue) | | Temperature dependency, Derating |

Circuit-breakers

| | | | |
|---|-------------|------|-------|
| Rated current = rated uninterrupted current | $I_n = I_u$ | A | 250 |
| Rated surge voltage invariability | U_{imp} | | |
| Main contacts | | V | 8000 |
| Auxiliary contacts | | V | 6000 |
| Rated operational voltage | U_e | V AC | 690 |
| Overvoltage category/pollution degree | | | III/3 |
| Rated insulation voltage | U_i | V | 690 |
| Use in unearthed supply systems | | V | ≤ 690 |

Switching capacity

| | | | |
|--|------------|-------|---|
| Rated short-circuit making capacity | I_{cm} | | |
| 240 V | I_{cm} | kA | 220 |
| 400/415 V | I_{cm} | kA | 154 |
| 440 V 50/60 Hz | I_{cm} | kA | 143 |
| 525 V 50/60 Hz | I_{cm} | kA | 80 |
| 690 V 50/60 Hz | I_c | kA | 40 |
| Rated short-circuit breaking capacity I_{cn} | I_{cn} | | |
| I_{cu} to IEC/EN 60947 test cycle O-t-CO | I_{cu} | kA | |
| 240 V 50/60 Hz | I_{cu} | kA | 100 |
| 400/415 V 50/60 Hz | I_{cu} | kA | 70 |
| 440 V 50/60 Hz | I_{cu} | kA | 65 |
| 525 V 50/60 Hz | I_{cu} | kA | 36 |
| 690 V 50/60 Hz | I_{cu} | kA | 20 |
| I_{cs} to IEC/EN 60947 test cycle O-t-CO-t-CO | I_{cs} | kA | |
| 240 V 50/60 Hz | I_{cs} | kA | 100 |
| 400/415 V 50/60 Hz | I_{cs} | kA | 70 |
| 440 V 50/60 Hz | I_{cs} | kA | 65 |
| 525 V 50/60 Hz | I_{cs} | kA | 36 |
| 690 V 50/60 Hz | I_{cs} | kA | 6 |
| | | | Maximum back-up fuse, if the expected short-circuit currents at the installation location exceed the switching capacity of the circuit-breaker. |
| Rated short-time withstand current | | | |
| $t = 0.3$ s | I_{cw} | kA | 1.9 |
| $t = 1$ s | I_{cw} | kA | 1.9 |
| Utilization category to IEC/EN 60947-2 | | | A |
| Lifespan, mechanical (of which max. 50 % trip by shunt/undervoltage release) | Operations | | 20000 |
| Lifespan, electrical | | | |
| AC-1 | | | |
| 400 V 50/60 Hz | Operations | | 10000 |
| 415 V 50/60 Hz | Operations | | 10000 |
| 690 V 50/60 Hz | Operations | | 7500 |
| Max. operating frequency | | Ops/h | 120 |
| Total break time at short-circuit | | ms | < 10 |

Terminal capacity

| | | | |
|---|------|-----------------|---|
| Standard equipment | | | Screw connection |
| Optional accessories | | | Box terminal Tunnel terminal connection on rear |
| Round copper conductor | | | |
| Box terminal | | | |
| Solid | | mm ² | 1 x (10 - 16) 2 x (6 - 16) |
| Stranded | | mm ² | 1 x (25 - 185) 2 x (25 - 70) |
| Tunnel terminal | | | |
| Solid | | mm ² | 1 x 16 |
| Stranded | | | |
| 1-hole | | mm ² | 1 x (25 - 185) |
| Bolt terminal and rear-side connection | | | |
| Direct on the switch | | | |
| Solid | | mm ² | 1 x (10 - 16) 2 x (6 - 16) |
| Stranded | | mm ² | 1 x (25 - 185) 2 x (25 - 70) |
| Al circular conductor | | | |
| Tunnel terminal | | | |
| Solid | | mm ² | 1 x 16 |
| Stranded | | | |
| Stranded | | mm ² | 1 x (25 - 185) |
| Cu strip (number of segments x width x segment thickness) | | | |
| Box terminal | | | |
| | min. | mm | 2 x 9 x 0.8 |
| | max. | mm | 10 x 16 x 0.8 (2x) 8 x 15.5 x 0,8 |
| Bolt terminal and rear-side connection | | | |
| Flat copper strip, with holes | min. | mm | 2 x 16 x 0.8 |
| Flat copper strip, with holes | max. | mm | 10 x 24 x 0.8 |
| Copper busbar (width x thickness) | mm | | |
| Bolt terminal and rear-side connection | | | |
| Screw connection | | | M8 |
| Direct on the switch | | | |
| | min. | mm | 16 x 5 |
| | max. | mm | 24 x 8 |
| Control cables | | | |
| | | mm ² | 1 x (0.75 - 2.5) 2 x (0.75 - 1.5) |

Design verification as per IEC/EN 61439

| | | | |
|--|------------------|----|--|
| Technical data for design verification | | | |
| Rated operational current for specified heat dissipation | I _n | A | 250 |
| Equipment heat dissipation, current-dependent | P _{vid} | W | 51.56 |
| Operating ambient temperature min. | | °C | -25 |
| Operating ambient temperature max. | | °C | 70 |
| IEC/EN 61439 design verification | | | |
| 10.2 Strength of materials and parts | | | |
| 10.2.2 Corrosion resistance | | | |
| 10.2.2.1 Verification of thermal stability of enclosures | | | Meets the product standard's requirements. |
| 10.2.2.2 Verification of resistance of insulating materials to normal heat | | | Meets the product standard's requirements. |
| 10.2.2.3 Verification of resistance of insulating materials to abnormal heat and fire due to internal electric effects | | | Meets the product standard's requirements. |
| 10.2.4 Resistance to ultra-violet (UV) radiation | | | Meets the product standard's requirements. |

| | | |
|--|--|--|
| 10.2.5 Lifting | | Does not apply, since the entire switchgear needs to be evaluated. |
| 10.2.6 Mechanical impact | | Does not apply, since the entire switchgear needs to be evaluated. |
| 10.2.7 Inscriptions | | Meets the product standard's requirements. |
| 10.3 Degree of protection of ASSEMBLIES | | Does not apply, since the entire switchgear needs to be evaluated. |
| 10.4 Clearances and creepage distances | | Meets the product standard's requirements. |
| 10.5 Protection against electric shock | | Does not apply, since the entire switchgear needs to be evaluated. |
| 10.6 Incorporation of switching devices and components | | Does not apply, since the entire switchgear needs to be evaluated. |
| 10.7 Internal electrical circuits and connections | | Is the panel builder's responsibility. |
| 10.8 Connections for external conductors | | Is the panel builder's responsibility. |
| 10.9 Insulation properties | | |
| 10.9.2 Power-frequency electric strength | | Is the panel builder's responsibility. |
| 10.9.3 Impulse withstand voltage | | Is the panel builder's responsibility. |
| 10.9.4 Testing of enclosures made of insulating material | | Is the panel builder's responsibility. |
| 10.10 Temperature rise | | The panel builder is responsible for the temperature rise calculation. Eaton will provide heat dissipation data for the devices. |
| 10.11 Short-circuit rating | | Is the panel builder's responsibility. The specifications for the switchgear must be observed. |
| 10.12 Electromagnetic compatibility | | Is the panel builder's responsibility. The specifications for the switchgear must be observed. |
| 10.13 Mechanical function | | The device meets the requirements, provided the information in the instruction leaflet (IL) is observed. |

Technical data ETIM 7.0

| | | | |
|---|----|--|--|
| Low-voltage industrial components (EG000017) / Power circuit-breaker for trafo/generator/installation protection (EC000228) | | | |
| Electric engineering, automation, process control engineering / Low-voltage switch technology / Circuit breaker (LV < 1 kV) / Circuit breaker for power transformer, generator and system protection (ecf@ss10.0.1-27-37-04-09 [AJZ716013]) | | | |
| Rated permanent current I _u | A | 250 | |
| Rated voltage | V | 690 - 690 | |
| Rated short-circuit breaking capacity I _{cu} at 400 V, 50 Hz | kA | 70 | |
| Overload release current setting | A | 100 - 250 | |
| Adjustment range short-term delayed short-circuit release | A | 0 - 0 | |
| Adjustment range undelayed short-circuit release | A | 2 - 12 | |
| Integrated earth fault protection | | No | |
| Type of electrical connection of main circuit | | Screw connection | |
| Device construction | | Built-in device fixed built-in technique | |
| Suitable for DIN rail (top hat rail) mounting | | No | |
| DIN rail (top hat rail) mounting optional | | Yes | |
| Number of auxiliary contacts as normally closed contact | | 0 | |
| Number of auxiliary contacts as normally open contact | | 0 | |
| Number of auxiliary contacts as change-over contact | | 0 | |
| With switched-off indicator | | No | |
| With under voltage release | | No | |
| Number of poles | | 3 | |
| Position of connection for main current circuit | | Front side | |
| Type of control element | | Rocker lever | |
| Complete device with protection unit | | Yes | |
| Motor drive integrated | | No | |
| Motor drive optional | | Yes | |
| Degree of protection (IP) | | IP20 | |

Characteristics

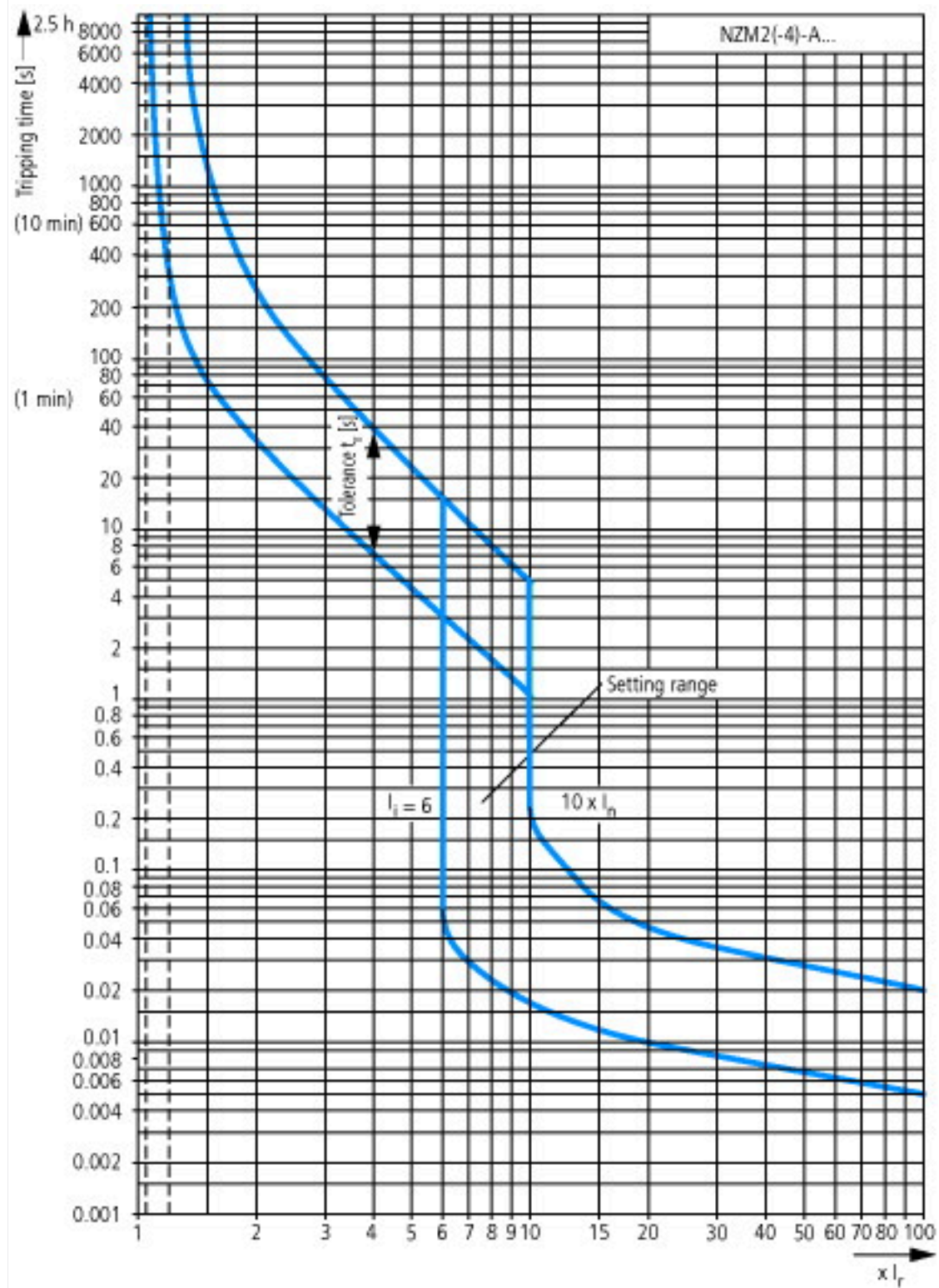

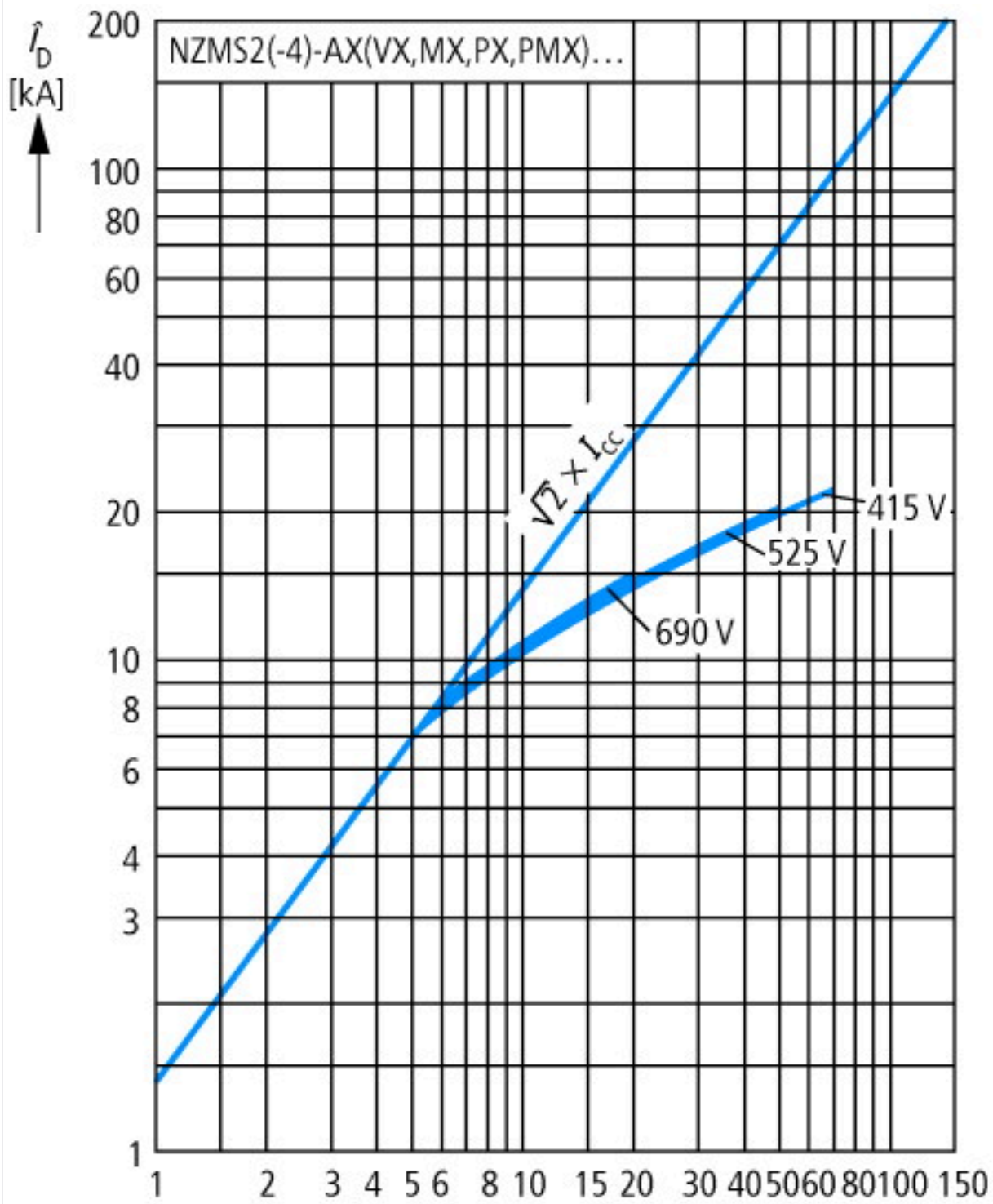

Let-through current

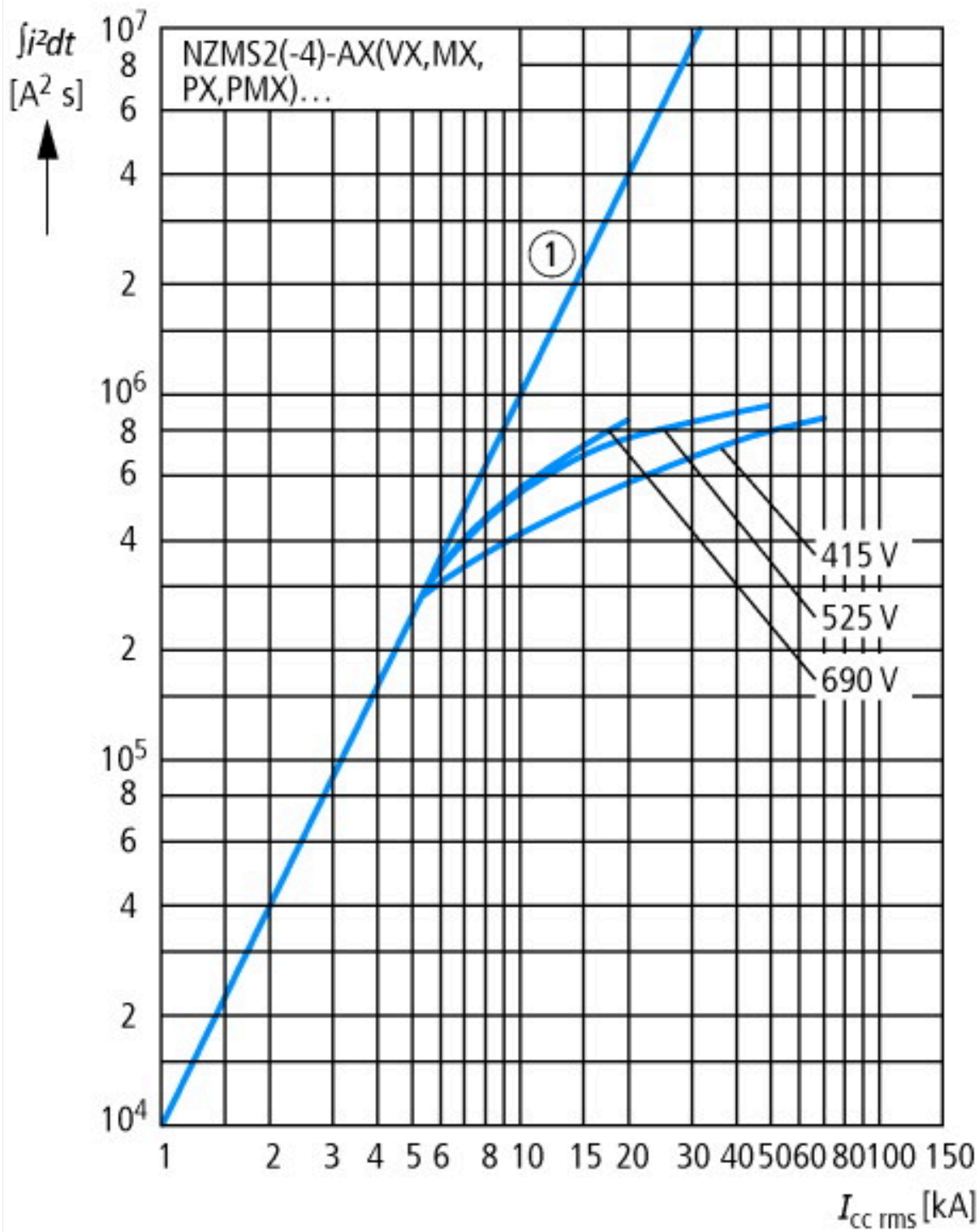

Let-through energy

Dimensions

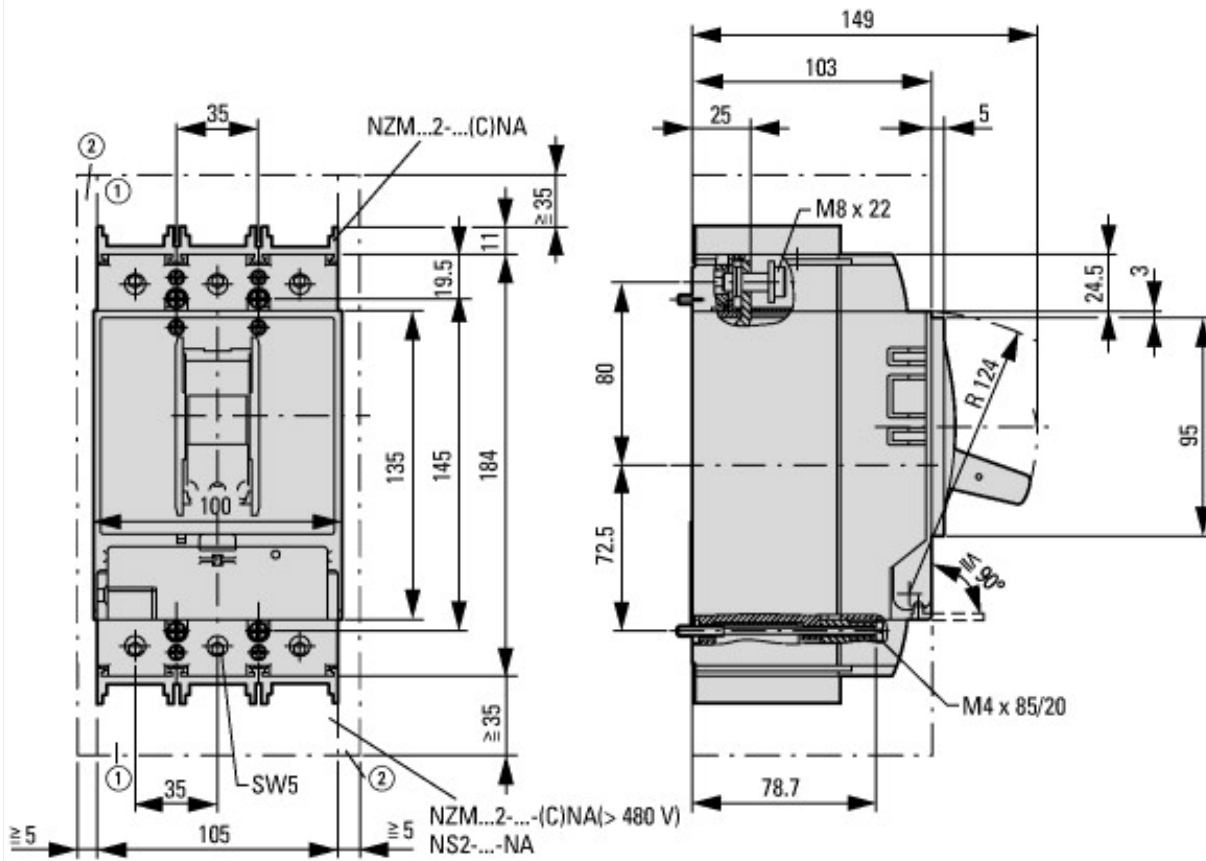

- ① Blow out area, minimum clearance to adjacent parts
- ② Minimum clearance to adjacent parts



Additional product information (links)

IL012099ZU NZM2-PXR circuit-breaker, basic device, NZM2-PXR Circuit-Breaker, basic unit

IL012099ZU NZM2-PXR circuit-breaker, basic device, NZM2-PXR Circuit-Breaker, basic unit

https://es-assets.eaton.com/DOCUMENTATION/AWA_INSTRUCTIONS/IL012099ZU2019_03.pdf

Temperature dependency, Derating

<http://ecat.moeller.net/flip-cat/?edition=HPLEN&startpage=17.172>

additional technical information for NZM power switch

https://es-assets.eaton.com/DOCUMENTATION/PDF/nzm_technic_de_en.pdf