







Circuit-breaker, 3p, 50A

Referencia **NZMH2-A50**
 Catalog No. **259096**

Similar to illustration

Delivery program

Product range			Circuit-breaker
Protective function			System and cable protection
Standard/Approval			IEC
Installation type			Fixed
Release system			Thermomagnetic release
Construction size			NZM2
Number of poles			3 pole
Standard equipment			Screw connection
Switching capacity			
400/415 V 50 Hz	I_{cu}	kA	150
Rated current = rated uninterrupted current			
Rated current = rated uninterrupted current	$I_n = I_u$	A	50
Setting range			
Overload trip			
	I_r	A	40 - 50
Short-circuit releases			
			
Non-delayed	$I_i = I_n \times \dots$		6 - 10
			
Short-circuit releases	I_{rm}	A	300 - 500
			

Technical data

General			
Standards			IEC/EN 60947
Protection against direct contact			Finger and back of hand proof to VDE 0106 Part 100
Climatic proofing			Damp heat, constant, to IEC 60068-2-78 Damp heat, cyclic, to IEC 60068-2-30
Ambient temperature			
Ambient temperature, storage		°C	- 40 - + 70
Operation		°C	-25 - +70
Mechanical shock resistance (10 ms half-sinusoidal shock) according to IEC 60068-2-27		g	20 (half-sinusoidal shock 20 ms)
Safe isolation to EN 61140			
Between auxiliary contacts and main contacts		V AC	500
between the auxiliary contacts		V AC	300
Weight		kg	2.345
Mounting position			Vertical and 90° in all directions



With XFI earth-fault release:
 - NZM1, N1, NZM2, N2: vertical and 90° in all directions
 with plug-in unit
 - NZM1, N1, NZM2, N2: vertical, 90° right/left
 with withdrawable unit:
 - NZM3, N3: vertical, 90° right/left
 - NZM4, N4: vertical
 with remote operator:
 - NZM2, N(S)2, NZM3, N(S)3, NZM4, N(S)4: vertical and 90° in all directions

Direction of incoming supply		as required
Degree of protection		
Device		In the operating controls area: IP20 (basic degree of protection)
Enclosures		With insulating surround: IP40 With door coupling rotary handle: IP66
Terminations		Tunnel terminal: IP10 Phase isolator and strip terminal: IP00
Other technical data (sheet catalogue)		Temperature dependency, Derating

Circuit-breakers

Rated current = rated uninterrupted current	$I_n = I_u$	A	50
Rated surge voltage invariability	U_{imp}		
Main contacts		V	8000
Auxiliary contacts		V	6000
Rated operational voltage	U_e	V AC	690
Rated operational voltage	U_e	V DC	750

The following settings are required in order to ensure correct tripping:

The fast-response release will take longer to respond when used for DC applications. Because of this, the setting on the trip block inscription, which is specified for AC currents, must be set to a lower value for DC currents.

DC correction factor for instantaneous release response value:

- o NZM1: 1.25
- o NZM2: 1.35
- o NZM3: 1.45

Example: NZM3 $I_e = 500A$. Desired DC tripping current: $10 * I_e = 5000A$.

Calculation:

- Desired DC value / correction factor = AC setting on trip block
- $5000A / 1.45 = 3448 A \sim 7 * I_e =$ Value that needs to be set on the trip block

Permitted circuit configurations:



Overvoltage category/pollution degree			III/3
Rated insulation voltage	U_i	V	1000
Use in unearthed supply systems		V	≤ 690

Switching capacity

Rated short-circuit making capacity	I_{cm}		
240 V	I_{cm}	kA	330
400/415 V	I_{cm}	kA	330
440 V 50/60 Hz	I_{cm}	kA	286
525 V 50/60 Hz	I_{cm}	kA	105
690 V 50/60 Hz	I_c	kA	40
Rated short-circuit breaking capacity I_{cn}	I_{cn}		

Icu to IEC/EN 60947 test cycle O-t-CO	I _{cu}	kA	
240 V 50/60 Hz	I _{cu}	kA	150
400/415 V 50/60 Hz	I _{cu}	kA	150
440 V 50/60 Hz	I _{cu}	kA	130
525 V 50/60 Hz	I _{cu}	kA	50
690 V 50/60 Hz	I _{cu}	kA	20
500 V DC	I _{cu}	kA	60
750 V DC	I _{cu}	kA	60
Ics to IEC/EN 60947 test cycle O-t-CO-t-CO	I _{cs}	kA	
240 V 50/60 Hz	I _{cs}	kA	150
400/415 V 50/60 Hz	I _{cs}	kA	150
440 V 50/60 Hz	I _{cs}	kA	130
525 V 50/60 Hz	I _{cs}	kA	37.5
690 V 50/60 Hz	I _{cs}	kA	5
500 V DC	I _{cs}	kA	15
750 V DC	I _{cs}	kA	15
			Maximum back-up fuse, if the expected short-circuit currents at the installation location exceed the switching capacity of the circuit-breaker.
Rated short-time withstand current			
t = 0.3 s	I _{cw}	kA	1.9
t = 1 s	I _{cw}	kA	85
Utilization category to IEC/EN 60947-2			A
Lifespan, mechanical(of which max. 50 % trip by shunt/undervoltage release)	Operations		20000
Lifespan, electrical			
AC-1			
400 V 50/60 Hz	Operations		10000
415 V 50/60 Hz	Operations		10000
690 V 50/60 Hz	Operations		7500
AC--3			
400 V 50/60 Hz	Operations		6500
415 V 50/60 Hz	Operations		6500
690 V 50/60 Hz	Operations		5000
DC-1			
500 V DC	Operations		7500
750 V DC	Operations		7500
DC - 3			
500 V DC	Operations		3000
750 V DC	Operations		3000
Max. operating frequency		Ops/h	120
Total break time at short-circuit		ms	< 10

Terminal capacity

Standard equipment			Screw connection
Optional accessories			Box terminal Tunnel terminal connection on rear
Round copper conductor			
Box terminal			
Solid		mm ²	1 x (10 - 16) 2 x (6 - 16)
Stranded		mm ²	1 x (25 - 185) 2 x (25 - 70)
Tunnel terminal			
Solid		mm ²	1 x 16
Stranded			
1-hole		mm ²	1 x (25 - 185)
Bolt terminal and rear-side connection			

Direct on the switch			
Solid		mm ²	1 x (10 - 16) 2 x (6 - 16)
Stranded		mm ²	1 x (25 - 185) 2 x (25 - 70)
Al circular conductor			
Tunnel terminal			
Solid		mm ²	1 x 16
Stranded			
Stranded		mm ²	1 x (25 - 185)
Bolt terminal and rear-side connection			
Direct on the switch			
Solid		mm ²	1 x (10 - 16) 2 x (10 - 16)
Stranded		mm ²	1 x (25 - 50) 2 x (25 - 50)
Cu strip (number of segments x width x segment thickness)			
Box terminal			
	min.	mm	2 x 9 x 0.8
	max.	mm	10 x 16 x 0.8 (2x) 8 x 15.5 x 0,8
Bolt terminal and rear-side connection			
Flat copper strip, with holes	min.	mm	2 x 16 x 0.8
Flat copper strip, with holes	max.	mm	10 x 24 x 0.8
Copper busbar (width x thickness)		mm	
Bolt terminal and rear-side connection			
Screw connection			M8
Direct on the switch			
	min.	mm	16 x 5
	max.	mm	24 x 8
Control cables			
		mm ²	1 x (0.75 - 2.5) 2 x (0.75 - 1.5)

Design verification as per IEC/EN 61439

Technical data for design verification			
Intensidad asignada de empleo para disipación térmica específica	I _n	A	50
Disipación térmica del equipo, en función de la intensidad	P _{vid}	W	17.03
Temperatura ambiente mínima de funcionamiento		°C	-25
Temperatura ambiente máxima de funcionamiento		°C	70
IEC/EN 61439 design verification			
10.2 Strength of materials and parts			
10.2.2 Resistencia a la corrosión			Cumple con los requisitos de la norma del producto.
10.2.3.1 Verificación de la estabilidad térmica de los armarios			Cumple con los requisitos de la norma del producto.
10.2.3.2 Verificación de la resistencia de los materiales aislantes en condiciones de calor normales			Cumple con los requisitos de la norma del producto.
10.2.3.3. Verificación de la resistencia de los materiales aislantes al calor excesivo y al fuego debido a los efectos eléctricos internos			Cumple con los requisitos de la norma del producto.
10.2.4 Resistencia a radiación ultravioleta (UV)			Cumple con los requisitos de la norma del producto.
10.2.5 Elevación			No se aplica, ya que todo el equipo de conmutación debe ser evaluado.
10.2.6 Impacto mecánico			No se aplica, ya que todo el equipo de conmutación debe ser evaluado.
10.2.7 Inscripciones			Cumple con los requisitos de la norma del producto.
10.3 Grado de protección de montajes			No se aplica, ya que todo el equipo de conmutación debe ser evaluado.
10.4 Distancias de separación y fuga			Cumple con los requisitos de la norma del producto.
10.5 Protección contra descargas eléctricas			No se aplica, ya que todo el equipo de conmutación debe ser evaluado.
10.6 Incorporación de dispositivos y componentes de conmutación			No se aplica, ya que todo el equipo de conmutación debe ser evaluado.
10.7 Conexiones y circuitos eléctricos internos			Es responsabilidad del cuadrista.
10.8 Conexiones de conductores externos			Es responsabilidad del cuadrista.

10.9 Insulation properties			
10.9.2 Resistencia eléctrica de frecuencia de alimentación			Es responsabilidad del cuadrista.
10.9.3 Tensión de impulso soportada			Es responsabilidad del cuadrista.
10.9.4 Pruebas de armarios hechos de material aislante			Es responsabilidad del cuadrista.
10.10 Aumento de la temperatura			El cuadrista es responsable del cálculo del aumento de la temperatura. Eaton proporcionará datos de disipación de calor para los dispositivos.
10.11 Resistencia a los cortocircuitos			Es responsabilidad del cuadrista. Deben tenerse en cuenta las especificaciones de la aparamenta.
10.12 Compatibilidad electromagnética			Es responsabilidad del cuadrista. Deben tenerse en cuenta las especificaciones de la aparamenta.
10.13 Función mecánica			El dispositivo cumple los requisitos, siempre que se observe la información del folleto de instrucciones (IL).

Technical data ETIM 7.0

Conmutadores en baja tensión (EG000017) / Disyuntor para protección de transformador/generador/instalación (EC000228)			
Tecnología electrónica, de automatización y de mando de procesos / Tecnología de conmutación de baja tensión / Interruptor de potencia, interruptor de potencia (baja tensión) / Interruptor de potencia de transformador, generador y protección de instal. (ecl@ss10.0.1-27-37-04-09 [AJZ716013])			
Intensidad permanente nominal Iu	Ampere	50	
Intervalo de tensión nominal	Volt	690 - 690	
Capacidad de desconexión de cortocircuito nominal Icu a 400 V, 50 Hz	kiloamperes	450	
Ajuste intervalo protector sobrecarga	Ampere	40 - 50	
Liberación del corto circuito con retado a corto plazo del intervalo de ajuste	Ampere	0 - 0	
Liberación del corto circuito sin retardo del intervalo de ajuste	Ampere	300 - 500	
Protección de fuga a tierra integrada		No	
Tipo de conexión del circuito de corriente principal		Conexión enroscada	
Construcción de dispositivo		Técnica integrada fija para dispositivo integrado	
Compatible para montaje en rieles DIN (rieles simétricos)		No	
Número de contactos auxiliares como contacto normalmente cerrado		0	
Número de contactos auxiliares como contacto normalmente abierto		0	
Número de contactos auxiliares como contacto de intercambio		0	
Indicador de desconexión disponible		No	
Con liberación de bajo voltaje		No	
Número de polos		3	
Posición de la conexión para el circuito principal de tensión		Parte frontal	
Tipo de elemento de control		Palanca de balancín	
Accionamiento por motor integrado		No	
Accionamiento por motor opcional		Sí	
Grado de protección (IP)		IP20	

Characteristics

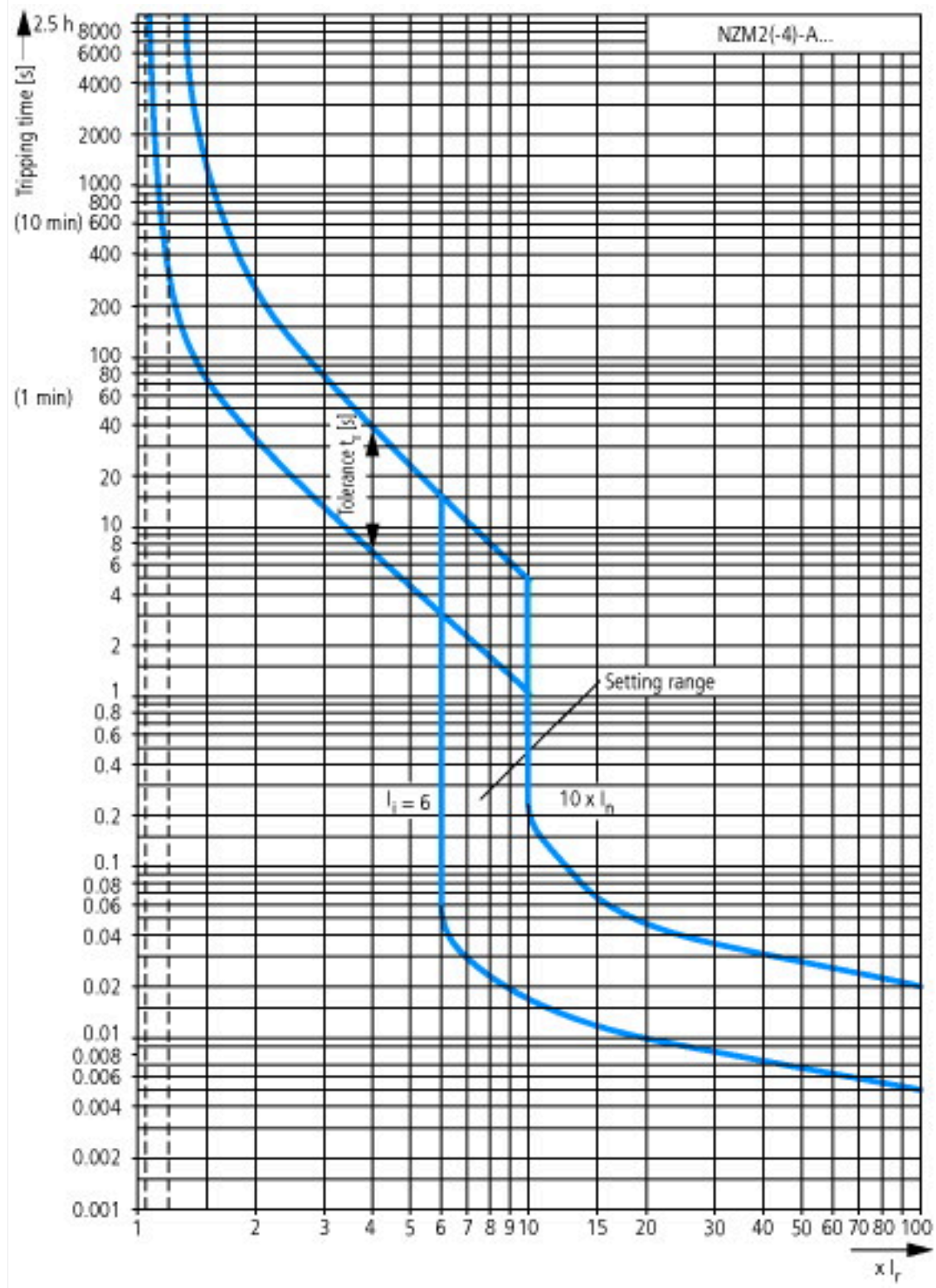



Let-through current

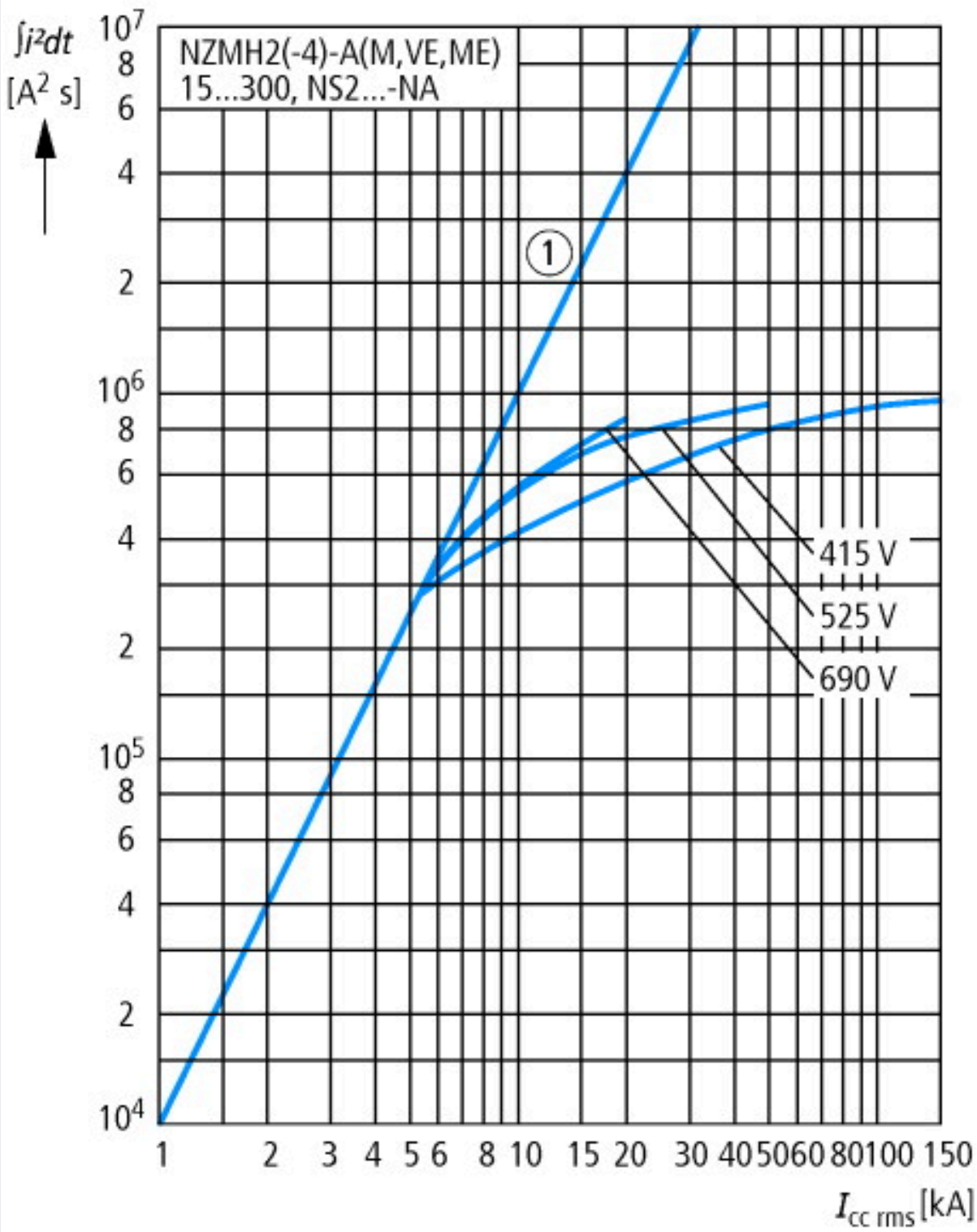

Let-through energy

Dimensions

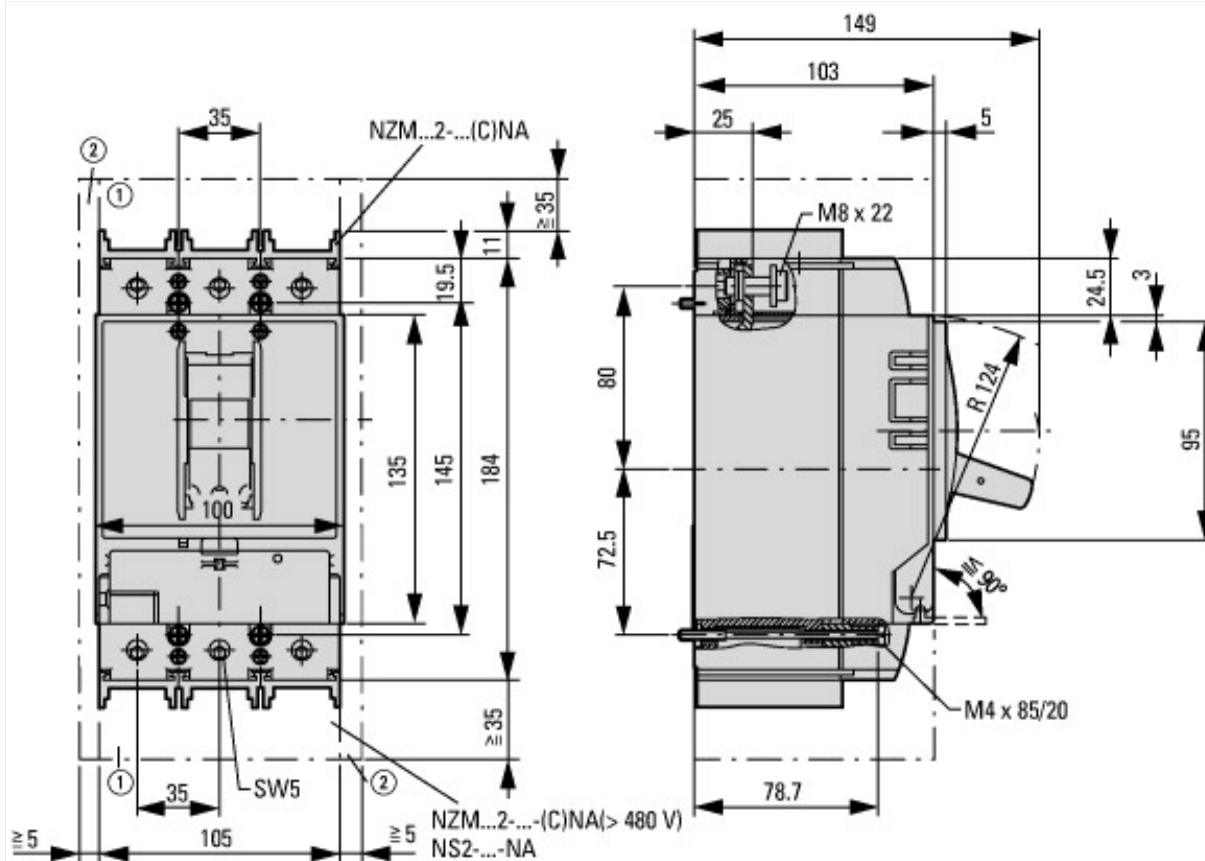

- ① Blow out area, minimum clearance to adjacent parts
- ② Minimum clearance to adjacent parts



Additional product information (links)

IL01206006Z (AWA1230-1916) Circuit-Breaker, basic unit

IL01206006Z (AWA1230-1916) Circuit-Breaker, basic unit	https://es-assets.eaton.com/DOCUMENTATION/AWA_INSTRUCTIONS/IL01206006Z2015_11.pdf
Influencia térmica, reducción de potencia	http://de.ecat.moeller.net/flip-cat/?edition=HPLTF&startpage=17.172
CurveSelect characteristics program	http://www.eaton.eu/DE/Europe/Electrical/CustomerSupport/ConfigurationTools/CharacteristicsProgram/index.htm
additional technical information for NZM power switch	https://es-assets.eaton.com/DOCUMENTATION/PDF/nzm_technic_de_en.pdf