

With or without terminals

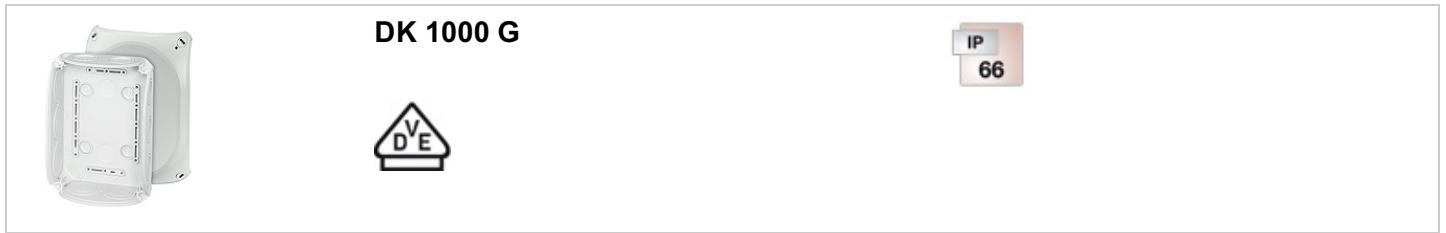

- without terminals
- with elastic membranes, which can be removed for cable entry via cable glands, sealing range 9.0-21.0 mm
- with two cable entries in the bottom, sealing range Ø 9.0-20.0 mm
- lid fasteners sealable without accessories
- retaining strap and external brackets for wall fixing included
- colour: grey, RAL 7035
- To close opened membranes use grommets type EDK. Degree of protection = IP 66.

rated insulation voltage	U <sub>i</sub> = 1000 V a.c./d.c.
material	PP (polypropylene)
degree of protection	IP 66
mounting width	150 mm
mounting height	97 mm
max. installation depth	62 mm
width	180 mm
height	130 mm
depth	77 mm
weight	0,251 kg
in accordance with	IEC 60670-22

Drawings

Dimension drawing

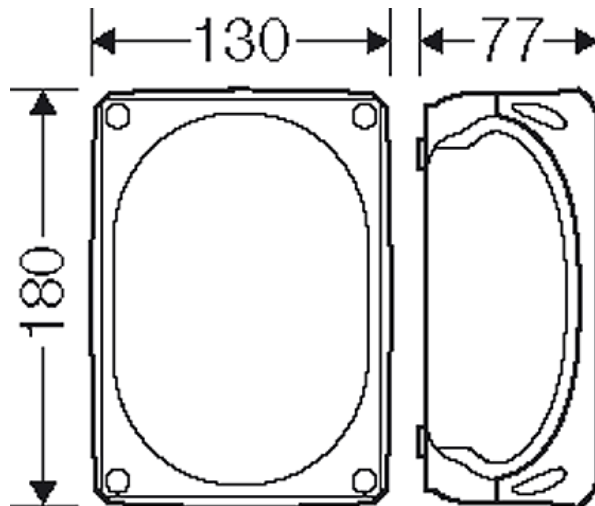

With or without terminals



DK 1000 G

IP 66



Detail mass

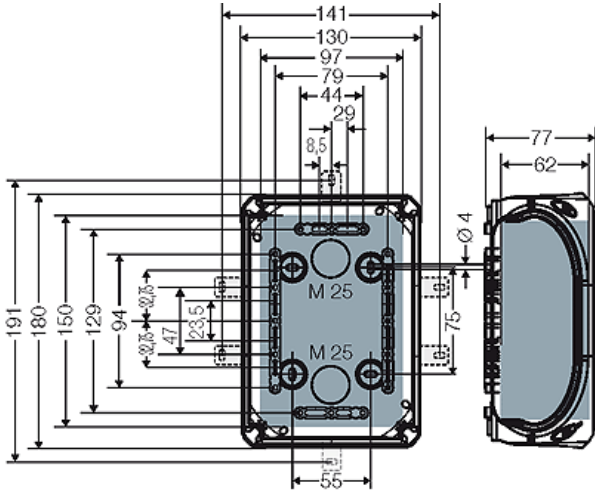

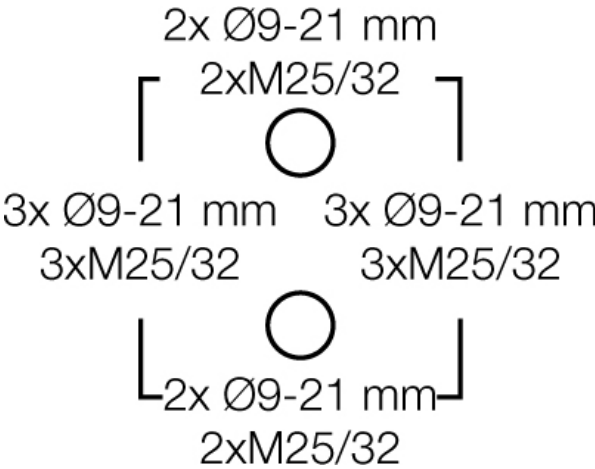

Box walls



Operating and ambient conditions

Application area	Suitable for indoor installation and outdoor installation, protected against weather influences
Ambient temperature	Maximum value + 40 °C Minimum value - 25 °C
Fire protection in the event of internal faults	Demands placed on electrical devices from standards and laws Minimum requirements - Glow wire test in accordance with IEC 60695-2-11: - 650°C for boxes and cable glands - 850°C for parts of insulating material necessary to retain current carrying parts in position
Burning behaviour	Glow wire test IEC 60695-2-11: 750 °C UL Subject 94: V-2 flame-retardant self-extinguishing
Degree of protection against mechanical load	IK07 (2 Joule)
Toxic behaviour	halogen-free silicone-free "halogen-free" in accordance with the examination of the cables and insulated wires - corrosiveness of fumes - as per IEC 60754-2

With or without terminals

	<b>DK 1000 G</b>	
		

Note:

For material properties see technical data.