



Empty boxes



FP 0411

- Built-in dimensions W 306 x H 486 x D 140 mm
- door fastener with tool operation
- with closing plates for box walls



- max. installation depth with built-in mounting plate 136 mm, with built-in DIN rail 125 mm
- box size 4
- with transparent door
- sealing device for door sealing order separately
- please order DIN rails, mounting plates or covers additionally
- connector: 6 items
- order flanges separately
- material: PC (polycarbonate)
- protection class: II
- colour: grey, RAL 7035

width	366 mm
height	546 mm
depth	163 mm
weight	4,3 kg

Drawings

Dimension drawing

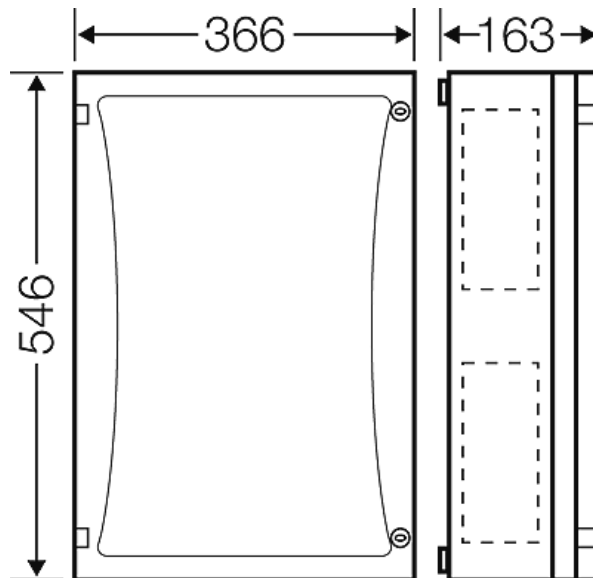

Empty boxes



FP 0411

- Built-in dimensions W 306 x H 486 x D 140 mm
- door fastener with tool operation
- with closing plates for box walls



Detail mass

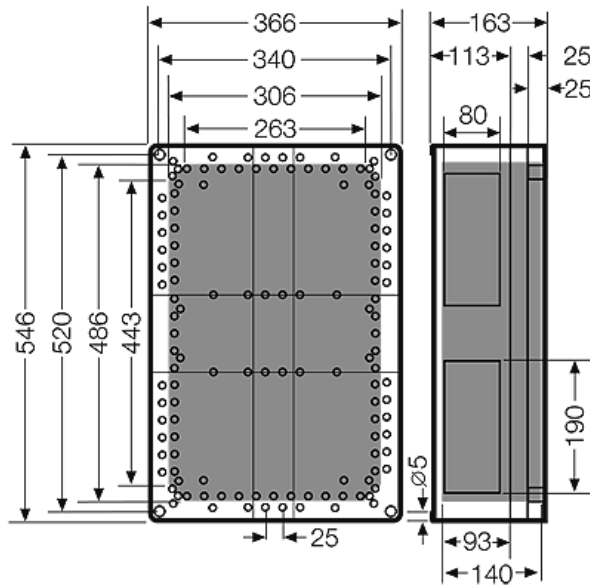

Box walls

Operating and ambient conditions

Application area	Suitable for indoor installation and outdoor installation, protected against weather influences However, pay attention to the climatic effects on the installed equipment, for example, high or low ambient temperatures or formation of condensed water see technical information
Ambient temperature	Maximum value + 70 °C Minimum value - 25 °C
Fire protection in the event of internal faults	Demands placed on electrical devices from standards and laws Minimum requirements - Glow wire test in accordance with IEC 60695-2-11: - 650°C for boxes and cable glands - 850°C for parts of insulating material necessary to retain current carrying parts in position
Burning behaviour	Glow wire test IEC 60695-2-11: 960 °C UL Subject 94: V-2 flame-retardant self-extinguishing
Degree of protection against mechanical load	IK08 (5 Joule)
Toxic behaviour	halogen-free silicone-free "halogen-free" in accordance with the examination of the cables and insulated wires - corrosiveness of fumes - as per IEC 60754-2
Note:	Additional information for protected outdoor installation: - In order to keep the maximum permissible ambient temperature of the installed equipment as well for the prevention from condensation additional measures as ventilation and/or heating may be necessary. For material properties see technical data.