

”Weatherproof“ for outdoor installation







KF 1010 B

- 2.5-10 mm², Cu 3~

IP
66/67

IP
69







- terminal with 2 clamping units per pole
- 5-pole per pole 6 x 2.5 mm² r / f, 4 x 4 mm² r / f, 4 x 6 mm² r / f, 4 x 10 mm² r / f, 2 x 16 mm² s / f
- with two cable entries M 25 from the rear side
- cable entries via knockouts, order ASS separately (see cable entry systems LES)
- "weatherproof" resistant to weather influences (UV due to solar radiation, protected against rainwater, temperature resistant, impact resistant, etc.)
- saltwater-proof
- "offshore applications"
- lid fasteners sealable without accessories
- retaining strap and external brackets for wall fixing included
- colour: black, RAL 9011

rated insulation voltage	U _i = 690 V a.c./d.c.
rated current:	63 A
material	PC-GFS (polycarbonate)
degree of protection	IP 66 / IP 67 / IP 69 IP 67, temporary submersion IP 69, water pressure max. 100 bar, water temperature max. 80 °C, distance ≥ 0.15 m
width	180 mm
height	130 mm
depth	77 mm
weight	0,388 kg
tightening torque for terminal	2.0 Nm
in accordance with	IEC 60670-22
in accordance with	DNV GL - Certificate No: TAE00000EE Russian Maritime Register of Shipping, technical documentation is approved by the letter No. 250-A-1180-108795

Drawings

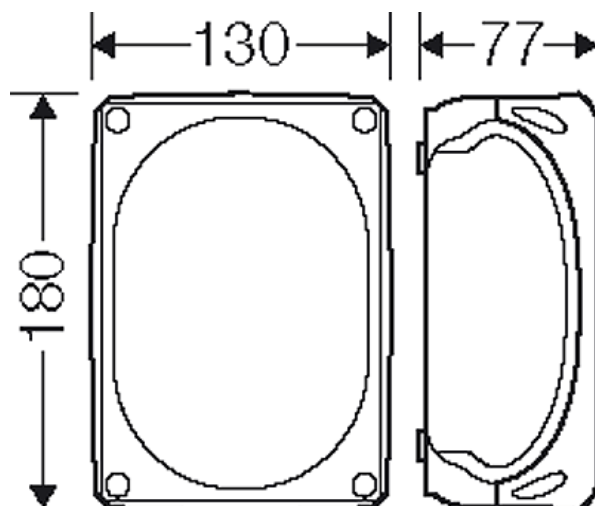
Dimension drawing



”Weatherproof“ for outdoor installation



KF 1010 B

- 2.5-10 mm², Cu 3~

IP
66/67

IP
69







Detail mass

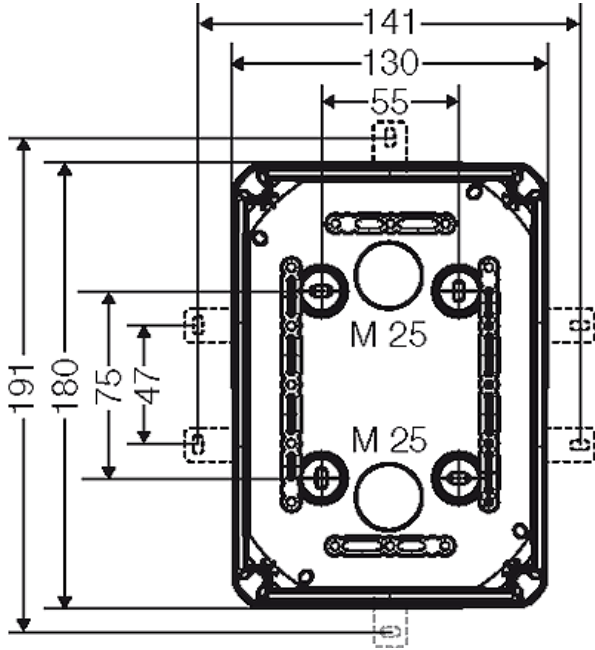



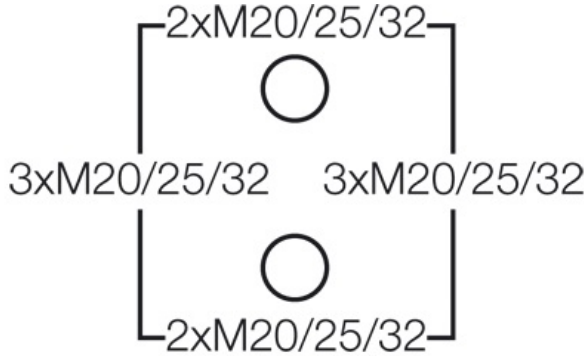

Box walls



Operating and ambient conditions

Application area	Suitable for for outdoor installation (harsh environment and/or outdoor). To reduce the formation and accumulation of condensed water see technical information.
Resistant to occasional cleaning procedures (direct jet)	Resistance to occasional cleaning procedures (direct jet) with high-pressure cleaner without cleaning additives, water pressure: max 100 bar, water temperature: max 80 °C, distance ≥ 0.15 m, in accordance with DIN EN 60529:2014-09 (IEC 60529:2013) = IP 69. Only with cable entries HENSEL AKM or ASS.
Ambient temperature	Average value over 24 hours + 55 °C Maximum value + 70 °C Minimum value - 25 °C
Relative humidity	50% at 40° C short-time 100% at 25° C
Fire protection in the event of internal faults	Demands placed on electrical devices from standards and laws Minimum requirements

”Weatherproof“ for outdoor installation

	<p>KF 1010 B</p> <ul style="list-style-type: none"> • 2.5-10 mm², Cu 3~ 			
				

	<ul style="list-style-type: none"> - Glow wire test in accordance with IEC 60695-2-11: - 650°C for boxes and cable glands - 850°C for parts of insulating material necessary to retain current carrying parts in position
<p>Burning behaviour</p>	<p>Glow wire test IEC 60695-2-11: 960 °C UL Subject 94: V-0 flame-retardant self-extinguishing</p>
<p>Degree of protection against mechanical load</p>	<p>IK09 (10 Joule)</p>
<p>Toxic behaviour</p>	<p>halogen-free silicone-free "halogen-free" in accordance with the examination of the cables and insulated wires - corrosiveness of fumes - as per IEC 60754-2</p>
<p>Note:</p>	<p>For material properties see technical data.</p>