



”Weatherproof“ for outdoor installation





KF 1616 G

- 6-16 mm², Cu 3~

IP 66/67 IP 69







- terminal with 2 clamping units per pole
- 5-pole per pole 6 x 6 mm² r / f, 4 x 10 mm² r / f, 4 x 16 mm² s / f, 4 x 25 mm² s / f, 2 x 35 mm² s / f
- with two cable entries M 32 from the rear side
- cable entries via knockouts, order AKM separately (see cable entry systems LES)
- "weatherproof" resistant to weather influences (UV due to solar radiation, protected against rainwater, temperature resistant, impact resistant, etc.)
- saltwater-proof
- "offshore applications"
- lid fasteners sealable without accessories
- external brackets for wall fixing included
- colour: grey, RAL 7035

rated insulation voltage	U _i = 690 V a.c./d.c.
rated current:	102 A
material	PC-GFS (polycarbonate)
degree of protection	IP 66 / IP 67 / IP 69 IP 67, temporary submersion IP 69, water pressure max. 100 bar, water temperature max. 80 °C, distance ≥ 0.15 m
width	210 mm
height	155 mm
depth	92 mm
weight	0,704 kg
tightening torque for terminal	3.0 Nm
in accordance with	IEC 60670-22
in accordance with	DNV GL - Certificate No: TAE00000EE Russian Maritime Register of Shipping, technical documentation is approved by the letter No. 250-A-1180-108795

Drawings

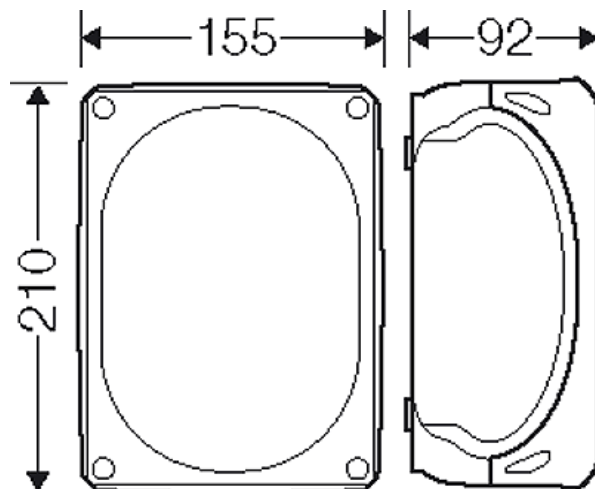
Dimension drawing



”Weatherproof“ for outdoor installation



KF 1616 G

- 6-16 mm², Cu 3~

IP
66/67

IP
69







Detail mass

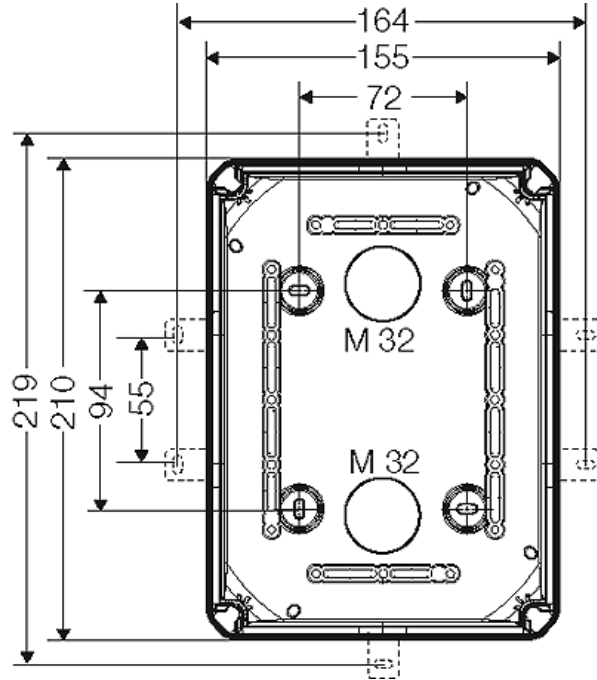

Box walls

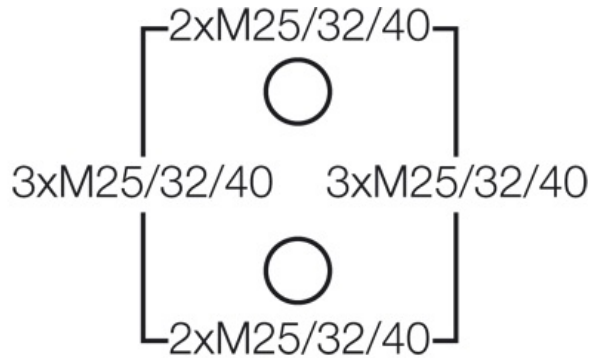

Operating and ambient conditions

Application area	Suitable for outdoor installation (harsh environment and/or outdoor). To reduce the formation and accumulation of condensed water see technical information.
Resistant to occasional cleaning procedures (direct jet)	Resistance to occasional cleaning procedures (direct jet) with high-pressure cleaner without cleaning additives, water pressure: max 100 bar, water temperature: max 80 °C, distance ≥ 0.15 m, in accordance with DIN EN 60529:2014-09 (IEC 60529:2013) = IP 69. Only with cable entries HENSEL AKM or ASS.
Ambient temperature	Average value over 24 hours + 55 °C Maximum value + 70 °C Minimum value - 25 °C
Relative humidity	50% at 40° C short-time 100% at 25° C
Fire protection in the event of internal faults	Demands placed on electrical devices from standards and laws

”Weatherproof“ for outdoor installation

	<p>KF 1616 G</p>			
	<ul style="list-style-type: none"> • 6-16 mm², Cu 3~ 			
				

Minimum requirements
 - Glow wire test in accordance with IEC 60695-2-11:
 - 650°C for boxes and cable glands
 - 850°C for parts of insulating material necessary to retain current carrying parts in position

Burning behaviour

Glow wire test IEC 60695-2-11: 960 °C
 UL Subject 94: V-0
 flame-retardant
 self-extinguishing

Degree of protection against mechanical load

IK09 (10 Joule)

Toxic behaviour

halogen-free
 silicone-free
 "halogen-free" in accordance with the examination of the cables and insulated wires - corrosiveness of fumes - as per IEC 60754-2

Note:

For material properties see technical data.