



Empty boxes



Mi 0210

- Built-in dimensions W 275 x H 275 x D 195 mm



IP
65

- max. installation depth with built-in mounting plate 191 mm, with built-in DIN rail 180 mm
- box size 2
- please order DIN rails, mounting plates or covers additionally
- with transparent lid
- lid fasteners for tool operation
- material: PC (polycarbonate)
- protection class: II
- colour: grey, RAL 7035

mounting height	275 mm
mounting width	275 mm
width	300 mm
height	300 mm
depth	214 mm
weight	2,169 kg

Drawings

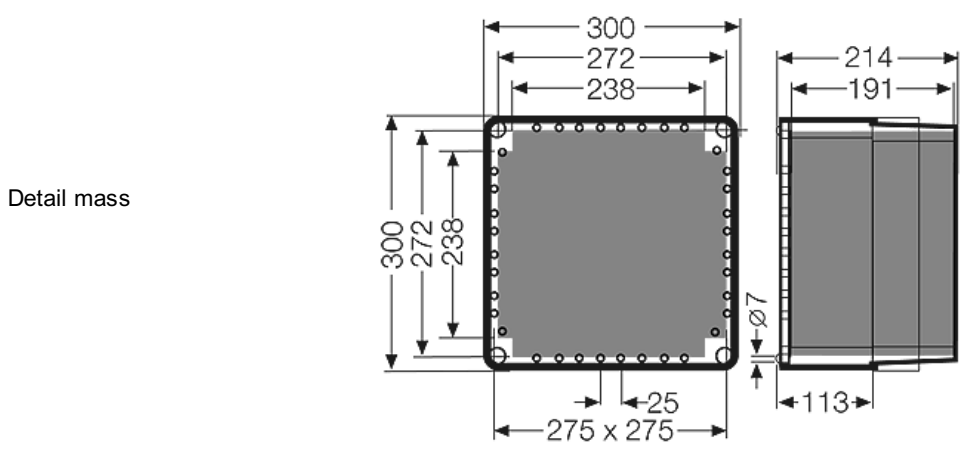
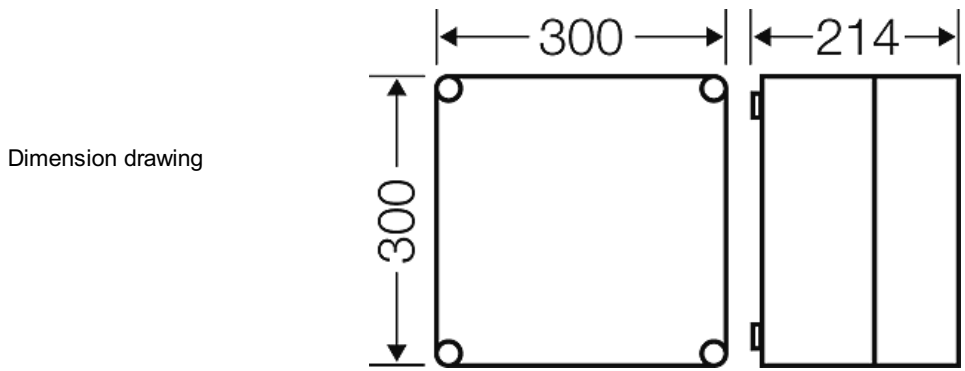

Empty boxes



Mi 0210

- Built-in dimensions W 275 x H 275 x D 195 mm



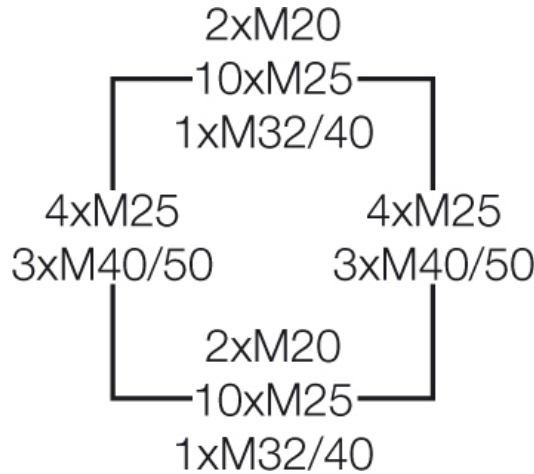

Box walls



Operating and ambient conditions

Application area	Suitable for indoor installation and outdoor installation, protected against weather influences However, pay attention to the climatic effects on the installed equipment, for example, high or low ambient temperatures or formation of condensed water see technical information
Resistant to occasional cleaning procedures (direct jet)	Resistance to occasional cleaning procedures (direct jet) with high-pressure cleaner without cleaning additives, water pressure: max 100 bar, water temperature: Max. 80° C, distance => 0.15 m, in accordance with IP 69 requirements, single enclosure without lid equipment (no enclosure assembly), enclosure and cable glands at least IP 65.
Ambient temperature	Maximum value + 70 °C Minimum value - 25 °C
Fire protection in the event of internal faults	Demands placed on electrical devices from standards and laws Minimum requirements - Glow wire test in accordance with IEC 60695-2-11: - 650°C for boxes and cable glands - 850°C for parts of insulating material necessary to retain current carrying parts in position
Burning behaviour	Glow wire test IEC 60695-2-11: 960 °C UL Subject 94: V-2 flame-retardant self-extinguishing
Degree of protection against mechanical load	IK08 (5 Joule)
Toxic behaviour	halogen-free silicone-free "halogen-free" in accordance with the examination of the cables and insulated wires - corrosiveness of fumes - as per IEC 60754-2
Note:	Supplementing references regarding outdoor installation - harsh environment and / or outdoor: - The materials used for the Mi System are basically UV resistant, so that the mechanical resistance of the boxes is maintained during UV effect. Depending on the intensity of the UV effect e.g. transparent lids can become intransparent. - The top side of the boxes should be protected by a cover against weather influences such as rains, ice and snow. - Further on, also chemical influences have to be considered with the selection of the installation place - apart from the IP rating and climatic effects. - In order to keep the maximum permissible

Empty boxes

	Mi 0210		
	<ul style="list-style-type: none">• Built-in dimensions W 275 x H 275 x D 195 mm		

ambient temperature of the installed equipment as well as for the prevention from condensation additional measures as ventilation and/or heating may be necessary.
For material properties see technical data.