

LOVATO ELECTRIC S.P.A.

24020 GORLE (BERGAMO) ITALIA  
VIA DON E. MAZZA, 12  
TEL. 035 4282111  
TELEFAX (Nazionale): 035 4282200  
TELEFAX (International): +39 035 4282400  
E-mail info@LovatoElectric.com  
Web www.LovatoElectric.com



- I** Blocchi aggiuntivi e accessori per interruttori sezionatori serie GA
- GB** Add-on blocks and accessories for switch disconnectors GA series
- D** Anbaublöcke und zubehör für Trennschalter serie GA
- F** Blocs additifs et accessoires pour interrupteurs-sectionneurs serie GA
- E** Bloques adicionales y accesorios para interruptores seccionadores serie GA

**WARNING!**

- This equipment is to be installed by qualified personnel, complying to current standards, to avoid damages or safety hazards.
- The manufacturer cannot be held responsible for electrical safety in case of improper use of the equipment.
- Products illustrated herein are subject to alteration and changes without prior notice. Technical data and descriptions in the documentation are accurate, to the best of our knowledge, but no liabilities for errors, omissions or contingencies arising there from are accepted.

**ATTENZIONE!**

- Questi apparecchi devono essere installati da personale qualificato, nel rispetto delle vigenti normative impiantistiche, allo scopo di evitare danni a persone o cose.
- Il costruttore non si assume responsabilità in merito alla sicurezza elettrica in caso di utilizzo improprio del dispositivo.
- I prodotti descritti in questo documento sono suscettibili in qualsiasi momento di evoluzioni o di modifiche. Le descrizioni ed i dati a catalogo non possono pertanto avere alcun valore contrattuale.

**ATTENTION !**

- Ces appareils doivent être installés par un personnel qualifié, conformément aux normes en vigueur en matière d'installations, afin d'éviter de causer des dommages à des personnes ou choses.
- Le constructeur n'assume aucune responsabilité quant à la sécurité électrique en cas d'utilisation impropre du dispositif.
- Les produits décrits dans ce document sont susceptibles d'évoluer ou de subir des modifications à n'importe quel moment. Les descriptions et caractéristiques techniques du catalogue ne peuvent donc avoir aucune valeur contractuelle.

**UWAGA!**

- W celu uniknięcia obrażeń osób lub uszkodzenia mienia tego typu urządzenia muszą być instalowane przez wykwalifikowany personel, zgodnie z obowiązującymi przepisami.
- Producent nie przyjmuje na siebie odpowiedzialności za bezpieczeństwo elektryczne w przypadku niewłaściwego użytkowania urządzenia.
- Produkty opisane w niniejszym dokumencie mogą być w każdej chwili udoskonalone lub zmodyfikowane. Opisy oraz dane katalogowe nie mogą mieć w związku z tym żadnej wartości umownej.

**ACHTUNG!**

- Zur Vermeidung von Personen- und Sachschäden dürfen diese Geräte nur von qualifiziertem Fachpersonal und unter Befolgung der einschlägigen Vorschriften installiert werden.
- Bei zweckwidrigem Gebrauch der Vorrichtung übernimmt der Hersteller keine Haftung für die elektrische Sicherheit.
- Die in dieser Broschüre beschriebenen Produkte können jederzeit weiterentwickelt und geändert werden. Die im Katalog enthaltenen Beschreibungen und Daten sind daher unverbindlich und ohne Gewähr.

**警告!**

- 本设备只能由合格人员根据现行标准进行安装，以避免造成损坏或安全危害。
- 制造商不负责因设备使用不当导致的电气安全问题。
- 此处说明的产品可能会有变更，恕不提前通知。我们竭力确保本档中技术数据和说明的准确性，但对于错误、遗漏或由此产生的意外事件概不负责。

**ADVERTENCIA**

- Este dispositivo debe ser instalado por personal cualificado conforme a la normativa de instalación vigente a fin de evitar daños personales o materiales.
- El fabricante no se responsabilizará de la seguridad eléctrica en caso de que el dispositivo no se utilice de forma adecuada.
- Los productos descritos en este documento se pueden actualizar o modificar en cualquier momento. Por consiguiente, las descripciones y los datos técnicos aquí contenidos no tienen valor contractual.

**ПРЕДУПРЕЖДЕНИЕ!**

- Во избежание травм или материального ущерба монтаж должен осуществляться только квалифицированным персоналом в соответствии с действующими нормативами.
- Производитель не несет ответственность за обеспечение электробезопасности в случае ненадлежащего использования устройства.
- Изделия, описанные в настоящем документе, в любой момент могут подвергнуться изменениям или усовершенствованиям. Поэтому каталожные данные и описания не могут рассматриваться как действительные с точки зрения контрактов

**UPOZORNĚNÍ**

- Tato zařízení smí instalovat kvalifikovaní pracovníci v souladu s platnými předpisy a normami pro předcházení úrazů osob či poškození věcí.
- Výrobce nenese odpovědnost za elektrickou bezpečnost v případě nevhodného používání regulátoru.
- Výrobky popsané v tomto dokumentu mohou kdykoli projít úpravami či dalším vývojem. Popisy a údaje uvedené v katalogu nemají proto žádnou smluvní hodnotu.

**DİKKAT!**

- Bu aparatlar kişilere veya nesnelere zarar verme ihtimaline karşı yürürlükte olan sistem kurma normlarına göre kalifiye personel tarafından monte edilmelidirler
- Üretici aparatın hatalı kullanımından kaynaklanan elektriksel güvenliğe ait sorumluluk kabul etmez.
- Bu dokümanda tarif edilen ürünler her an evrimlere veya değişimlere açıktır. Bu sebeple katalogdaki tarif ve değerler herhangi bir bağlayıcı değeri haiz değildir.

**AVERTIZARE!**

- Acest echipament va fi instalat de personal calificat, în conformitate cu standardele actuale, pentru a evita deteriorări sau pericolele.
- Producătorul nu poate fi considerat responsabil pentru siguranța electrică în caz de utilizare incorectă a echipamentului.
- Produsele ilustrate în prezentul sunt supuse modificărilor și schimbărilor fără notificare anterioară. Datele tehnice și descrierile din documentație sunt precise, în măsura cunoștințelor noastre, dar nu se acceptă nicio răspundere pentru erorile, omisiunile sau evenimentele neprevăzute care apar ca urmare a acestora.



GA016A...GA040A - GA063SA

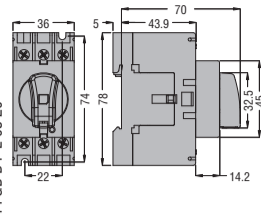

GA030A  
GA063A...GA160A

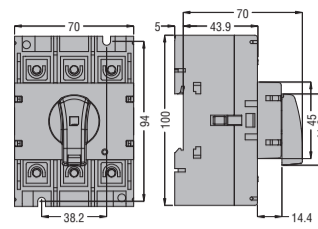

GAX1011A - GAX1110EA

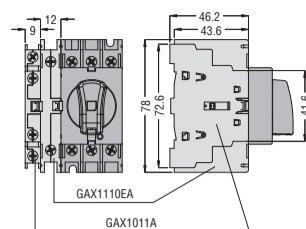

GAX41040A - GAX42040A  
GAX41063SA - GAX42063SA  
GAX31A - GAX33A

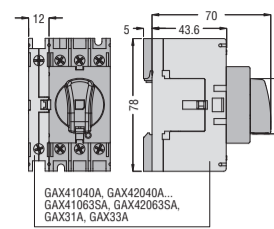

GAX1011A - GAX1210EA

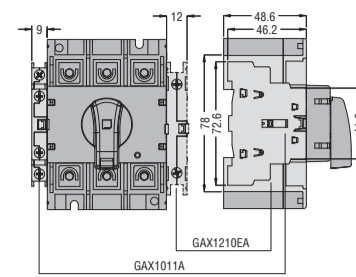

GAX41125A  
GAX42063A...GAX42160A  
GAX32A - GAX34A

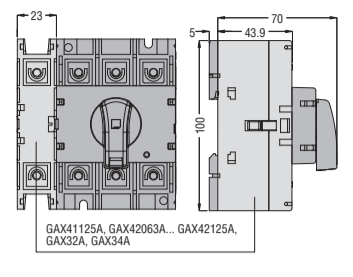

GA016C...GA040C

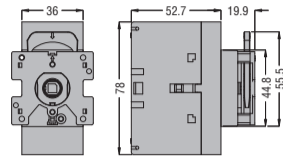

GA030C  
GA063C...GA125C

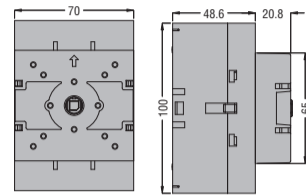

GAX1011C

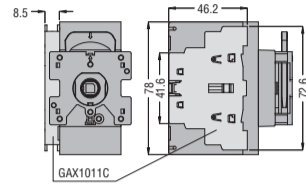

GAX41040C - GAX42040C  
GAX31C - GAX33C

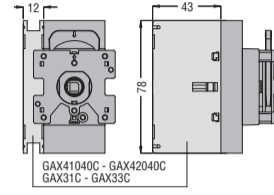

GAX1011C

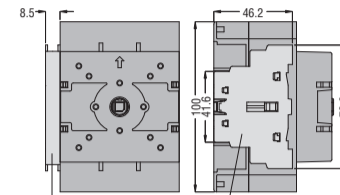

GAX41125C - GAX42063C...GAX42125C  
GAX32C - GAX34C

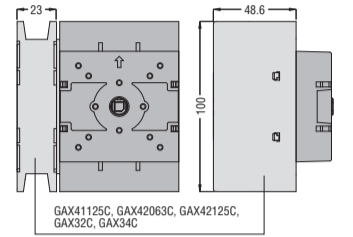

GAX81 - GAX83

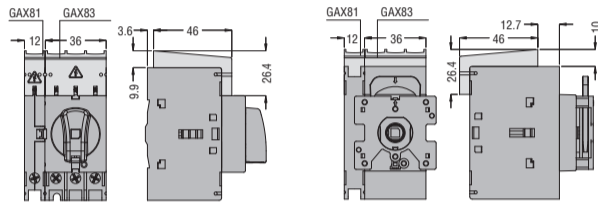

GAX82 - GAX84

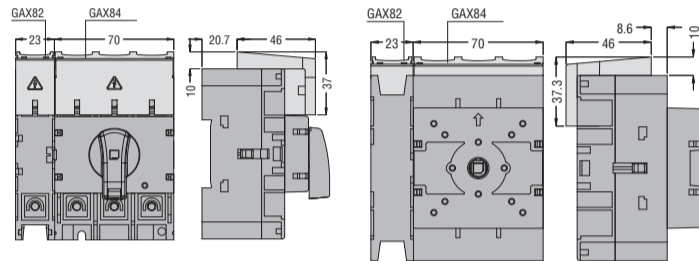

GAX391 - GAX391UL

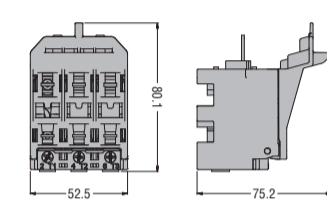

UL Marking for GAX391UL:  
For use only with GA016A and GA025A.  
Use only max. 30A Class CC fuses.

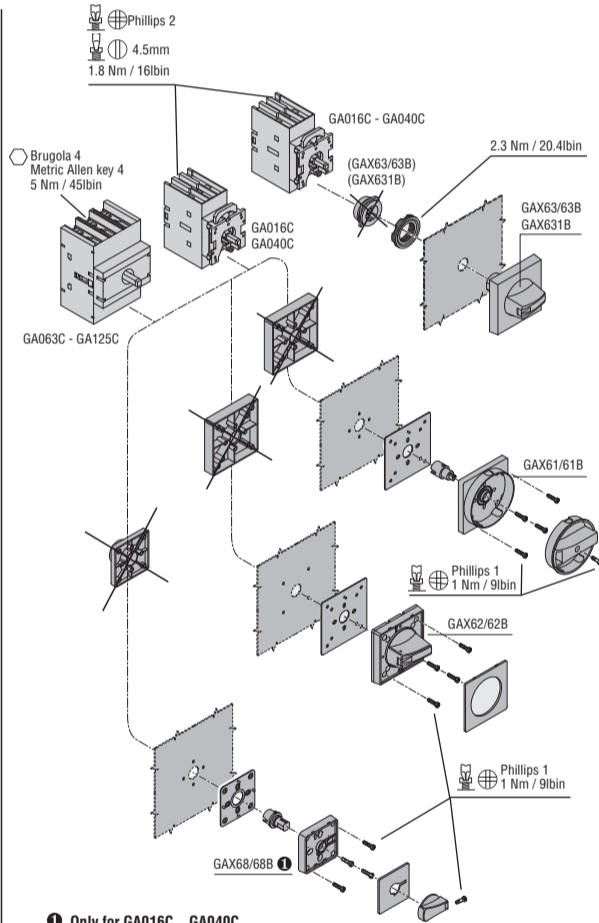
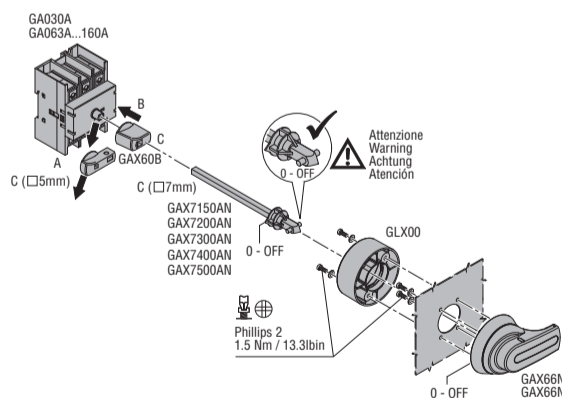
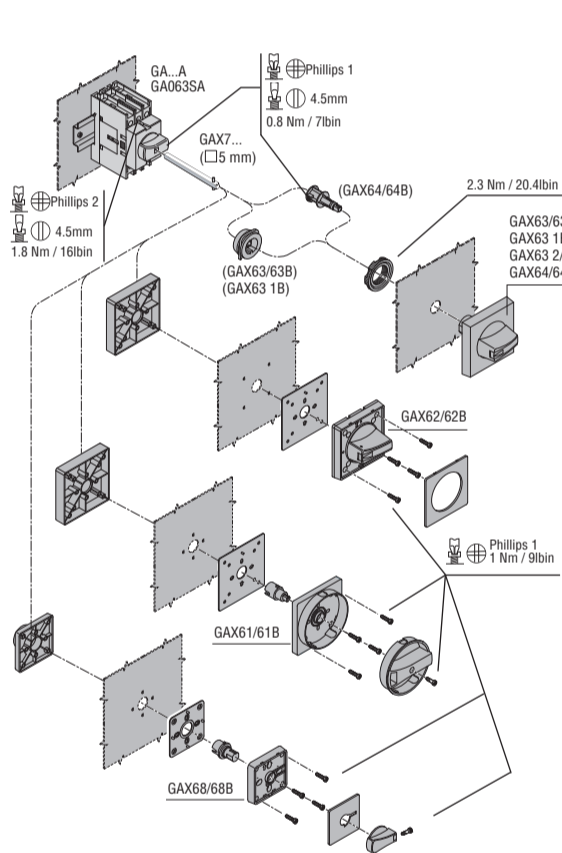

1 Only for GA016C...GA040C.

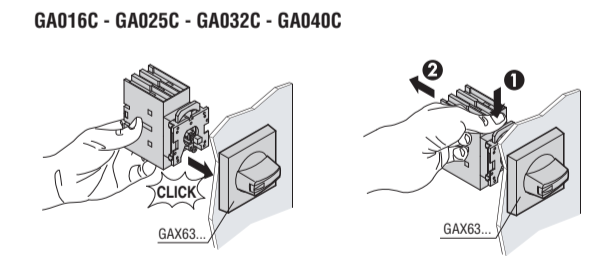

GAX61/61B

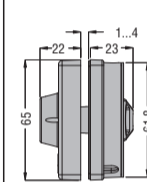

GAX62/62B

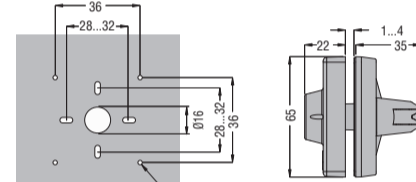

GAX63/63B  
GAX631B

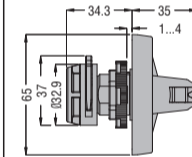

GAX632/2B

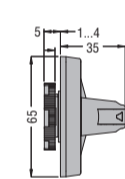

GAX64/64B

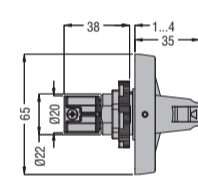

GAX66N/66NB

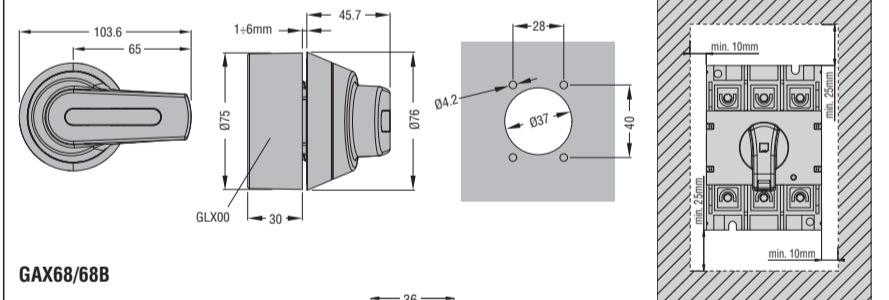

GAX68/68B

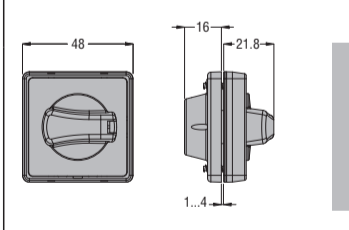

UL Marking

- GA030... GA063... GA080... GA100... GA125... minimum enclosure size HxWxD: 150x140x110mm.  
- GAX61, GAX66 for use on a flat surface, type 1, 4 and 4X outdoor use. (for all GA types)  
- GAX62, GAX63, GAX63 2, GAX68 or GAX64 for use on a flat surface, type 1, 2, 3R, 12, 12K, 4 and 4X outdoor use when used with GA016A/C-GA040A/C and GA063SA, otherwise type 1 only.

GAX7... - GAX6...

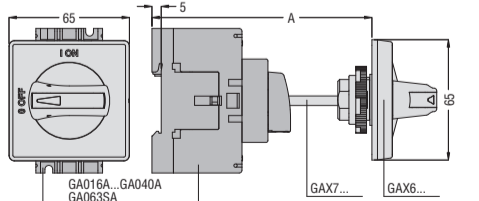

GAX7...	B [mm]	A [mm] max				
		GAX61...	GAX62...	GAX63...	GAX64... GAX68...	
GAX7055	55	99	97	102	116	98.5
GAX7070	70	114	112	117	131	113.5
GAX7090	90	134	132	137	151	133.5
GAX7150	150	194	192	197	211	193.5
GAX7200	200	244	242	247	261	243.5
GAX7300	300	344	342	347	361	343.5
GAX7400	400	444	442	447	461	443.5
GAX7500	500	544	542	547	561	543.5

GA016A...GA040A - GA063SA

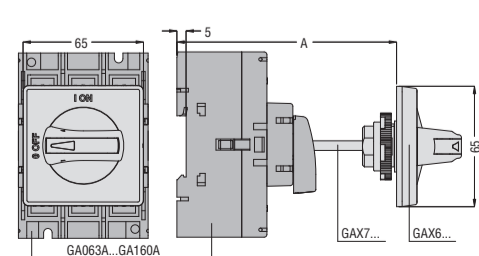

GA030A - GA063A...GA160A

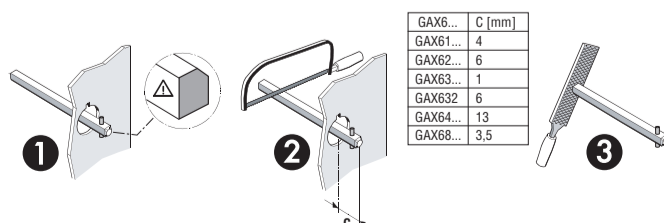

GAX7...A - GAX66N/66NB - GAX60B

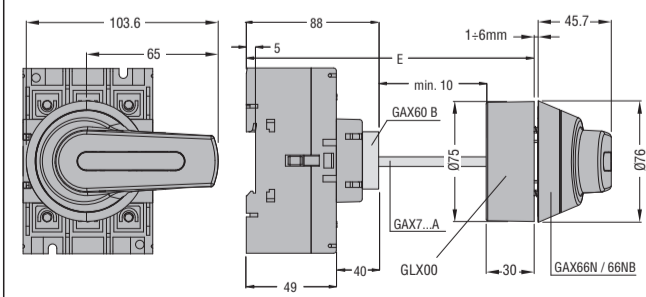

GA030A  
GA063A...GA160A

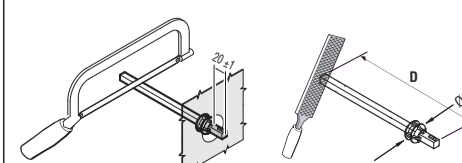

GAX7...AN	D		E
	[mm]	GAX66N/66NB [mm]	
GAX7150AN	176	118..229	
GAX7200AN	226	118..279	
GAX7300AN	326	118..379	
GAX7400AN	426	118..479	
GAX7500AN	526	118..579	