

# FLEX I/O Digital Input and Output Modules

Catalog Numbers 1794-IB10X0B6, 1794-IB16X0B16P

<b>Topic</b>	<b>Page</b>
Important User Information	2
Environment and Enclosure	3
North American Hazardous Location Approval	4
European Hazardous Location Approval	5
Prevent Electrostatic Discharge	6
Installing Your Digital Input/output Module	8
Configuring Your Module	15
Specifications	18
Derating Curve for 1794-IB16X0B16P	23

## Important User Information

Solid-state equipment has operational characteristics differing from those of electromechanical equipment. Safety Guidelines for the Application, Installation and Maintenance of Solid-state Controls (Publication [SGI-1.1](#) available from your local Rockwell Automation sales office or online at <http://www.rockwellautomation.com/literature/>) describes some important differences between solid-state equipment and hard-wired electromechanical devices. Because of this difference, and also because of the wide variety of uses for solid-state equipment, all persons responsible for applying this equipment must satisfy themselves that each intended application of this equipment is acceptable.

In no event will Rockwell Automation, Inc. be responsible or liable for indirect or consequential damages resulting from the use or application of this equipment.

The examples and diagrams in this manual are included solely for illustrative purposes. Because of the many variables and requirements that are associated with any particular installation, Rockwell Automation, Inc. cannot assume responsibility or liability for actual use based on the examples and diagrams.

No patent liability is assumed by Rockwell Automation, Inc. with respect to use of information, circuits, equipment, or software described in this manual.

Reproduction of the contents of this manual, in whole or in part, without written permission of Rockwell Automation, Inc., is prohibited.

Throughout this manual, when necessary, we use notes to make you aware of safety considerations.

	<b>WARNING:</b> Identifies information about practices or circumstances that can cause an explosion in a hazardous environment, which may lead to personal injury or death, property damage, or economic loss.
	<b>ATTENTION:</b> Identifies information about practices or circumstances that can lead to personal injury or death, property damage, or economic loss. Attentions help you identify a hazard, avoid a hazard and recognize the consequences.
	<b>SHOCK HAZARD:</b> Labels may be on or inside the equipment (for example, drive or motor) to alert people that dangerous voltage may be present.
	<b>BURN HAZARD:</b> Labels may be on or inside the equipment (for example, drive or motor) to alert people that surfaces may reach dangerous temperatures.
<b>IMPORTANT</b>	Identifies information that is critical for successful application and understanding of the product.

---

## Environment and Enclosure

---



**ATTENTION:** This equipment is intended for use in a Pollution Degree 2 industrial environment, in overvoltage Category II applications (as defined in EN/IEC 60664-1), at altitudes up to 2000 m (6562 ft) without derating.

This equipment is not intended for use in residential environments and may not provide adequate protection to radio communication services in such environments.

This equipment is supplied as open-type equipment for indoor use. It must be mounted within an enclosure that is suitably designed for those specific environmental conditions that will be present and appropriately designed to prevent personal injury resulting from accessibility to live parts. The enclosure must have suitable flame-retardant properties to prevent or minimize the spread of flame, complying with a flame spread rating of 5V A or be approved for the application if nonmetallic. The interior of the enclosure must be accessible only by the use of a tool. Subsequent sections of this publication may contain more information regarding specific enclosure type ratings that are required to comply with certain product safety certifications.

In addition to this publication, see the following:

- Industrial Automation Wiring and Grounding Guidelines, publication [1770-4.1](#), for additional installation requirements.
- NEMA Standard 250 and EN/IEC 60529, as applicable, for explanations of the degrees of protection provided by enclosures.





**ATTENTION:** Read this document and the documents listed in the Additional Resources section about installation, configuration, and operation of this equipment before you install, configure, operate, or maintain this product. Users are required to familiarize themselves with installation and wiring instructions in addition to requirements of all applicable codes, laws, and standards.

Installation, adjustments, putting into service, use, assembly, disassembly, and maintenance are required to be carried out by suitably trained personnel in accordance with applicable code of practice. In case of malfunction or damage, no attempts at repair should be made. The module should be returned to the manufacturer for repair. Do not dismantle the module.

## North American Hazardous Location Approval

The following modules are North American Hazardous Location approved:  
1794-IB10XOB6, 1794-IB16XOB16P

The Following Information Applies When Operating This Equipment In Hazardous Locations.	Informations sur l'utilisation de cet équipement en environnements dangereux.
<p>Products marked "CL I, DIV 2, GP A, B, C, D" are suitable for use in Class I Division 2 Groups A, B, C, D, Hazardous Locations and nonhazardous locations only. Each product is supplied with markings on the rating nameplate indicating the hazardous location temperature code. When combining products within a system, the most adverse temperature code (lowest "T" number) may be used to help determine the overall temperature code of the system. Combinations of equipment in your system are subject to investigation by the local Authority Having Jurisdiction at the time of installation.</p>	<p>Les produits marqués "CL I, DIV 2, GP A, B, C, D" ne conviennent qu'à une utilisation en environnements de Classe I Division 2 Groupes A, B, C, D dangereux et non dangereux. Chaque produit est livré avec des marquages sur sa plaque d'identification qui indiquent le code de température pour les environnements dangereux. Lorsque plusieurs produits sont combinés dans un système, le code de température le plus défavorable (code de température le plus faible) peut être utilisé pour déterminer le code de température global du système. Les combinaisons d'équipements dans le système sont sujettes à inspection par les autorités locales qualifiées au moment de l'installation.</p>
<div style="display: flex; align-items: center;">  <div> <p><b>WARNING:</b> <b>Explosion Hazard –</b></p> <ul style="list-style-type: none"> <li>• Do not disconnect equipment unless power has been removed or the area is known to be nonhazardous.</li> <li>• Do not disconnect connections to this equipment unless power has been removed or the area is known to be nonhazardous. Secure any external connections that mate to this equipment by using screws, sliding latches, threaded connectors, or other means provided with this product.</li> <li>• Substitution of components may impair suitability for Class I, Division 2.</li> </ul> </div> </div>	<div style="display: flex; align-items: center;">  <div> <p><b>AVERTISSEMENT:</b> <b>Risque d'Explosion –</b></p> <ul style="list-style-type: none"> <li>• Couper le courant ou s'assurer que l'environnement est classé non dangereux avant de débrancher l'équipement.</li> <li>• Couper le courant ou s'assurer que l'environnement est classé non dangereux avant de débrancher les connecteurs. Fixer tous les connecteurs externes reliés à cet équipement à l'aide de vis, loquets coulissants, connecteurs filetés ou autres moyens fournis avec ce produit.</li> <li>• La substitution de composants peut rendre cet équipement inadapté à une utilisation en environnement de Classe I, Division 2.</li> </ul> </div> </div>



**WARNING:** When used in a Class I, Division 2, hazardous location, this equipment must be mounted in a suitable enclosure with proper wiring method that complies with the governing electrical codes.

## European Hazardous Location Approval

The following module is European Zone 2 approved: 1794-IB10XOB6.

### The following applies to products marked **CE** **II 3 G:**

- Are intended for use in potentially explosive atmospheres as defined by European Union Directive 2014/34/EU and has been found to comply with the Essential Health and Safety Requirements relating to the design and construction of Category 3 equipment intended for use in Zone 2 potentially explosive atmospheres, given in Annex II to this Directive.
- Compliance with the Essential Health and Safety Requirements has been assured by compliance with EN 60079-15 and EN 60079-0.
- Are Equipment Group II, Equipment Category 3, and comply with the Essential Health and Safety Requirements relating to the design and construction of such equipment given in Annex II to Directive 2014/34/EU. See the EC Declaration of Conformity at <http://www.rockwellautomation.com/global/certification/overview.page> for details.
- The type of protection is Ex nA IIC T3 Gc according to EN 60079-15.
- Comply to Standards EN 60079-0:2012, EN 60079-15:2010, reference certificate number DEMKO 14 ATEX 1342501X.
- Are intended for use in areas in which explosive atmospheres caused by gases, vapors, mists, or air are unlikely to occur, or are likely to occur only infrequently and for short periods. Such locations correspond to Zone 2 classification according to ATEX directive 2014/34/EU.



### WARNING:

- This equipment is not resistant to sunlight or other sources of UV radiation.
- This equipment shall be used within its specified ratings defined by Rockwell Automation.
- Provision shall be made to prevent the rated voltage from being exceeded by transient disturbances of more than 140% of the peak rated voltage when applied in Zone 2 environments.
- The instructions in the user manual shall be observed.
- This equipment must be used only with ATEX certified Rockwell Automation backplanes.
- Earthing is accomplished through mounting of modules on rail.
- Devices shall be used in an environment of not more than Pollution Degree 2.

## Prevent Electrostatic Discharge

---



**ATTENTION:** This equipment is sensitive to electrostatic discharge, which can cause internal damage and affect normal operation. Follow these guidelines when you handle this equipment:

- Touch a grounded object to discharge potential static.
  - Wear an approved grounding wriststrap.
  - Do not touch connectors or pins on component boards.
  - Do not touch circuit components inside the equipment.
  - Use a static-safe workstation, if available.
  - Store the equipment in appropriate static-safe packaging when not in use.
- 

## Special Conditions for Safe Use

---



**ATTENTION:**

- This product is grounded through the DIN rail to chassis ground. Use zinc plated chromate-passivated steel DIN rail to assure proper grounding. The use of other DIN rail materials (for example, aluminum or plastic) that can corrode, oxidize, or are poor conductors, can result in improper or intermittent grounding. Secure DIN rail to mounting surface approximately every 200 mm (7.8 in.) and use end-anchors appropriately. Be sure to ground the DIN rail properly. Refer to Industrial Automation Wiring and Grounding Guidelines, publication [1770-4.1](#), for more information.
  - Do not remove or replace an Adapter Module while power is applied. Interruption of the backplane can result in unintentional operation or machine motion.
  - Do not remove or replace a terminal base unit while power is applied. Interruption of the backplane can result in unintentional operation or machine motion.
  - If this equipment is used in a manner not specified by the manufacturer, the protection provided by the equipment may be impaired.
-

**WARNING:**

- When you insert or remove the module while backplane power is on, an electric arc can occur. This could cause an explosion in hazardous location installations.  
Be sure that power is removed or the area is nonhazardous before proceeding. Repeated electric arcing causes excessive wear to contacts on both the module and its mating connector. Worn contacts may create electrical resistance that can affect module operation.
  - If you insert or remove the module while backplane power is on, an electric arc can occur. This could cause an explosion in hazardous location installations.  
Be sure that power is removed or the area is nonhazardous before proceeding.
- 



**WARNING:** If you connect or disconnect wiring while the field-side power is on, an electrical arc can occur. This could cause an explosion in hazardous location installations. Be sure that power is removed or the area is nonhazardous before proceeding.

---

## Electrical Safety Considerations

---

**ATTENTION:**

- This equipment is certified for use only within the surrounding air temperature range of 0...55 °C (32...131 °F). The equipment must not be used outside of this range.
  - Use only a soft dry anti-static cloth to wipe down equipment. Do not use any cleaning agents.
- 



At the end of its life, this equipment should be collected separately from any unsorted municipal waste.

---

## Installing Your Digital Input/output Module

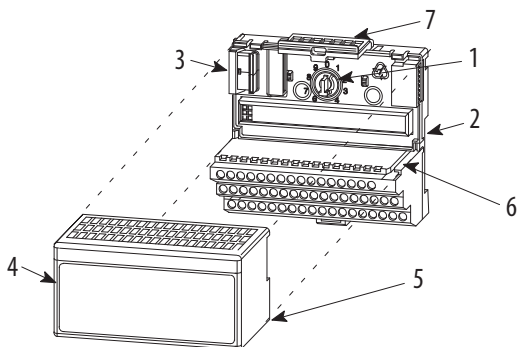

	Description		Description
1	Keyswitch	5	Alignment bar
2	Terminal base	6	Groove
3	Flexbus connector	7	Latching mechanism
4	Module		

The 1794-IB10XOB6 module mounts on a 1794-TB3 or 1794-TB3S terminal base. The 1794-IB16XOB16P module mounts on a 1794-TB32 or 1794-TB32S terminal base.



**ATTENTION:** During mounting of all devices, be sure that all debris (metal chips, wire strands, etc.) is kept from falling into the module. Debris that falls into the module could cause damage on power up.

1. Rotate the keyswitch (1) on the terminal base (2) clockwise to position 2 as required for this type of module.
2. Ensure that the Flexbus connector (3) is pushed all the way to the left to connect with the neighboring terminal base/adaptor. **You cannot install the module unless the connector is fully extended.**



3. Make sure the pins on the bottom of the module are straight so they will align properly with the connector in the terminal base.



**WARNING:** If you insert or remove the module while backplane power is on, an electrical arc can occur. This could cause an explosion in hazardous location installations. Be sure that power is removed or the area is nonhazardous before proceeding.

4. Position the module (4) with its alignment bar (5) aligned with the groove (6) on the terminal base.
5. Press firmly and evenly to seat the module in the terminal base unit. The module is seated when the latching mechanism (7) is locked into the module.

### Connecting Wiring for the 1794-IB10XOB6

1. Connect individual input and output wiring to numbered terminals on the 0...15 row (A) as indicated in the [Wiring Connections for 1794-IB10XOB6](#) table.
2. Connect the associated +V DC power lead of the input device to the corresponding terminal on the 34...51 row (C) for each input as indicated in the [Wiring Connections for 1794-IB10XOB6](#) table. (The +V power terminals of row (C) are internally connected together.)
3. Connect the associated input device common (3-wire devices only) and output device common to the corresponding terminals on the 16...33 row. (B) for each input and output as indicated in the [Wiring Connections for 1794-IB10XOB6](#) table. (Commons are internally connected together.)
4. Connect +V DC power to terminal 34 on the 34...51 row (C).
5. Connect V DC common to terminal 16 on the 16...33 row (B).
6. If daisy chaining power to the next terminal base, connect a jumper from terminal 51 (+V DC) on this base unit to terminal 34 on the next base unit.

7. If continuing DC common to the next base unit, connect a jumper from terminal 33 (240V common L2) on this base unit to terminal 16 on the next base unit.

### Wiring Connections for 1794-IB10X0B6

Input <sup>(1)</sup>	Signal	Return	Supply
Sink input			
Input 0	A-0	B-17	C-35
Input 1	A-1	B-18	C-36
Input 2	A-2	B-19	C-37
Input 3	A-3	B-20	C-38
Input 4	A4	B-21	C-39
Input 5	A-5	B-22	C-40
Input 6	A-6	B-23	C-41
Input 7	A-7	B-24	C-42
Input 8	A-8	B-25	C-43
Input 9	A-9	B-27	C-44
Source output			
Input 10	A-10	B-27	
Input 11	A-11	B-28	
Input 12	A-12	B-29	
Input 13	A-13	B-30	
Input 14	A-14	B-31	
Input 15	A-15	B-32	
+V DC	C-34 to C-51 (internally connected together)		
Common	B-16 to B-33 (internally connected together)		

(1) 2-wire input devices use signal and supply terminals; 3-wire devices use signal, return, and supply terminal

### 1794-TB3 and 1794-TB3S Terminal Base Wiring for 1794-IB10XOB6

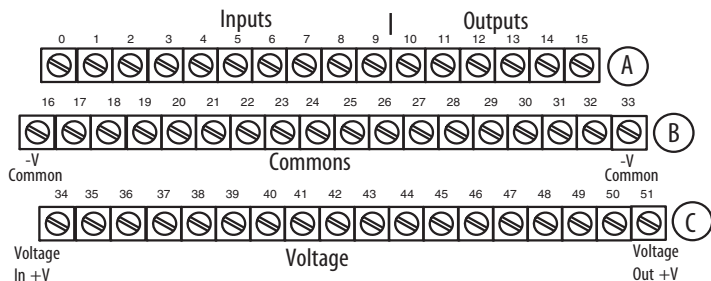

-V (Supply Common) = Terminals B-16 and B-33

(1794-TB3 shown)

+V (Supply +Voltage In) = Terminals C-34 and C-51

(Use B-33 and C-51 for daisy-chaining to next terminal base unit)

### 2 and 3-Wire Input Wiring for 1794-IB10XOB6

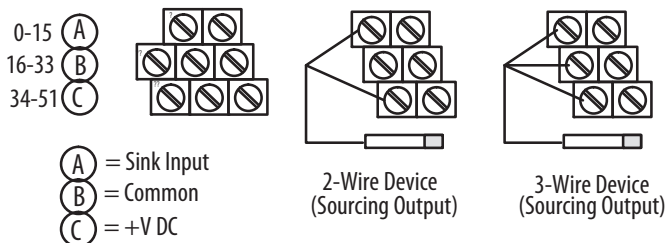

### Connecting Wiring for the 1794-IB16XOB16P

1. Connect individual input wiring (IN0 to IN15) to numbered terminals on the 0...15 row (A) as indicated in the [Wiring Connections for 1794-IB16XOB16P](#) table.
2. Connect the associated power to the +V1 terminal (35, 37, 39 or 41) on the 34...51 row (C) as indicated in the [Wiring Connections for 1794-IB16XOB16P](#) table.

3. Connect the associated common (-V1) for IN0 to IN15 to COM1 (terminal 36, 38, 40 or 42) on the 34...51 row (C).
4. Connect individual output wiring (OUT0 to OUT15) to terminals 17 to 32 on the 16...33 row (B) as indicated in the [Wiring Connections for 1794-IB16XOB16P](#) table. (**Note:** Do not connect to terminals 16 or 33.)
5. Connect the associated power to the +V2 terminal (43, 45, 47 or 49) on the 34...51 row (C) as indicated in the [Wiring Connections for 1794-IB16XOB16P](#) table.
6. Connect the associated common (-V2) for OUT0 to OUT15 to COM2 (terminal 44, 46, 48 or 50) on the 34...51 row (C).
7. If continuing input wiring to the next terminal base unit, connect a jumper from terminal 41 (+V1) to the power terminal on the next base unit; connect a jumper from terminal 42 (COM1) to the common terminal on the next base unit.
8. If continuing output wiring to the next terminal base unit, connect a jumper from terminal 49 (+V2) to the power terminal on the next base unit; connect a jumper from terminal 50 (COM2) to the common terminal on the next base unit.

**Wiring Connections for 1794-IB16XOB16P**

<b>Input</b>	<b>Signal</b>	<b>Return</b>	<b>Supply<sup>(1)</sup></b>
Input 0	A-0	V1 Return connected to terminals 36, 38, 40, and 42	+V1 connected to terminals 35, 37, 39, and 41
Input 1	A-1		
Input 2	A-2		
Input 3	A-3		
Input 4	A4		
Input 5	A-5		
Input 6	A-6		
Input 7	A-7		
Input 8	A-8		
Input 9	A-9		
Input 10	A-10		
Input 11	A-11		
Input 12	A-12		
Input 13	A-13		
Input 14	A-14		
Input 15	A-15		

**Wiring Connections for 1794-IB16XOB16P**

Input	Signal	Return	Supply <sup>(1)</sup>
Output 0	B-17	V2 Return connected to terminals 44, 46, 48, and 50	+V2 connected to terminals 43, 45, 47, and 49
Output 1	B-18		
Output 2	B-19		
Output 3	B-20		
Output 4	B-21		
Output 5	B-22		
Output 6	B-23		
Output 7	B-24		
Output 8	B-25		
Output 9	B-27		
Output 10	B-27		
Output 11	B-28		
Output 12	B-29		
Output 13	B-30		
Output 14	B-31		
Output 15	B-32		
+V1 DC power	Power terminals 35, 37, 39, and 41		
Com1 DC return	Common terminals 36, 38, 40, and 42		
+V2 DC power	Power terminals 43, 45, 47, and 49		
Com2 DC return	Common terminals 44, 46, 48, and 50		

(1) 2-wire input devices use signal and supply terminals; 3-wire devices use signal, return, and supply terminal

### 1794-TB32 Terminal Base Wiring for 1794-IB16XOB16P

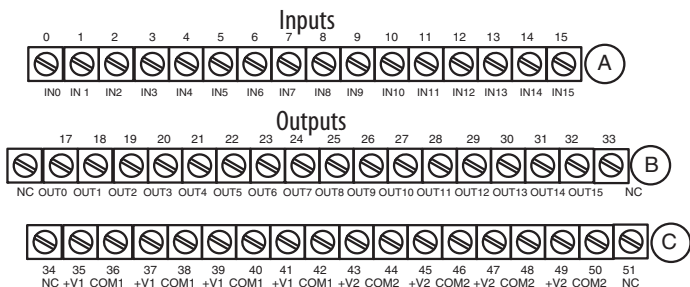

+V1 = Terminals 35, 37, 39 and 41

(1794-TB32 shown)

+V2 = Terminals 43, 45, 47 and 49

COM1 = Terminals 36, 38, 40 and 42

COM2 = Terminals 44, 46, 48 and 50

NC = No connections (terminals 16, 33, 34 and 51)

## Configuring Your Module

You configure your module by setting bits in the configuration word (word 3).

### Image Table Memory Map for the 1794-IB10XOB6 Module

Dec	15	14	13	12	11	10	9	8	7	6	5	4	3	2	1	0
Oct	17	16	15	14	13	12	11	10	7	6	5	4	3	2	1	0
Read 1	Not used						19	18	17	16	15	14	13	12	11	10
Write 2	Not used										05	04	03	02	01	00
Write 3	Not used					FT			Not used							

Where I = Input  
 O = Output  
 FT = Input filter time for input channels

### Image Table Memory Map for the 1794-IB16XOB16P Module

Dec	15	14	13	12	11	10	9	8	7	6	5	4	3	2	1	0
Oct	17	16	15	14	13	12	11	10	7	6	5	4	3	2	1	0
Read 1	I15	I14	I13	I12	I11	I10	I9	I8	I7	I6	I5	I4	I3	I2	I1	I0
Write 2	O15	O14	O13	O12	O11	O10	O9	O8	O7	O6	O5	O4	O3	O2	O1	O0
Write 3	Not used													Input filter FT 0...15		

Where I = Input  
 O = Output  
 FT = Input filter time for all 16 inputs (0...15)

### Setting the Input Filter Time

To set the input filter time, set the associated bits in the output image (complementary word) for the module.

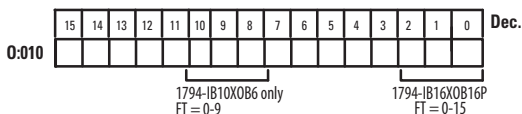

For example, to increase the off-to-on filter time to 8 ms for all inputs at address rack 1, module group 0, in configuration word 3, set bits as shown below.

Write filter time on system startup.

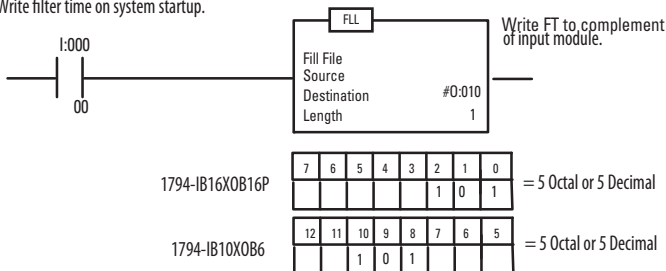

Filter times are shown in the [Input Filter Times](#) table.



## Input Filter Times

Bits <sup>(1)</sup>			Description	
02	01	00	Filter Time for Inputs	Off to On/On to Off
10	09	03		
0	0	0	Filter time 0 (default)	0.25 ms
0	0	1	Filter time 1	0.5 ms
0	1	0	Filter time 2	1.0 ms
0	1	1	Filter time 3	2.0 ms
1	0	1	Filter time 4	4.0 ms
1	0	1	Filter time 5	8.0 ms
1	1	0	Filter time 6	16.0 ms
1	1	1	Filter time 7	32.0 ms

(1) Use bits 00, 01, and 02 for 1794-IB16X0B16P; use bits 08, 09, and 10 for 1794-IB10X0B6.

## Specifications

### Specifications

Attribute	1794-IB10X0B6	1794-IB16X0B16P
Number of inputs	10, current, sinking	16, current, sinking
Number of outputs	6, current, sourcing	16, current, sourcing
Recommended terminal base unit	1794-TB2, 1794-TB3, 1794-TB3S, 1794-TB3K, 1794-TB3SK, 1794-TBKD, 1794-TB37DS	1794-TB32, 1794-TB32S, 1794-TB62DS, 1794-TB62EXD4X15
On-state voltage, input, min	10V DC	
On-state voltage, input, nom	24V DC	
On-state voltage, input, max	31.2V DC	
On-state current, input, min	2.0 mA	
On-state current, input, nom	8.0 mA @ 24V DC	8.8 mA @ 24V DC
On-state current, input, max	11.0 mA	12.1 mA
Off-state voltage, input, max	5V DC	
Off-state current, input, max	1.5 mA	
Nominal input impedance	4.8 kΩ	2.5 kΩ
Input filter time <sup>(1)</sup> Off to On On to Off	See <a href="#">Input Filter Times</a> table	
On-state voltage range, output, min	10V DC	
On-state voltage range, output, nom	24V DC	
On-state voltage range, output, max	31.2V DC	31.2V DC (see <a href="#">Derating Curve for 1794-IB16X0B16P</a> )
On-state current, output, min	1.0 mA per channel	
On-state current, output, max	2.0 A per channel 10 A per module	0.5 A per channel 8 A per module
Off-state voltage, output, max	31.2V DC	
Output current rating	2 A per output 10 A per module, max	0.5 A per output 8 A per module, max
Surge current	4 A for 50 ms, repeatable every 2 s	1.5 A for 50 ms, repeatable every 2 s

## Specifications

Attribute	1794-IB10X0B6	1794-IB16X0B16P
Off-state leakage current, max	0.5 mA	
On-state voltage drop, max	1V DC @ 2 A 0.5V DC @ 1 A	0.5V DC @ 1 A
Output signal delay, max <sup>(2)</sup> Off to On On to Off	0.5 ms 1.0 ms	
Isolation voltage	50V (continuous), Basic Insulation Type Type tested @ 1250V AC for 60 s, between field side and system No isolation between individual channels	50V (continuous), Basic Insulation Type Tested @ 2121V DC for 1 s, system to I/O and inputs to outputs No isolation between individual channels
Flexbus current	50 mA	80 mA
Power dissipation, max	6.0 W @ 31.2V DC	7.0 W @ 31.2V DC
Thermal dissipation, max	20.3 BTU/hr @ 31.2V DC	23.9 BTU/hr @ 31.2V DC
Fusing	Module outputs are not fused. Fusing is recommended. If fusing is desired, you must supply external fusing. Use SAN-O MQ4-3A or Littelfuse 235-003 fuses.	Outputs are electronically protected

- (1) Input off-to-on filter time is the time from a valid input signal to recognition by the module. Input on-to-off filter time is time from the input signal dropping below the valid level to recognition by the module.
- (2) Output off-to-on or on-to-off delay is the time from the module issuing an output on or off until the output actually turns on or off.

## General Specifications

Attribute	1794-IB10X0B6	1794-IB16X0B16P
Terminal base screw torque	Determined by installed terminal base	
Dimensions, approx. (H x W x D)	94 x 94 x 69 mm (3.7 x 3.7 x 2.7 in.)	
Input indicators (field side)	10 yellow status indicators	16 yellow status indicators
Output indicators (field side)	6 yellow status indicators	
External DC power voltage range	10...31.2V DC (includes 5% AC ripple)	

## General Specifications

Attribute	1794-IB10X0B6	1794-IB16X0B16P
External DC power supply current range	8 mA @ 10V DC 15 mA @ 19.2V DC 19 mA @ 24V DC 25 mA @ 31.2V DC	78 mA @ 10V DC
North American temp code	T3C	
IEC temperature code	T3	—
Keyswitch position	2	
Enclosure type rating	None (open-style)	
Weight, approx.	85 g (3.00 oz)	98 g (3.46 oz)
Wire size	Determined by installed terminal base	
Wiring category <sup>(1)</sup>	2 - on signal ports	

- (1) Use this Conductor Category information for planning conductor routing as described in the appropriate System Level Installation Manual. Also refer to Industrial Automation Wiring and Grounding Guidelines, publication [1770-4.1](#), for more information.

## Environmental Specifications

Attribute	1794-IB10X0B6	1794-IB16X0B16P
Operating temperature	IEC 60068-2-1 (Test Ad, operating cold), IEC 60068-2-2 (Test Bd, operating dry heat), IEC 60068-2-14 (Test Nb, operating thermal shock):	
	-20...55 °C (-4...131 °F)	0...55 °C (32...131 °F)
Storage temperature	IEC 60068-2-1 (Test Ab, unpackaged nonoperating cold), IEC 60068-2-2 (Test Bb, unpackaged nonoperating dry heat), IEC 60068-2-14 (Test Na, unpackaged nonoperating thermal shock): -40...85 °C (-40...185 °F)	
Temperature, surrounding air, max	55 °C (131 °F)	
Relative humidity	IEC 60068-2-30 (Test Db, Unpackaged Damp Heat): 5...95% noncondensing	
Vibration	IEC60068-2-6 (Test Fc, Operating): 5 g @ 10...500 Hz	

**Environmental Specifications**

<b>Attribute</b>	<b>1794-IB10X0B6</b>	<b>1794-IB16X0B16P</b>
Shock, operating	IEC60068-2-27 (Test Ea, Unpackaged shock): 30 g	
Shock, nonoperating	IEC60068-2-27 (Test Ea, Unpackaged shock): 50 g	
Emissions	IEC 61000-6-4	
ESD immunity	IEC 61000-4-2: 6 kV contact discharges 8 kV air discharges	
Radiated RF immunity	IEC 61000-4-3: 10V/m with 1 kHz sine-wave 80% AM from 80...2000 MHz 10V/m with 200 Hz 50% Pulse 100% AM @ 900 MHz 10V/m with 200 Hz 50% Pulse 100% AM @ 1890 MHz	
	3V/m with 1 kHz sine-wave 80% AM from 2000...2700 MHz	1V/m with 1 kHz sine-wave 80% AM from 2000 . . . 2700 MHz
EFT/B immunity	IEC 61000-4-4: $\pm 3$ kV @ 5 kHz on power ports $\pm 2$ kV @ 5 kHz on signal ports	IEC 61000-4-4: $\pm 2$ kV @ 5 kHz on power ports $\pm 2$ kV @ 5 kHz on signal ports
Surge transient immunity	IEC 61000-4-5: $\pm 1$ kV line-line(DM) and $\pm 2$ kV line-earth(CM) on signal ports	
Conducted RF immunity	IEC 61000-4-6: 10V rms with 1 kHz sine-wave 80% AM from 150 kHz . . . 80 MHz	

## Certifications

Certifications (When Product is Marked) <sup>(1)</sup>	Value
c-UL-us	<p><b>(1794-IB10X0B6 only)</b>                      UL Listed Industrial Control Equipment, certified for US and Canada.                      See UL File E65584.                      UL Listed for Class I, Division 2 Group A,B,C,D Hazardous Locations, certified for U.S. and Canada.                      See UL File E194810.</p> <p><b>(1794-IB16X0B16P only)</b>                      UL Listed Industrial Control Equipment, certified for US and Canada.                      See UL File E322657.                      UL Listed for Class I, Division 2 Group A,B,C,D Hazardous Locations, certified for U.S. and Canada.                      See UL File E334470.</p>
CSA	<p><b>(1794-IB10X0B6 only)</b>                      CSA Certified Process Control Equipment.                      See CSA File LR54689C.                      CSA Certified Process Control Equipment for Class I, Division 2 Group A,B,C,D Hazardous Locations.                      See CSA File LR69960C.</p>
CE	<p>European Union 2014/30/EU EMC Directive, compliant with:</p> <ul style="list-style-type: none"> <li>• EN 61326-1; Meas./Control/Lab., Industrial Requirements</li> <li>• EN 61000-6-4; Industrial Emissions</li> <li>• EN 61131-2; Programmable Controllers (Clause 8, Zone A &amp; B)</li> </ul> <p>European Union 2011/65/EU RoHS, compliant with:</p> <ul style="list-style-type: none"> <li>• EN 50581; Technical documentation</li> </ul>
Ex	<p><b>(1794-IB10X0B6 only)</b>                      European Union 2014/34/EU ATEX Directive, compliant with:</p> <ul style="list-style-type: none"> <li>• EN 60079-0; General Requirements</li> <li>• EN 60079-15; Potentially Explosive Atmospheres, Protection "n"</li> <li>• II 3 G Ex nA IIC T3 Gc</li> <li>• DEMKO 14 ATEX 1342501X</li> </ul>
TÜV	<p><b>(1794-IB10X0B6 only)</b>                      TÜV Certified for Functional Safety: up to and including SIL 2</p>
KC	<p>Korean Registration of Broadcasting and Communications Equipment, compliant with:</p> <ul style="list-style-type: none"> <li>• Article 58-2 of Radio Waves Act, Clause 3</li> </ul>
EAC	<p>Russian Customs Union TR CU 020/2011 EMC Technical Regulation</p>
RCM	<p>Australian Radiocommunications Act, compliant with:</p> <ul style="list-style-type: none"> <li>• AS/NZS CISPR 11; Industrial Emissions <b>(1794-IB10X0B6 only)</b></li> <li>• EN 61000-6-4; Industrial Emissions <b>(1794-IB16X0B16P only)</b></li> </ul>

(1) See the Product Certification link at <http://www.rockwellautomation.com/global/certification/overview.page> for Declaration of Conformity, Certificates, and other certification details.

## Derating Curve for 1794-IB16XOB16P

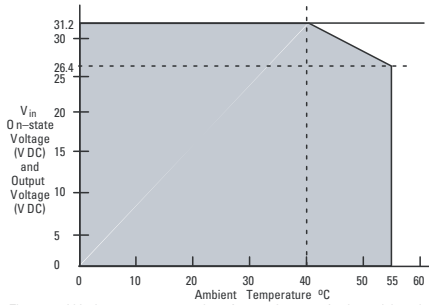

The area within the curve represents the safe operating range for the module under various conditions of user supplied DC supply voltages and ambient temperatures.

 = All mounting positions (including normal horizontal, vertical, inverted horizontal) safe operating range

**Notes:**



**Notes:**

**Notes:**

## Rockwell Automation Support

Use the following resources to access support information.

<b>Technical Support Center</b>	Knowledgebase Articles, How-to Videos, FAQs, Chat, User Forums, and Product Notification Updates.	<a href="http://www.rockwellautomation.com/knowledgebase">www.rockwellautomation.com/knowledgebase</a>
<b>Local Technical Support Phone Numbers</b>	Locate the phone number for your country.	<a href="http://www.rockwellautomation.com/global/support/get-support-now.page">www.rockwellautomation.com/global/support/get-support-now.page</a>
<b>Direct Dial Codes</b>	Find the Direct Dial Code for your product. Use the code to route your call directly to a technical support engineer.	<a href="http://www.rockwellautomation.com/global/support/direct-dial.page">www.rockwellautomation.com/global/support/direct-dial.page</a>
<b>Literature Library</b>	Installation Instructions, Manuals, Brochures, and Technical Data.	<a href="http://www.rockwellautomation.com/literature">www.rockwellautomation.com/literature</a>
<b>Product Compatibility and Download Center (PCDC)</b>	Get help determining how products interact, check features and capabilities, and find associated firmware.	<a href="http://www.rockwellautomation.com/global/support/pcdc.page">www.rockwellautomation.com/global/support/pcdc.page</a>

## Documentation Feedback

Your comments will help us serve your documentation needs better. If you have any suggestions on how to improve this document, complete the How Are We Doing? form at [http://literature.rockwellautomation.com/idc/groups/literature/documents/du/ra-du002\\_-en-e.pdf](http://literature.rockwellautomation.com/idc/groups/literature/documents/du/ra-du002_-en-e.pdf).

Rockwell Automation maintains current product environmental information on its website at <http://www.rockwellautomation.com/rockwellautomation/about-us/sustainability-ethics/product-environmental-compliance.page>.

Allen-Bradley, Rockwell Automation, FLEX I/O, Rockwell Software, and TechConnect are trademarks of Rockwell Automation, Inc. Trademarks not belonging to Rockwell Automation are property of their respective companies.

Rockwell Otomasyon Ticaret A.Ş., Kar Plaza İş Merkezi E Blok Kat:6 34752 İçerenköy, İstanbul, Tel: +90 (216) 5698400

[www.rockwellautomation.com](http://www.rockwellautomation.com)

**Power, Control and Information Solutions Headquarters**

Americas: Rockwell Automation, 1201 South Second Street, Milwaukee, WI 53204-2496 USA, Tel: (1) 414.382.2000, Fax: (1) 414.382.4444  
Europe/Middle East/Africa: Rockwell Automation NV, Pegasus Park, De Kleetlaan 12a, 1831 Diegem, Belgium, Tel: (32) 2 663 0600, Fax: (32) 2 663 0640  
Asia Pacific: Rockwell Automation, Level 14, Core F, Cyberport 3, 100 Cyberport Road, Hong Kong, Tel: (852) 2887 4788, Fax: (852) 2508 1846

**Publication 1794-IN083D-EN-P - July 2018**

Supersedes Publication 1794-IN083C-EN-P - August 2015

Copyright © 2018 Rockwell Automation, Inc. All rights reserved.