

PowerFlex 1203-USB Converter



Firmware Revision 1.xxx

User Manual



Important User Information

Solid state equipment has operational characteristics differing from those of electromechanical equipment. *Safety Guidelines for the Application, Installation and Maintenance of Solid State Controls* (Publication SGI-1.1 available from your local Rockwell Automation sales office or online at <http://www.rockwellautomation.com/literature>) describes some important differences between solid state equipment and hard-wired electromechanical devices. Because of this difference, and also because of the wide variety of uses for solid state equipment, all persons responsible for applying this equipment must satisfy themselves that each intended application of this equipment is acceptable.

In no event will Rockwell Automation, Inc. be responsible or liable for indirect or consequential damages resulting from the use or application of this equipment.

The examples and diagrams in this manual are included solely for illustrative purposes. Because of the many variables and requirements associated with any particular installation, Rockwell Automation, Inc. cannot assume responsibility or liability for actual use based on the examples and diagrams.

No patent liability is assumed by Rockwell Automation, Inc. with respect to use of information, circuits, equipment, or software described in this manual.

Reproduction of the contents of this manual, in whole or in part, without written permission of Rockwell Automation, Inc. is prohibited.

Throughout this manual, when necessary we use notes to make you aware of safety considerations.



WARNING: Identifies information about practices or circumstances that can cause an explosion in a hazardous environment, which may lead to personal injury or death, property damage, or economic loss.

Important: Identifies information that is critical for successful application and understanding of the product.



ATTENTION: Identifies information about practices or circumstances that can lead to personal injury or death, property damage, or economic loss. Attentions help you identify a hazard, avoid a hazard, and recognize the consequences.



Shock Hazard labels may be located on or inside the equipment (e.g., drive or motor) to alert people that dangerous voltage may be present.



Burn Hazard labels may be located on or inside the equipment (e.g., drive or motor) to alert people that surfaces may be at dangerous temperatures.

Allen-Bradley, Rockwell Automation, TechConnect, RSLogix, PowerFlex, Kinetix, SMC Flex, Connected Components Workbench, DriveExplorer, and DriveExecutive are trademarks of Rockwell Automation, Inc.
Trademarks not belonging to Rockwell Automation are property of their respective companies.

Summary of Changes

The information below summarizes the changes made to this manual since its last release (September 2012):

Description of Changes	Page
In the 'Components' section, added information about the 2090-CCMUSDS-48AA0x cable required for use with Kinetix 3 drives.	1-2
In the 'Compatible Products' section, added Kinetix 3 drives to the DSI Products subsection.	1-4
In the 'Quick Start' section in step 2 for DSI drives, revised 'sub-step a' to include the 2090-CCMUSDS-48AA0x cable required for use with Kinetix 3 drives.	1-6
In Figure 1.2, added the 2090-CCMUSDS-48AA0x cable required for use with Kinetix 3 drives.	1-7
In the 'Connecting the Converter to a DSI Drive and the Computer' subsection, added the 2090-CCMUSDS-48AA0x cable required for use with Kinetix 3 drives.	2-3

Notes:

Preface	About This Manual	
	Conventions Used in This Manual	P-1
	Rockwell Automation Support	P-1
	Local Product Support	P-1
	Technical Product Assistance	P-1
	Additional Resources	P-2
Chapter 1	Getting Started	
	Components	1-2
	Features	1-2
	Compatible Products	1-3
	DPI Products	1-3
	DSI Products	1-4
	SCANport Products	1-4
	Required Equipment	1-4
	Equipment Shipped with the Converter	1-4
	User-Supplied Equipment	1-5
	Safety Precautions	1-6
	Quick Start	1-6
Chapter 2	Installing the Converter	
	Connecting the Cables	2-1
	Connecting the Converter to a DPI or SCANport Drive and the Computer	2-2
	Connecting the Converter to a DSI Drive and the Computer	2-3
	Installing the USB Drivers	2-4
	Download Both USB Drivers to the Computer	2-4
	Install Both USB Drivers	2-4
	Installing Connected Components Workbench Software	2-12
	Powering Up the Converter	2-12
	Removing the Converter	2-13
Chapter 3	Configuring the Converter	
	Configuration Tools	3-1
	Using Connected Components Workbench Software	3-2
	Resetting the Converter	3-7
	Updating the Firmware	3-8
	Using RTU Master Mode for a Serial Multi-drop Network	3-8
	Network Wiring	3-8
	Establishing Communication	3-10
	Configuring the Drive Parameters	3-10
	Configuring the Converter for RTU Master Mode	3-11
	Configuring RSLinx for Serial Multi-Drop System	3-12
	Accessing Drives on the RTU Master (Serial Multi-drop) Network	3-14

Chapter 4	Troubleshooting	
	Understanding the Status Indicators	4-1
	Diamond Status Indicator	4-2
	RX Status Indicator	4-2
	TX Status Indicator	4-2
	Converter Diagnostic Items	4-3
	Diagnostic Items for DPI Drives	4-3
	Diagnostic Items for DSI Drives	4-3
	Diagnostic Items for SCANport Drives	4-3
	Viewing Diagnostic Data	4-4
	Converter Events	4-6
	Event Codes for DPI Drives	4-6
	Event Codes for DSI Drives	4-7
	Event Codes for SCANport Drives (DriveExplorer or DriveExecutive software only)	4-7
	Viewing and Clearing Events	4-8
	Viewing and Clearing DF1 Communication Statistics	4-9
	Troubleshooting Potential Problems	4-10
	Unable to Establish Connection Between the Computer and Converter	4-10
	No Communication to the Drive	4-10
	Cannot Communicate with a SCANport-based Drive	4-10
Appendix A	Specifications	
	Communications	A-1
	Electrical	A-1
	Mechanical	A-1
	Environmental	A-2
	Agency Certification	A-2
Appendix B	Converter Parameters	
	Parameters – DPI Drives	B-1
	Parameters – DSI Drives	B-2
	Parameters – SCANport Drives (DriveExplorer or DriveExecutive software only)	B-4
Appendix C	Use with DriveExplorer Software	
	Installing DriveExplorer Software	C-1
	Configuring the Converter	C-2
	Resetting the Converter	C-4
	Preparing for a Firmware Update	C-4
	Updating the Firmware	C-5
	Troubleshooting	C-5
	Viewing Diagnostic Data	C-5
	Viewing and Clearing Events	C-6
	Viewing and Clearing DF1 Communication Statistics	C-7
	Using RTU Master Mode for a Serial Multi-drop Network	C-8
	Network Wiring	C-8
	Establishing Communication	C-8
	Configuring the Drive Parameters	C-8
	Configuring the Converter for RTU Master Mode	C-9
	Accessing Drives on the RTU Master (Serial Multi-drop) Network	C-9

Appendix D	Use with DriveExecutive Software	
	Installing DriveExecutive Software	D-1
	Configuring the Converter	D-2
	Resetting the Converter	D-6
	Preparing for a Firmware Update	D-6
	Updating the Firmware	D-7
	Troubleshooting	D-7
	Viewing Diagnostic Data	D-7
	Viewing and Clearing Events	D-8
	Viewing and Clearing DF1 Communication Statistics	D-9
	Using RTU Master Mode for a Serial Multi-drop Network	D-10
	Network Wiring	D-10
	Establishing Communication	D-10
	Configuring the Drive Parameters	D-10
	Configuring the Converter for RTU Master Mode	D-11
	Configuring RSLinx for Serial Multi-Drop	D-11
	Accessing Drives on the RTU Master (Serial Multi-drop) Network	D-14
Appendix E	Use with HyperTerminal Software	
	Configuring the Converter	E-1
	Navigating with Terminal Emulation Software	E-4
	Resetting the Converter	E-4
	Preparing for a Firmware Update	E-5
	Updating Firmware	E-5
	Troubleshooting	E-6
	Viewing Diagnostic Data	E-6
	Viewing and Clearing Events	E-6
	Viewing and Clearing DF1 Communication Statistics	E-7
Appendix F	History of Changes	
	DRIVES-UM001C-EN-P, September 2012	F-1
	DRIVES-UM001B-EN-P, October 2006	F-1

Glossary

Index

About This Manual

This manual provides the basic information needed to install, start up, and troubleshoot the PowerFlex 1203-USB Converter.

Topic	Page
Additional Resources	P-2
Rockwell Automation Support	P-1
Conventions Used in This Manual	P-1

Conventions Used in This Manual

The following conventions are used throughout this manual:

- Parameter names are shown in the format **Parameter xx - [*]**. The xx represents the parameter number. The * represents the parameter name—for example, **Parameter 01 - [DPI Port]** for use with DPI drives, or **Parameter 01 - [Adapter Cfg]** for use with DSI drives.
- The firmware revision number (FRN) is displayed as X.xxx, where 'X' is the major revision number and 'xxx' is the minor revision number.

Rockwell Automation Support

Rockwell Automation offers support services worldwide, with over 75 sales and support offices, over 500 authorized distributors, and over 250 authorized systems integrators located throughout the United States alone. In addition, Rockwell Automation representatives are in every major country in the world.

Local Product Support

Contact your local Rockwell Automation representative for the following:

- Sales and order support
- Product technical training
- Warranty support
- Support service agreements

Technical Product Assistance

For technical assistance, please review the information in [Chapter 4, Troubleshooting](#), first. If you still have problems, then access the Allen-Bradley® Technical Support website at <http://www.ab.com/support/abdrives> or contact Rockwell Automation.

Additional Resources

These resources contain additional information concerning related products from Rockwell Automation.

Resource	Description
Connected Components Workbench website at http://www.ab.com/support/abdrives/webupdate/software.html , and online help	Information on the Connected Components Workbench™ software tool—and includes link for free software download.
DriveExplorer website at http://www.ab.com/drives/driveexplorer , and online help	Information on using the DriveExplorer™ software tool.
DriveExecutive website at http://www.ab.com/drives/drivetools , and online help	Information on using the DriveExecutive™ software tool.

You can view or download publications at <http://www.rockwellautomation.com/literature>. To order paper copies of technical documentation, contact your local Allen-Bradley distributor or Rockwell Automation sales representative.

To find your local Rockwell Automation distributor or sales representative, visit <http://www.rockwellautomation.com/locations>.

For information such as firmware updates or answers to drive-related questions, go to the Drives Service & Support website at <http://www.ab.com/support/abdrives> and click the Downloads or Knowledgebase link.

Getting Started

The 1203-USB converter provides a communications interface between a computer and any Allen-Bradley product supporting these drive communication interfaces:

- DPI (Drive Peripheral Interface) for PowerFlex[®] 7-Class drives and PowerFlex 750-Series drives
- DSI (Drive Serial Interface) for PowerFlex 4-Class drives, PowerFlex 520-Series drives, and Kinetix 3 drives
- SCANport for legacy 1305 drives, 1336 drives, and so forth

The 1203-USB converter uses the full-duplex, RS-232 DF1 protocol.

Topic	Page
Components	1-2
Features	1-2
Compatible Products	1-3
Required Equipment	1-4
Safety Precautions	1-6
Quick Start	1-6

Components

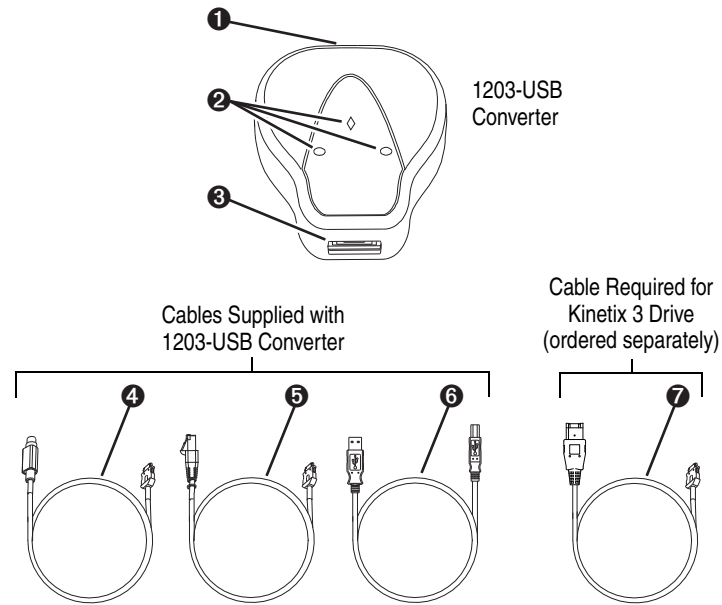

Item	Part	Description
1	Computer Cable Port	Plug the USB cable into this port.
2	Status Indicators	LEDs that indicate converter operation, data being received from the computer, and data being sent to the computer. For more information, see Chapter 4, Troubleshooting .
3	Drive Cable Port	<ul style="list-style-type: none"> DPI Drives or SCANport Legacy Drives: Plug the 20-HIM-H10 cable into this port. DSI Drives: Plug the 22-HIM-H10 cable (for PowerFlex drives) or the 2090-CCMUSDS-48AA0x cable (for Kinetix 3 drives) into this port.
4	20-HIM-H10 Cable	DPI or SCANport drive cable (1 m length) with male 26-pin-to-male 8-pin circular mini-DIN connectors.
5	22-HIM-H10 Cable	DSI drive cable (1 m length) with male 26-pin-to-male RJ45 connectors for use with PowerFlex drives.
6	USB Cable	USB cable (2 m length) with a Type B connector on one end to connect to the 1203-USB converter, and a Type A connector on the other end of the cable to connect to a computer.
7	2090-CCMUSDS-48AA0x Cable (ordered separately)	DSI drive cable (1 m or 3 m length) with male 26-pin-to-male 6-pin IEEE 1394 connectors for use with Kinetix 3 drives.

Features

The features of the 1203-USB converter include the following:

- Connects to, and is compatible with, products that support the Allen-Bradley DPI, DSI, and SCANport drive communication interfaces (see [Compatible Products on page 1-3](#)).

The 1203-USB converter autobauds to the appropriate communication data rate that is used by the drive.

- Provides a means for configuration software tools to access parameters in supported drives.

- Compatibility with various drive configuration tools to configure the 1203-USB converter and connected drive as shown below.

Configuration Tool	1203-USB	DPI Drive	DSI Drive	SCANport Drive
Connected Components Workbench Software, version 1.02 or later	Yes	Yes	Yes	No
DriveExplorer Lite or Full software, version 4.04 or later	Yes	Yes	Yes ⁽¹⁾	Yes
DriveExecutive software, version 1.01 or later	Yes	Yes	Yes ⁽¹⁾	Yes
Terminal emulation software, such as HyperTerminal	Yes	not recommended		

⁽¹⁾ Except PowerFlex 520-Series drives and Kinetix 3 drives.

- Status indicators to report the operating status of the converter.
- Fixed baud rate of 115.2 kbps.
- Receives power from the connected host drive, eliminating the need for a dedicated power source.
- Upgradable firmware to get new features as they become available.

Compatible Products

At the time of publication, the 1203-USB converter is compatible with the following products.



TIP: Also check the supported products by the various drive software tools. For example, the PowerFlex 520-Series drives and Kinetix 3 drives are only supported by Connected Components Workbench software and not DriveExplorer or DriveExecutive software.

DPI Products

- PowerFlex 70/70EC drives
- PowerFlex 700/700VC drives
- PowerFlex 700 Series B drives
- PowerFlex 700H drives
- PowerFlex 700S drives
- PowerFlex 700L
- PowerFlex 753 drives
- PowerFlex 755 drives
- PowerFlex Digital DC drives
- PowerFlex 7000 drives
- SMCTM Flex Smart Motor Controllers
- SMC-50 Smart Motor Controllers
- MSR57 Speed Monitoring Safety Relays

DSI Products

- PowerFlex 4 drives
- PowerFlex 4M drives
- PowerFlex 40 drives
- PowerFlex 40P drives
- PowerFlex 400 drives
- PowerFlex 520-Series drives (Some limitations of use - Custom groups and Application groups are not supported)
- Kinetix 3 drives (Only point-to-point connection supported)

SCANport Products

- 1305 AC drives, firmware 2.01 or later
- 1336 FORCE™ drives
- 1336 IMPACT™ drives
- 1336 PLUS drives
- 1336 PLUS II drives
- 1336 REGEN Line Regeneration Packages
- 1336 SPIDER drives
- 1394 Motion systems
- 1397 DC drives
- 1557 Medium Voltage drives
- 2364 Regenerative DC Bus Supply Units
- SMC Dialog Plus™ Smart Motor Controllers
- SMP-3 Smart Motor Protectors

Required Equipment

Most of the equipment that is required to use the 1203-USB converter is shipped with the converter, but some equipment you must supply yourself.

Equipment Shipped with the Converter

When you unpack the converter, verify that the package includes the following:

- One 1203-USB converter
- One USB cable, 2 m (6.6 ft.) long
- One 20-HIM-H10 cable, 1 m (3.3 ft.) long
- One 22-HIM-H10 cable, 1 m (3.3 ft.) long

User-Supplied Equipment

To configure the 1203-USB converter and connected Allen-Bradley drives, you must supply one of the following drive configuration software tools on your computer:

- Connected Components Workbench software, version 1.02 or later

Connected Components Workbench is the recommended stand-alone software tool for use with PowerFlex drives. You can obtain a free copy by:

- Internet download at <http://www.ab.com/support/abdrives/webupdate/software.html>
- Requesting a DVD at <http://www.ab.com/onecontact/controllers/micro800/>

Your local distributor may also have copies of the DVD available.

Connected Components Workbench software cannot be used to configure SCANport-based drives or Bulletin 160 drives. Use one of the other drive software tools listed below for this specific purpose.

- DriveExplorer software, version 4.04 or later

This software tool has been discontinued and is now available as freeware at <http://www.ab.com/support/abdrives/webupdate/software.html>. There are no plans to provide future updates to this tool and the download is being provided 'as-is' for users that lost their DriveExplorer CD, or need to configure legacy products not supported by Connected Components Workbench software.

- DriveExecutive software, version 1.01 or later

A Lite version of DriveExecutive software ships with RSLogix 5000, RSNetWorx MD, FactoryTalk AssetCentre, and IntelliCENTER software. All other versions are purchasable items:

- 9303-4DTE01ENE DriveExecutive software
- 9303-4DTS01ENE DriveTools SP Suite (includes DriveExecutive and DriveObserver software)
- 9303-4DTE2S01ENE DriveExecutive software upgrade to DriveTools SP Suite (adds DriveObserver software)

DriveExecutive software updates (patches, and so forth) can be obtained at <http://www.ab.com/support/abdrives/webupdate/software.html>. It is highly recommended that you periodically check for and install the latest update.

- Terminal emulation software, such as HyperTerminal

Safety Precautions

Please read the following safety precautions carefully.



ATTENTION: Risk of injury or equipment damage exists. Only personnel familiar with drive and power products and the associated machinery should plan or implement the installation, startup, configuration, and subsequent maintenance of the product using the converter. Failure to comply may result in injury and/or equipment damage.



ATTENTION: Risk of injury or equipment damage exists. If the converter is transmitting control I/O to the drive (indicated by a steady green Diamond status indicator), the drive may fault when you remove or reset the converter. Determine how your drive will respond before removing or resetting a connected converter.

Quick Start

This section is provided to help experienced users quickly start using the 1203-USB converter. If you are unsure how to complete a step, refer to the referenced chapter.

Step	Action	See
1	Review the safety precautions for the converter.	Throughout this manual
2	<p>Install the converter.</p> <p>When used with DPI drives or SCANport drives:</p> <ol style="list-style-type: none"> Connect the 1203-USB converter to the drive with a 20-HIM-H10 cable (see Figure 1.1). Connect the 1203-USB converter to a computer with a USB cable. <p>Make sure that power has been applied to the drive.</p> <p>When used with DSI drives:</p> <ol style="list-style-type: none"> Connect the 1203-USB converter to the PowerFlex drive with a 22-HIM-H10 cable, or to the Kinetix 3 drive with a 2090-CCMUSDS-48AA0x cable (see Figure 1.2). Connect the 1203-USB converter to a computer with a USB cable. <p>Make sure that power has been applied to the drive.</p>	Chapter 2, Installing the Converter
3	Install the 1203-USB driver and USB serial port driver.	Installing the USB Drivers on page 2-4
4	<p>Configure the converter for your application.</p> <p>Use one of the following tools to configure parameters in the converter:</p> <ul style="list-style-type: none"> Connected Components Workbench software, version 1.02 or later DriveExplorer software, version 4.04 or later DriveExecutive software, version 1.01 or later Terminal emulation software, such as HyperTerminal 	Chapter 3, Configuring the Converter , or Appendix C, Use with DriveExplorer Software , or Appendix D, Use with DriveExecutive Software , or Appendix E, Use with HyperTerminal Software

Figure 1.1 Connecting the Converter Between a DPI or SCANport Drive and Computer

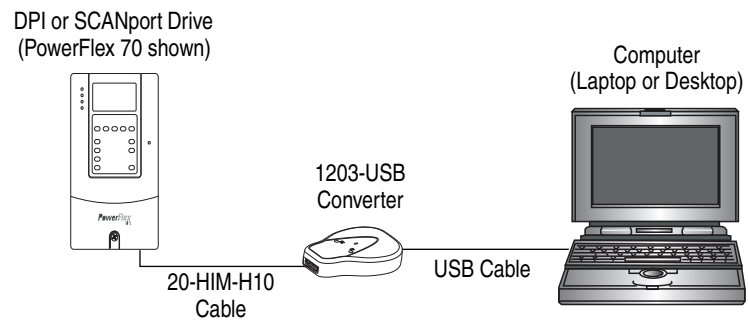
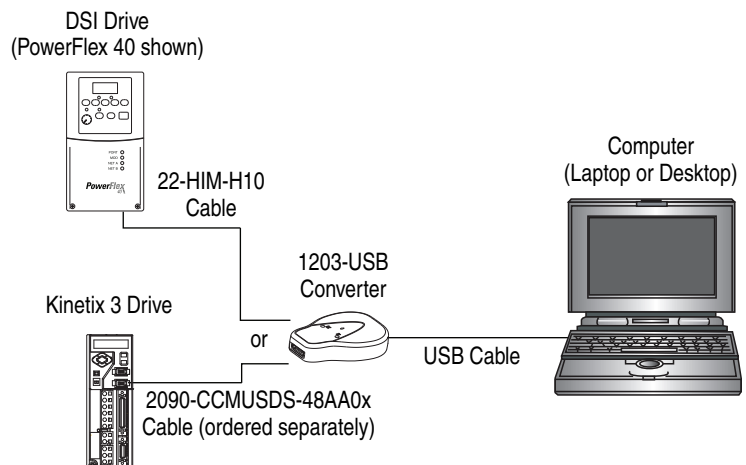

Figure 1.2 Connecting the Converter Between a DSI Drive and Computer



Notes:

Installing the Converter

This chapter provides instructions for installing and removing the 1203-USB converter.

Topic	Page
Connecting the Cables	2-1
Installing Connected Components Workbench Software	2-12
Installing the USB Drivers	2-4
Powering Up the Converter	2-12
Removing the Converter	2-13

Connecting the Cables

Important: The converter **must not** be installed in an area where the ambient atmosphere contains volatile or corrosive gas, vapors or dust. If the converter is not going to be installed for a period of time, it must be stored in an area where it will not be exposed to a corrosive atmosphere.

Only two of the three supplied cables are required to install the 1203-USB converter between the drive and computer.



TIP: Always use the USB cable to connect the converter to the computer.

For a list of compatible products, see [Compatible Products on page 1-3](#).

Connecting the Converter to a DPI or SCANport Drive and the Computer

Use the 20-HIM-H10 cable to connect the converter to a DPI or SCANport drive. Use the USB cable to connect the converter to the computer.

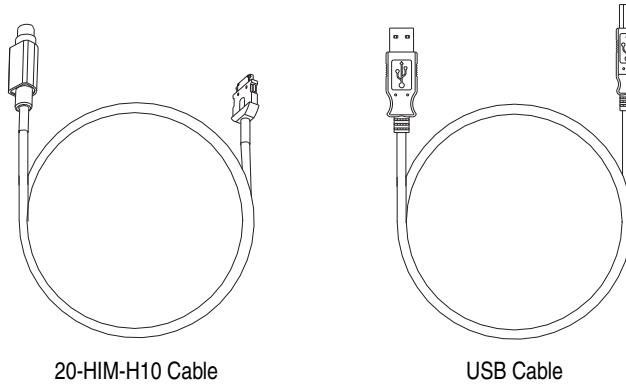

1. Connect the 20-HIM-H10 cable between the converter and the DPI or SCANport drive.

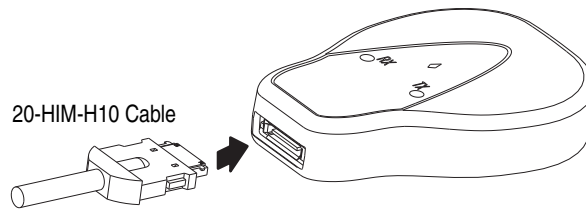

2. Connect the USB cable between the converter and the computer.

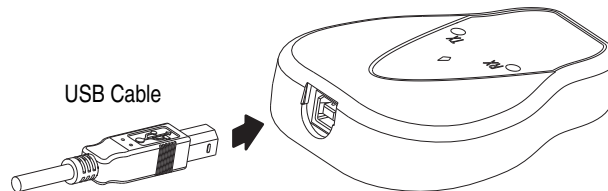

Connecting the Converter to a DSI Drive and the Computer

Use the 22-HIM-H10 cable to connect the converter to a DSI drive. Use the USB cable to connect the converter to the computer.

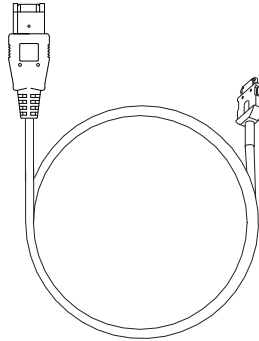

2090-CCMUSDS-48AA0x Cable
(for Kinetix 3 drives and ordered separately)

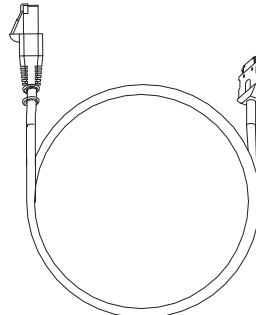

22-HIM-H10 Cable
(for PowerFlex drives)

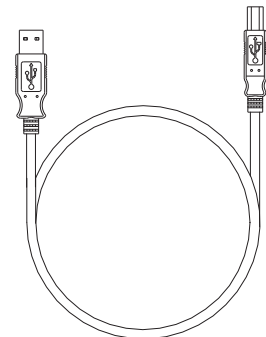

USB Cable

Important: The 22-HIM-H10 cable shield must be properly grounded to provide EMC protection. For example, terminal 16 on a PowerFlex 4-Class drive and terminal C1 on a PowerFlex 520-Series drive should be connected to the drive earth ground. See the respective drive User Manual for additional information.

1. Connect the 22-HIM-H10 cable (required for PowerFlex drives) or the 2090-CCMUSDS-48AA0x cable (required for Kinetix 3 drives) between the converter and the DSI drive.

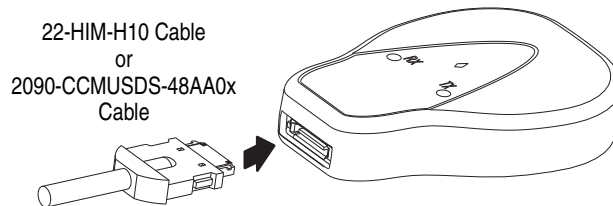

2. Connect the USB cable between the converter and the computer.

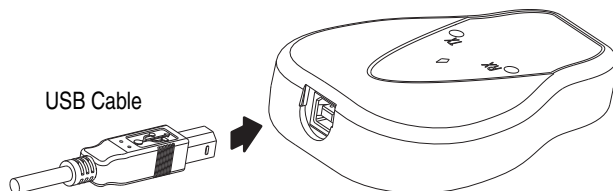

Installing the USB Drivers

The following two USB drivers must be installed on your computer to enable the computer to recognize the 1203-USB converter when using any of the configuration tools (Connected Components Workbench, DriveExplorer, DriveExecutive, or HyperTerminal software):

- USB Converter driver
- USB Serial Port driver

If you intend to use Connected Components Workbench software, version 2.xx or later, to configure the converter and connected drive, these two USB drivers are automatically installed during the installation of this software. However, if you intend to use an earlier version of this software tool or DriveExplorer, DriveExecutive, or HyperTerminal software, you must manually install these two USB drivers. This requires downloading and extracting both USB drivers to the computer, and then installing both USB drivers. For instructions to do this, see the next two subsections.

Download Both USB Drivers to the Computer

To obtain both USB drivers required for the 1203-USB converter and USB serial port, perform the following steps.

1. Go to the Allen-Bradley Web Updates website at <http://www.ab.com/support/abdrives/webupdate>.
2. Click the 1203-USB link in the 7-Class or 4-Class Peripherals section.
3. Download the zip file to a unique location on your computer.
4. Unzip the file to access the executable files for both USB drivers.

Install Both USB Drivers

Most personal computers today use the Windows XP™ or Windows 7™ operating system. See the appropriate subsection below for instructions that correspond with the operating system being used.

When Using the Windows XP Operating System

1. After connecting the 1203-USB converter to a powered drive and to the computer, the 'Found New Hardware Wizard' screen should appear.



If this screen did not appear, perform the following steps:

- a. Open the Windows Control Panel and double-click System.
 - b. In the System Properties window, click the Hardware tab.
 - c. Click Device Manager.
 - d. Expand 'Universal Serial Bus controllers' in the treeview.
 - e. Right-click the USB Converter and choose Update Driver.
 - f. When the above screen appears, proceed to step 2.
2. Click 'No, not this time'.
 3. Click Next > to continue (next wizard screen appears).

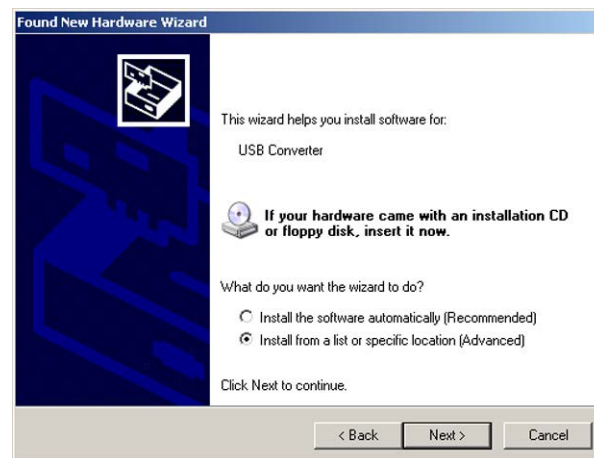

4. Click 'Install from a list or specific location (Advanced)'.

5. Click Next > to continue (next wizard screen appears).

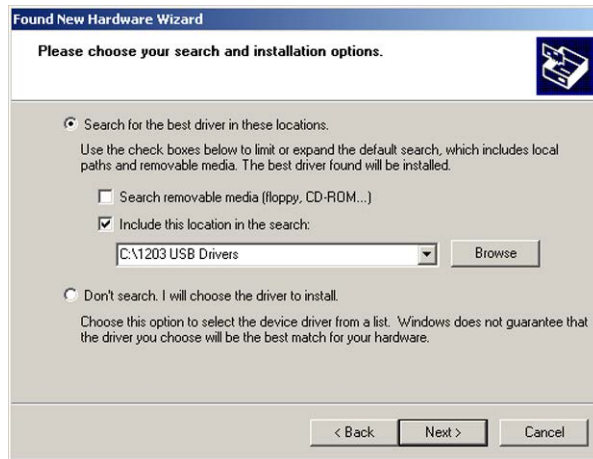

6. Check 'Include this location in the search'.

7. Click Browse.

Browse to the location on the computer where the executable files for both USB drivers were unzipped (step 4 in the [Download Both USB Drivers to the Computer](#) section).

8. Click Next >.

9. After the 1203-USB driver has been successfully installed, a confirmation screen appears.



10. Click Finish.

11. After approximately 20 seconds, the 'Found New Hardware Wizard' screen should appear again.



12. Click 'No, not at this time'.
13. Click Next > to continue (next wizard screen appears).



14. Click 'Install from a list or specific location (Advanced)'.
15. Click Next > to continue (next wizard screen appears).

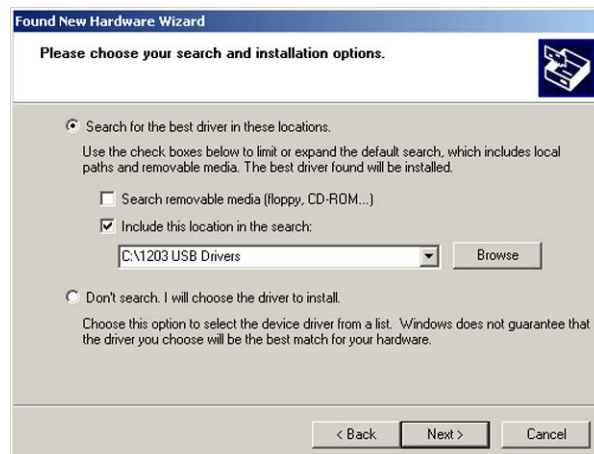

16. Check 'Include this location in the search'.
17. Click Browse.
Browse to the location on the computer where the executable files for both USB drivers were unzipped (step 4 in the [Download Both USB Drivers to the Computer](#) section).
18. Click Next >.
19. After the USB Serial Port driver has been successfully installed, a confirmation screen appears.



20. Click Finish.
21. Verify that the drivers have been correctly installed by expanding Ports (COM & LPT) in the Device Manager treeview as shown below.

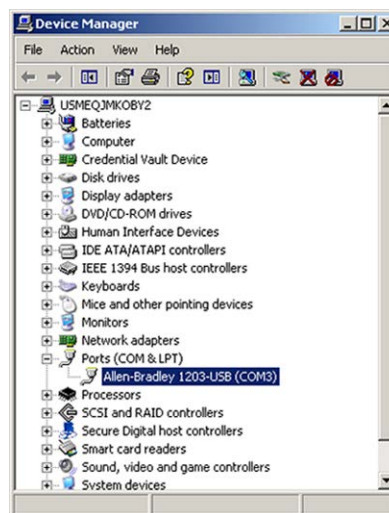

'Allen-Bradley 1203-USB (COMx)' should appear in the treeview. Note the COM port being used. This COM port number will be used later to configure a driver using RSLinx software to represent the connection on the COM port. This is required for either the Connected Components Workbench or DriveExecutive software tool. See [Using Connected Components Workbench Software on page 3-2](#) or, for DriveExecutive software, [Configuring the Converter on page D-2](#) for details.

When Using the Windows 7 Operating System

1. After connecting the 1203-USB converter to a powered drive and to the computer, open the Windows Control Panel.
2. Click Device Manager.
3. Expand 'Other Devices' in the treeview.
4. Right-click the USB Converter and choose 'Update Driver Software'.

The following screen appears.

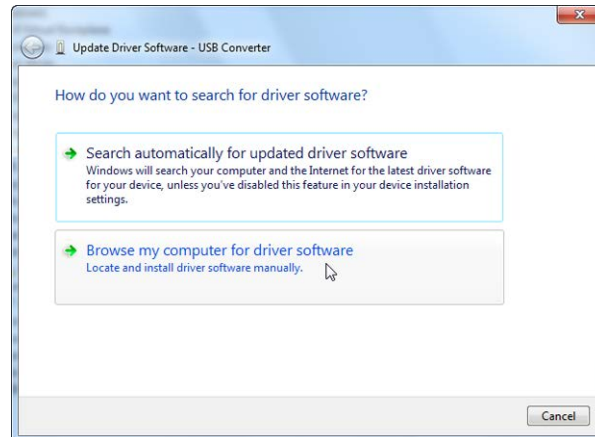

5. Click 'Browse my computer for driver software'.

The following screen appears.

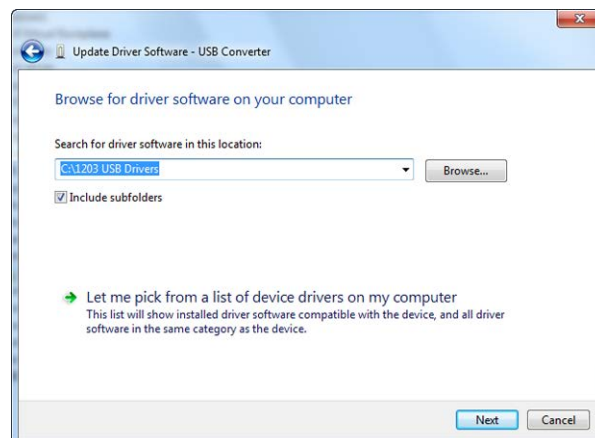

6. Check 'Include subfolders'.
7. Click Browse.

Browse to the location on the computer where the executable files for both USB drivers were unzipped (step 4 in the [Download Both USB Drivers to the Computer](#) section).

8. Click Next.

9. After the 1203-USB driver has been successfully installed, a confirmation screen appears.

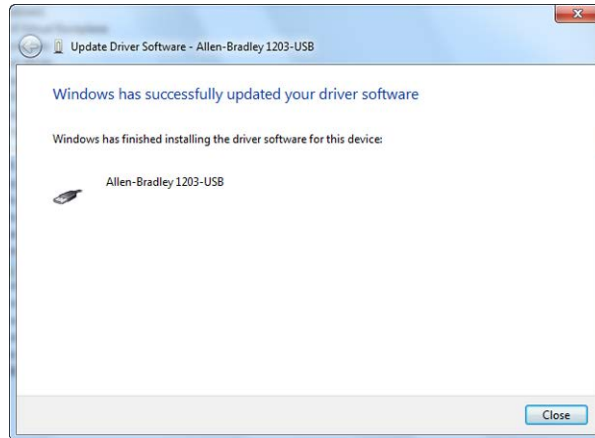

10. Click Close.
11. After the USB Converter driver has been successfully installed, the USB Serial Port driver must be installed. Open the Windows Control Panel.
12. Click Device Manager.
13. Expand 'Other Devices' in the treeview.
14. Right-click the USB Serial Port and choose 'Update Driver Software'.

The following screen appears.

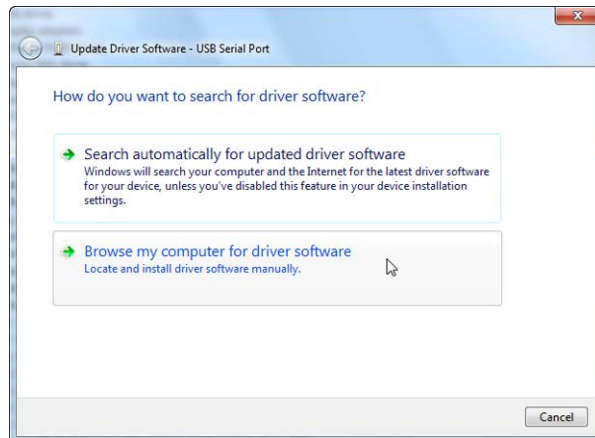

15. Click 'Browse my computer for driver software'.

The following screen appears.

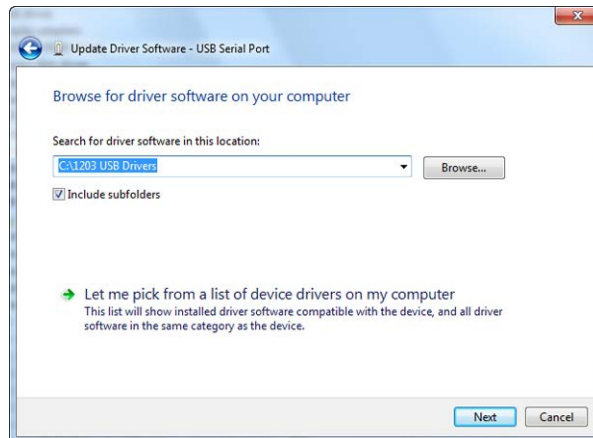

16. Check 'Include subfolders'.

17. Click Browse.

Browse to the location on the computer where the executable files for both USB drivers were unzipped (step 4 in the [Download Both USB Drivers to the Computer](#) section).

18. Click Next.

19. After the USB Serial Port driver has been successfully installed, a confirmation screen appears.

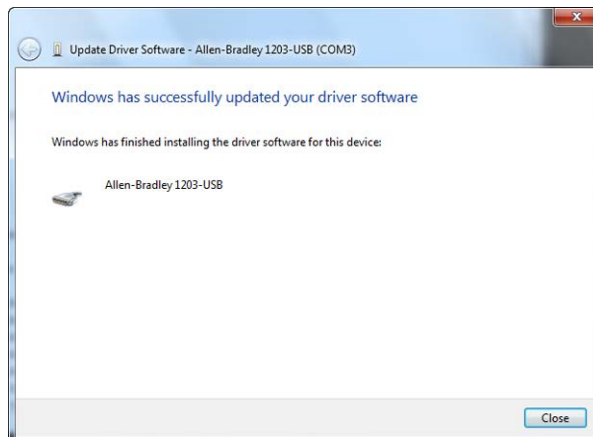

20. Click Close.

21. Verify that the drivers have been correctly installed by expanding Ports (COM & LPT) in the Device Manager treeview as shown below.

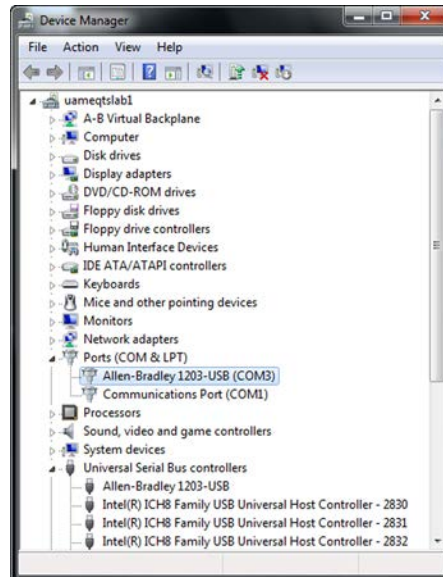

'Allen-Bradley 1203-USB (COMx)' should appear in the treeview. Note the COM port being used. This COM port number will be used later to configure a driver using RSLinx software to represent the connection on the COM port. This is required for either the Connected Components Workbench or DriveExecutive software tool. See [Using Connected Components Workbench Software on page 3-2](#) or, for DriveExecutive software, [Configuring the Converter on page D-2](#) for details.

Installing Connected Components Workbench Software

If you do not have Connected Components Workbench software on your computer and intend to use it as your configuration tool, you can obtain a **free copy**. See [User-Supplied Equipment on page 1-5](#) for details. Follow the instructions included with the software.

Powering Up the Converter

The 1203-USB converter receives power from the drive, so the drive must be powered before the converter will operate. The Diamond status indicator on the converter flashes green to indicate that the converter is properly installed and receiving power. If it is not green, see [Chapter 4, Troubleshooting](#).

Removing the Converter



ATTENTION: Risk of injury or equipment damage exists. If the converter is transmitting control I/O to the drive (indicated by a steady green Diamond status indicator), the drive may fault when you remove or reset the converter. Determine how your drive will respond before removing or resetting a connected converter.

1. Disconnect the cable from the drive, and then from the converter.
To disconnect the cable, press on the cable latch and then pull it out.
2. Disconnect the USB cable from the converter, and then from the computer.

Notes:

Configuring the Converter

This chapter provides instructions and information for setting the parameters to configure the 1203-USB converter.

Topic	Page
Configuration Tools	3-1
Using Connected Components Workbench Software	3-2
Resetting the Converter	3-7
Updating the Firmware	3-8
Using RTU Master Mode for a Serial Multi-drop Network	3-8

For a list of parameters, see the following sections:

- [Parameters – DPI Drives on page B-1](#)
- [Parameters – DSI Drives on page B-2](#)
- [Parameters – SCANport Drives \(DriveExplorer or DriveExecutive software only\) on page B-4](#)

For definitions of terms in this chapter, see the [Glossary](#).

Configuration Tools

The 1203-USB converter stores parameters and other information in its own nonvolatile storage (NVS) memory. You must, therefore, access the converter to view and edit its parameters. The following tools can be used to access the converter parameters.

Tool	Page
Connected Components Workbench Software, version 1.02 or later	3-2
DriveExplorer Software, version 4.04 or later	C-1
DriveExecutive Software, version 1.01 or later	D-1
Terminal Emulation Software (such as HyperTerminal)	E-1

Important: The RS-485 serial port on DSI drives does not need to be configured before using the converter. DSI communications are configured automatically (19.2K baud and 8-N-1).

Using Connected Components Workbench Software

With Connected Components Workbench software, version 1.02 or later, you can edit parameters in both the 1203-USB converter and the connected drive. With DPI and DSI drives, you can also edit parameters in any of their connected peripherals.

Important: For Connected Components Workbench software to operate with DSI drives point-to-point, converter **Parameter 01 - [Adapter Cfg]** must be set to '0' (Auto, the default). If this parameter needs to be changed, HyperTerminal software can be used to configure the converter (see [Use with HyperTerminal Software on page E-1](#)).

This procedure is provided to help you use Connected Components Workbench software with the 1203-USB converter. If you are unsure how to complete a step, refer to the software online help (from the Help menu, choose Help Topics).

1. Obtain and note the COM port that was assigned during installation of the 1203-USB driver (on [page 2-8](#)) by doing the following.

When Using Windows XP Operating System

- a. Open the Windows Control Panel and double-click System.
- b. In the System Properties window, click the Hardware tab.
- c. Click Device Manager.

When Using Windows 7 Operating System

- a. Open the Windows Control Panel.
- b. Click Device Manager.

2. In the Device Manager treeview, expand the Ports (COM & LPT) group.

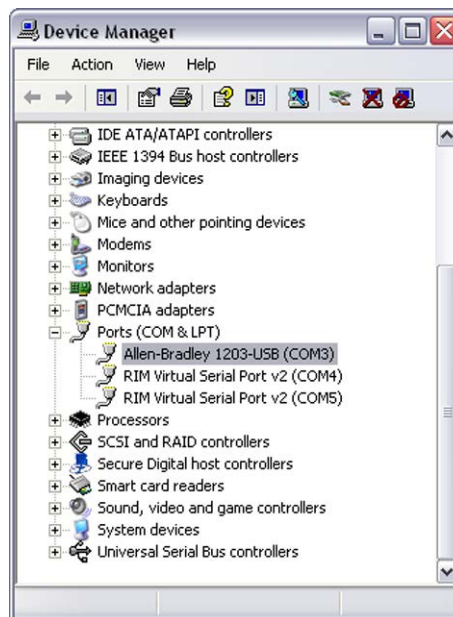

The assigned COM port is shown in parenthesis at the end of the Allen-Bradley 1203-USB entry.

3. Launch RSLinx software to create a driver to represent the connection on the communication port noted in step 1.
4. From the Communications menu, choose Configure Drivers to display the Configure Drivers dialog box.
5. From the Available Driver Types pull-down menu, choose RS-232 DF1 devices.

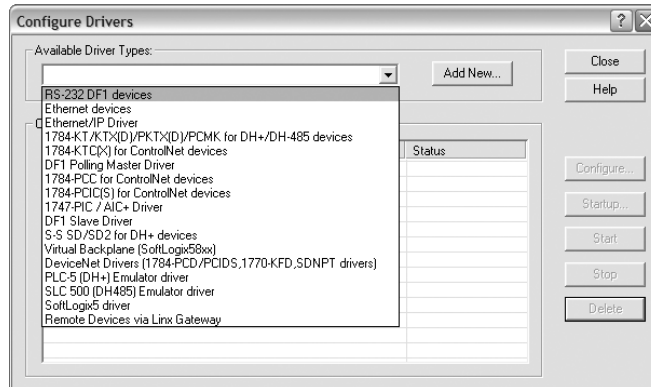

6. After the driver is selected, click Add New.

The Add New RSLinx Driver dialog box will appear.

7. Create a name for the new driver (for example, 1203-USB) or use the default name.
8. Click OK.

The Configure RS-232 DF1 Devices dialog box appears.



Important: Do **not** click Auto-Configure because it will not work with the 1203-USB converter. Sometimes clicking Auto-Configure will break the driver. If Auto-Configure was unintentionally clicked, it is best to delete the driver and start over with step 5 above.

9. Enter the following settings.

Configuration Field	Setting
Comm Port	Select the same COM port established during installation of the 1203-USB driver (noted in step 1 on page 3-2). For this example, COM5 is used.
Device	1770-KF2/1785-KE/SCANport
Baud Rate	115200
Station Number	00 (default)
Parity	None (default)
Error Checking	BCC (default)
Stop Bits	1 (default)
Protocol	Full Duplex (default)

10. Click OK.

The Configure Drivers dialog box appears.

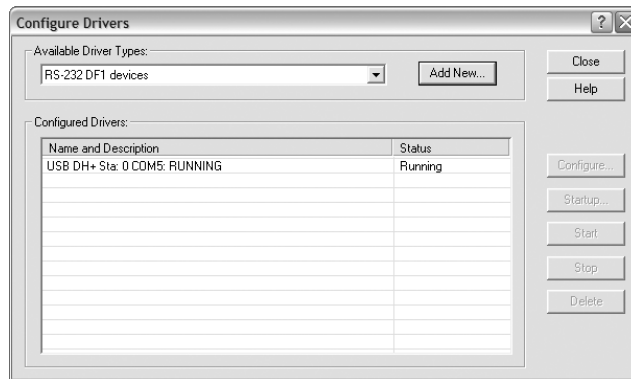

11. Verify that the status of the newly created driver is 'Running'.
12. Click Close.
13. From the Communications menu, choose RSWho to display the browse window.
14. Expand the treeview in the left pane to display the 'DPI' or 'DSI' icon to verify that the driver is communicating with the device.

Depending on the type of drive to which the 1203-USB converter is connected, the converter will show up as either a DSI device (DSI icon) or DPI device (DPI icon). The browse window should look similar to this example window.



15. Launch Connected Components Workbench software to access parameters in the 1203-USB converter, the connected drive, and any connected peripherals.
16. In the Device Toolbox right pane, select Discover and click Browse Connections.

The Connection Browser appears. The following example image shows the 1203-USB is connected to a DSI device.

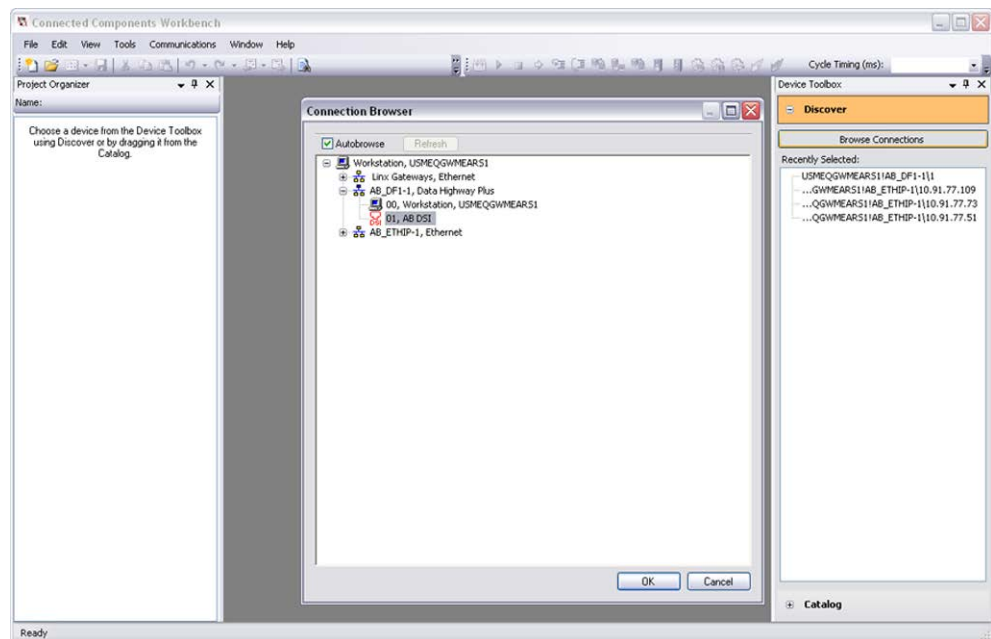

17. Expand the treeview if necessary and select the AB DSI (or AB DPI) icon.
18. Click OK.

Connected Components Workbench software will connect to the device, create any database files if needed (for later use when offline), add the device to the Project Organizer left pane, and open the Device Details window for the device.

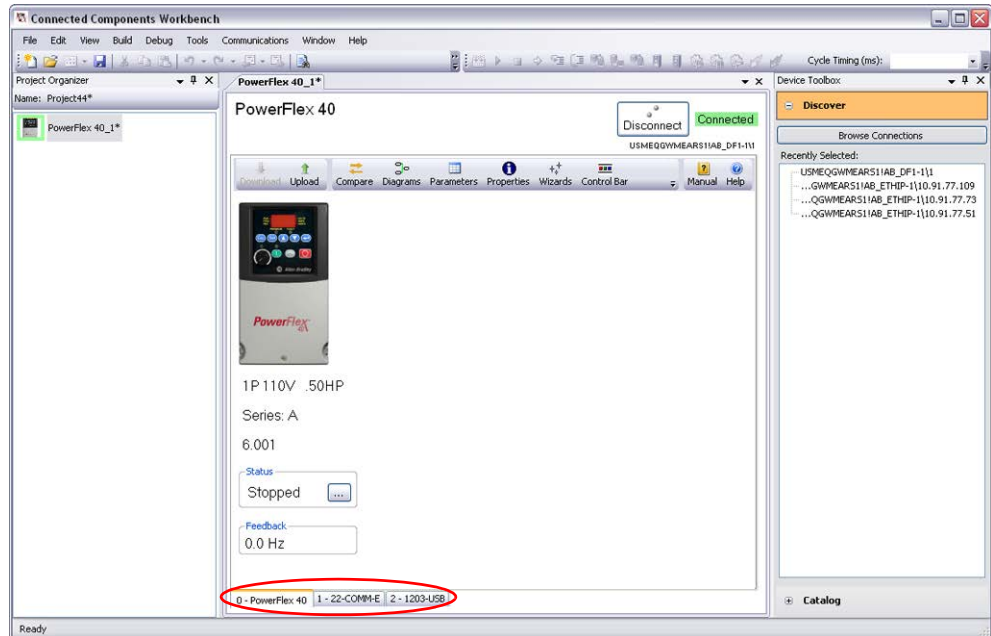

The example image above shows the 1203-USB converter is connected to a PowerFlex 40 drive that also has a 22-COMM-E option installed.

19. Select the 1203-USB tab at the bottom of the Device Details window to view the 1203-USB converter.

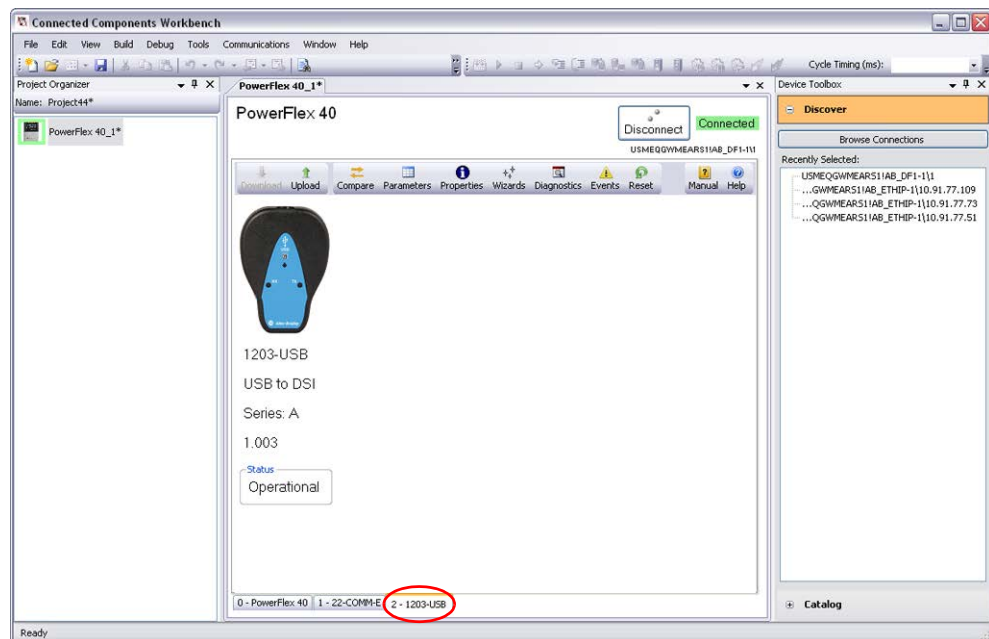

20. Click the Parameters icon  to open the Linear List parameter editor.

The screenshot shows a software window titled "Parameters - PowerFlex 40_1* Port 2". It contains a table with the following data:

#	Name	Value	Units	Internal Value	Default
* 1	Adapter Cfg	Auto		0	Auto
* 2	Reset Module	Ready		0	Ready
* 3	Clear DF1 Counts	Ready		0	Ready
* 4	DF1 Packets Sent	6203		6203	0
* 5	DF1 Packets Rcvd	6205		6205	0
* 6	RTU DSI Addr Cfg	1		1	1
* 7	RTU DSI Addr Act	1		1	1
* 8	Adapter Type	Slave		1	Master

21. To edit a parameter, either make the changes directly in the grid or double-click the parameter to open a parameter editor window.
22. Close the window when finished.

Resetting the Converter

Changes to settings of some 1203-USB converter parameters require that you reset the converter before the new settings take effect. You can reset the converter by cycling power to the drive or by using converter **Parameter 02 - [Reset Module]**.



ATTENTION: Risk of injury or equipment damage exists. If the converter is transmitting control I/O to the drive (indicated by a solid green diamond LED), the drive may fault when you remove or reset the converter. Determine how your drive will respond before removing or resetting a connected converter.

Set converter **Parameter 02 - [Reset Module]** to '1' (Reset Module).

When you enter '1' (Reset Module), the converter will be immediately reset. When you enter '2' (Set Defaults), the converter will set all converter parameters to their factory-default values. After performing a Set Defaults, you must enter '1' (Reset Module) or power cycle the converter so that the new values take effect. Thereafter, this parameter will be restored to a value of '0' (Ready).

Updating the Firmware

Connected Components Workbench is not intended to be used as a firmware update tool. The recommended tool to use is ControlFLASH software, which is downloaded automatically when the respective firmware revision file is downloaded from the Allen-Bradley updates website to your computer.

DriveExplorer, DriveExecutive, or HyperTerminal software can also be used to perform firmware updates on the 1203-USB converter and products that implement DPI or DSI, such as PowerFlex 7-Class drives and peripherals, or PowerFlex 4-Class peripherals. When using one of these tools to update the firmware, see the respective appendix in this manual for details.

Important: PowerFlex 400 drives can only be updated using a AK-U9-FLSH1 flash kit. PowerFlex 4, 40, and 40P drives cannot be updated. Only PowerFlex 4M drives can be updated using the 1203-USB converter.

Important: DriveExplorer or DriveExecutive software cannot be used to update products that support SCANport.

Using RTU Master Mode for a Serial Multi-drop Network

With the converter in RTU Master mode, you can monitor, configure, and control up to 32 DSI drives.



TIP: A total of 247 drives can be supported on the RTU Master network when RS-485 repeaters are installed.

Important: All PowerFlex 4-Class drives on an RTU Master network must have an open internal Port 1. Thus, a 22-COMM-* adapter cannot be connected to this port through the Internal Interface ribbon cable.

Important: All PowerFlex 520-Series drives on an RTU Master network must not have a DSI communication option installed or connected (only the 1203-USB converter can be connected).

When a drive faults in an RTU Master network, all other drives remain operational and unaffected.

Network Wiring

See [Figure 3.1](#) for a network wiring example to wire an RTU Master network.

1. Connect the first DSI drive (Drive 1) on the network to the 1203-USB converter using an AK-U0-RJ45-SC1 splitter cable.
 - a. Plug the male end of the splitter cable into Port 2 on the bottom of the drive.

- b. Connect the 1203-USB converter to the Master port (identified by the letter 'M' at the port) of the splitter cable.

Important: Only one splitter cable can be used on the network, and it must be used to connect the 1203-USB converter to the first drive.

2. Using a 22-RJ45CBL-Cxx communications cable, or an appropriate twisted pair cable with two connectors (Figure 3.2) from an AK-U0-RJ45-TB2P kit, insert the connector from one end of the cable into the splitter cable Slave port (identified by the letter 'S' at the port).
3. Insert the connector on the other end of the cable into Port 2 on the bottom of the second drive (Drive 2).

Figure 3.1 Wiring Example for RTU Master Network

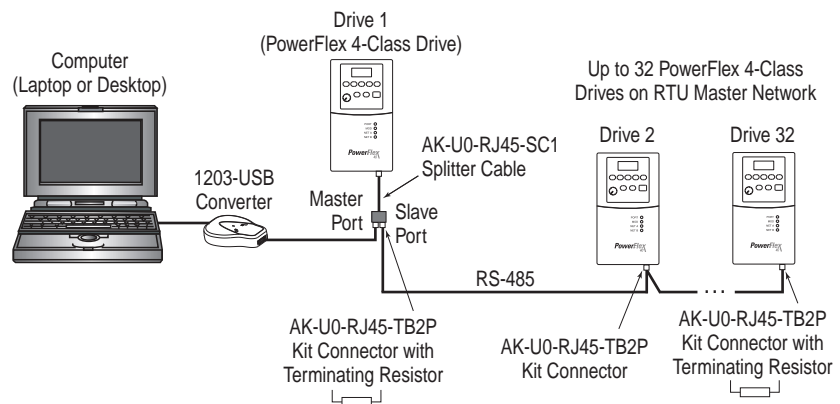

For all subsequent DSI drives—up to 32 drives total on the RTU Master network—daisy chain them together using the same method, type of cable, and terminal connectors connected into Port 2 on the bottom of each respective drive.

The AK-U0-RJ45-TB2P kit contains 6 two-position terminal block connectors (Figure 3.2). These connectors can be used to conveniently daisy chain the DSI drives from Drive 1, which is connected to the 1203-USB converter. Two terminating resistors are also included with the AK-U0-RJ45-TB2P kit and must be used on the connection to the first and last drives on the network.

Figure 3.2 AK-U0-RJ45-TB2P Kit Terminal Block Connector

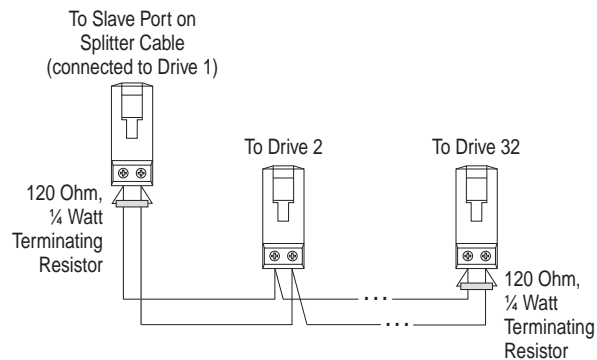

Figure 3.3 shows a wiring diagram for using AK-U0-RJ45-TB2P terminal block connectors and the two terminating resistors.

Figure 3.3 Connector Wiring Diagram

Establishing Communication

Establish communication between the drive connected to the 1203-USB converter and the computer.

Configuring the Drive Parameters

When setting drive parameters for the functions listed in the following subsections to enable operation on an RTU Master serial multi-drop network, use any of the following tools:

- The integral keypad on each DSI drive (if available)
- The 1203-USB converter and Connected Components Workbench software

When using the converter, electrically connect the converter to the computer and the first drive, establish communication with the drive, and use a drive software tool to set its parameters. Then electrically connect the converter to the next drive and repeat the process until the parameters in all of the drives have been set.

Setting Comm Data Rates

For each drive to be networked, including Drive 1 connected to the 1203-USB converter, use the following drive parameter and value to set the communication data rate to 19.2K baud.

- PowerFlex 4-Class drives: Parameter 103 [Comm Data Rate] = '4'
- PowerFlex 520-Series drives: Parameter 123 [RS485 Data Rate] = '4'

Setting Drive Addresses

1. For Drive 1 connected to the 1203-USB converter, use the following drive parameter to set the drive's RS485 node address to match the converter node address (default = 1 and set with converter **Parameter 06 - [RTU DSI Addr Cfg]**).

- PowerFlex 4-Class drives: Parameter 104 [Comm Node Addr]
- PowerFlex 520-Series drives: Parameter 124 [RS485 Node Addr]

Important: When setting the 1203-USB converter node address, do not use a value higher than ‘77’ octal.

2. For each remaining drive to be networked, set the drive’s RS485 node address to a unique address.

Setting Comm Loss Action

For each drive to be networked, including Drive 1 connected to the 1203-USB converter, use the following drive parameter to set the drive’s communication loss action to either ‘1’ (Coast to Stop) or ‘2’ (Stop).

- PowerFlex 4-Class drives: Parameter 105 [Comm Loss Action]
- PowerFlex 520-Series drives: Parameter 125 [RS485 Loss Action]

Power Cycle All Drives

Power cycle each drive so that all new settings established in this section will take effect.

For convenience, use the following blank table to note the settings for each drive to be networked.

Network Drive No.	RS485 Node Address Setting for Drive	Comm Loss Action Setting for Drive
1		
2		
3		
4		
5		
6		
7		
8		
9		
10		
11		
12		
13		
14		
15		
16		

Network Drive No.	RS485 Node Address Setting for Drive	Comm Loss Action Setting for Drive
17		
18		
19		
20		
21		
22		
23		
24		
25		
26		
27		
28		
29		
30		
31		
32		

Configuring the Converter for RTU Master Mode

Set 1203-USB converter **Parameter 01 - [Adapter Cfg]** to a value of ‘3’ (RTU Master) and reset or cycle power to the converter.

Configuring RSLinx for Serial Multi-Drop System

The Configured Driver in RSLinx is slightly different when configuring for a RS-485 multi-drop system as opposed to a point-to-point system (single drive).

1. Open RSLinx software.
2. From the Communications menu, choose Configure Drivers.



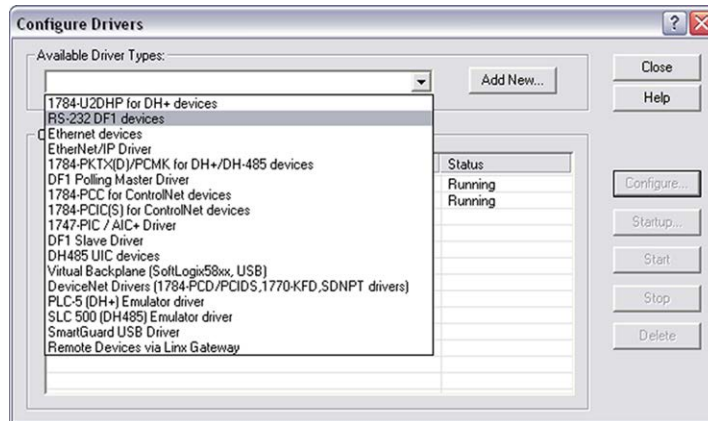

3. From the Available Driver Types pull-down menu, choose RS-232 DF1 devices.

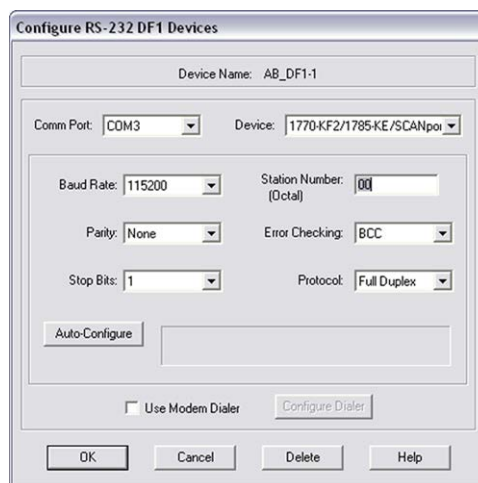

4. Click Add New and enter a name.
5. Enter all settings as shown in the following image.

The Comm Port address will vary depending on the port that gets assigned to the 1203-USB converter. In this example, the 1203-USB converter is connected to COM3.



6. Click OK.
7. Click the RSWho icon  to open the RSWho window.
8. Right-click the serial drive that you just added and select Properties.

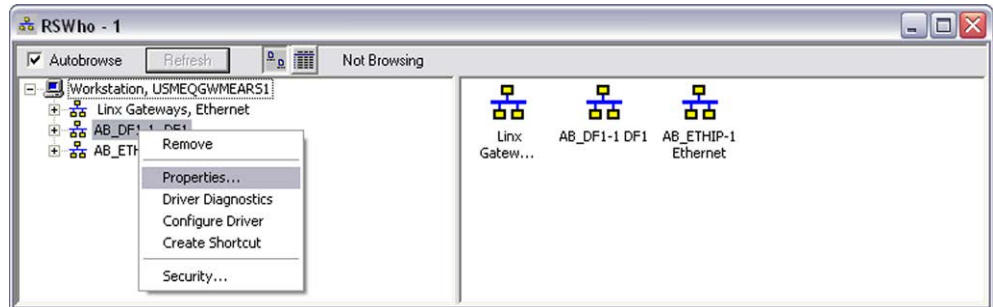

9. On the Browse Addresses tab, check 'Browse only the specified addresses'.

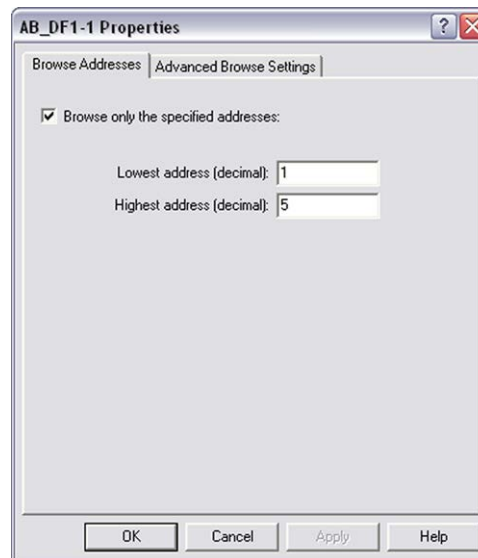

10. Enter the lowest and highest RTU node addresses in your system.

In the previous example image, there are five drives in the system with node addresses 1 through 5.

11. On the Advance Browse Settings tab, check 'Force network type to'.

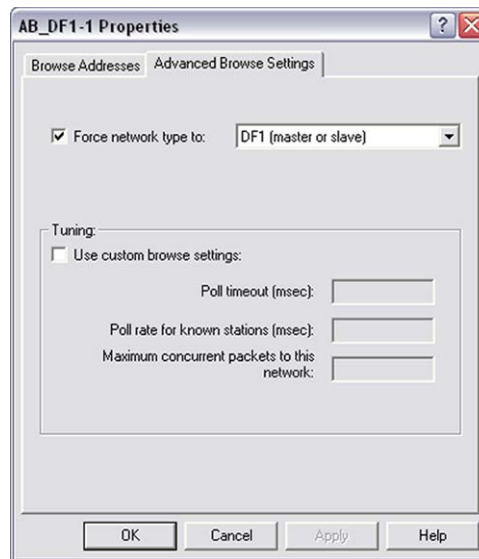

12. From the pull-down menu, choose DF1 (master or slave).
13. Click OK.
14. Close RSLinx software.

Accessing Drives on the RTU Master (Serial Multi-drop) Network

Connected Components Workbench software enables you to monitor, configure, and control any of the drives on the RTU Master (serial multi-drop) network. You can also monitor and configure the 1203-USB converter.

1. In the Device Toolbox right pane, select Discover and click Browse Connections to open the Connection Browser.

The serial driver should show all of the drives that are powered up on the serial network. The image below shows five DSI drives on the multi-drop network.

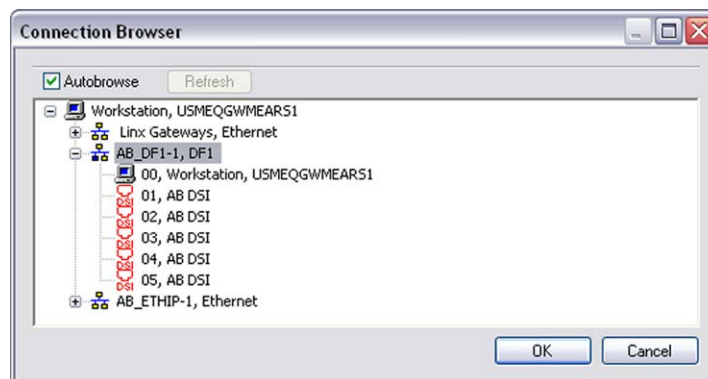

If you do not see all of your drives on the network:

- Make sure the drives are powered up.
- Verify the COM port to which the 1203-USB converter is assigned.

- Recheck your RSLinx driver settings.
 - Recheck your wiring.
2. Click on a drive to connect to it and have it added to the Project Organizer left pane.

The example image below shows all five drives in the serial multi-drop system connected online and present in the Project Organizer.

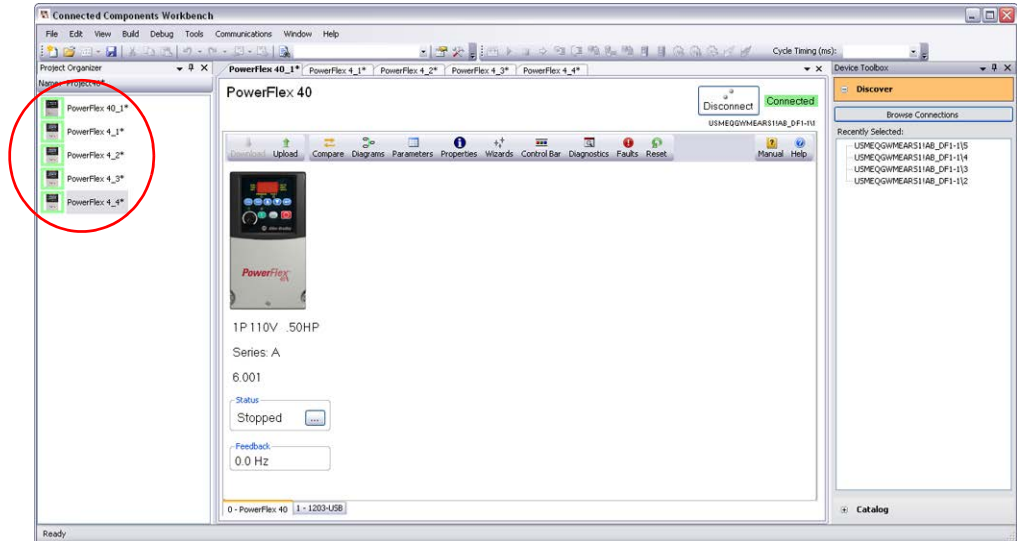

3. From the File menu, choose Save to save the project.

Saving the project will provide an opportunity to upload and save all of the drives at once.

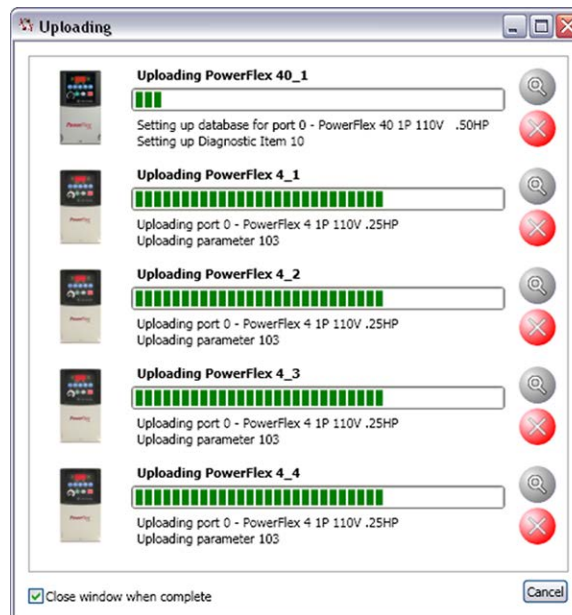

Your serial multi-drop system is now saved in your project.

Notes:

Troubleshooting

This chapter provides information for diagnosing and troubleshooting potential problems with the 1203-USB converter.

Topic	Page
Understanding the Status Indicators	4-1
Diamond Status Indicator	4-2
RX Status Indicator	4-2
TX Status Indicator	4-2
Converter Diagnostic Items	4-3
Viewing Diagnostic Data	4-4
Converter Events	4-6
Viewing and Clearing Events	4-8
Viewing and Clearing DF1 Communication Statistics	4-9
Troubleshooting Potential Problems	4-10

Understanding the Status Indicators

The converter has three status indicators to report its operating status.

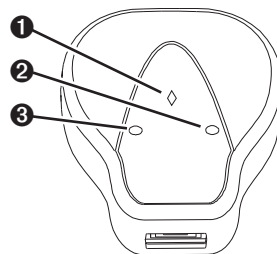

Item	Status Indicator	Description	Page
❶	Diamond	Status of converter.	4-2
❷	TX	Converter is transmitting data.	4-2
❸	RX	Converter is receiving data.	4-2

Diamond Status Indicator



ATTENTION: Risk of injury or equipment damage exists. If the converter is transmitting control I/O to the drive (indicated by a steady green diamond status indicator), the drive may fault when you remove or reset the converter. Determine how your drive will respond before removing or resetting a converter.

Status	Cause	Corrective Action
Off	Converter is not powered, or is in Flash programming mode.	<ul style="list-style-type: none"> Securely connect cables. Apply power to the drive. Wait until Flash update is completed.
Flashing Green	Converter is operating and not transmitting control I/O.	No action required. Removing or resetting the converter will not cause a fault in the drive.
Steady Green	Converter is operating and is or was transmitting control I/O.	<p>No action required. Removing or resetting the converter will cause a fault in the drive.</p> <p>For DPI drives only, a 'Soft Logout' can be performed to allow removal of the converter without a fault occurring. To do this, set the logic mask in the drive to ignore the converter and then verify that the drive is receiving its Logic Command and Reference from another source.</p>
Flashing Red	The drive has not acknowledged the converter.	<ul style="list-style-type: none"> Securely connect cables. DPI or SCANport Drives: Verify that converter Parameter 06 - [Interface Mode] is set to '0' (Auto). DSI Drives: Verify that converter Parameter 01 - [Adapter Cfg] is set to '0' (Auto).
	The drive was disconnected from the computer, or the computer was turned off.	<ul style="list-style-type: none"> Securely connect cables. Turn on the computer.
Steady Red	Link failure.	<ul style="list-style-type: none"> Securely connect cables. Replace the cable. Cycle power to the drive.

RX Status Indicator

Status	Cause	Corrective Action
Off	Converter is not receiving data.	<ul style="list-style-type: none"> Verify that data is being transmitted by the computer. Securely connect cables. Apply power to the drive. Configure the computer software to use the same port rate as the converter.
Flashing Green	Converter is receiving data from the computer.	No action required.

TX Status Indicator

Status	Cause	Corrective Action
Off	Converter is not transmitting data.	<ul style="list-style-type: none"> Verify that data is being transmitted. Securely connect cables. Apply power to the drive.
Flashing Green	Converter is transmitting data to the computer.	No action required.

Converter Diagnostic Items

If you encounter unexpected communication problems, the converter diagnostic items may help you or Allen-Bradley personnel troubleshoot the problem. Converter diagnostic items can be viewed with Connected Components Workbench software, version 1.02 or later.

Diagnostic Items for DPI Drives

No.	Name	Description
1	Common Logic Cmd	Present value of the Common Logic Command being transmitted to the drive by the converter.
2	Prod Logic Cmd	Present value of the Product Specific Logic Command being transmitted to the drive by the converter.
3	Reference	Present value of the Product Specific Reference being transmitted to the drive by the converter.
4	Common Logic Sts	Present value of the Common Logic Status being received from the drive by the converter.
5	Prod Logic Sts	Present value of the Product Specific Logic Status being received from the drive by the converter.
6	Feedback	Present value of the Product Specific Feedback being received from the drive by the converter.
7	DPI Rx Errors	Present value of the DPI CAN Receive Error Counter register.
8	DPI Rx Error Max	Maximum value of the DPI CAN Receive Error Counter register.
9	DPI Tx Errors	Present value of the DPI CAN Transmit Error Counter register.
10	DPI Tx Error Max	Maximum value of the DPI CAN Transmit Error Counter register.
11	Field Flash Cntr	Present value of the Field Flash Counter.

Diagnostic Items for DSI Drives

No.	Name	Description
1	Field Flash Cnt	Number of times the module has been Field Flashed.
2	Adapter Events	Number of events in the event queue.
3	Reference	Present value of the Reference being transmitted to the drive by the converter.
4	Logic Cmd	Present value of the Logic Command being transmitted to the drive by the converter.
5	Logic Sts	Present value of the Logic Status being received from the drive by the converter.
6	Feedback	Present value of the Feedback being received from the drive by the converter.
7	Clear DSI Counts	Clears the DSI counters.
8	DSI Packets Sent	DSI (Modbus) packets sent by the converter.
9	DSI Packets Rcvd	DSI (Modbus) packets received by the converter.
10	DSI Bad Packet	DSI packets received with a bad Cyclic Redundancy Check (CRC).
11	DSI Retries	Number of times a DSI received no response and was re-sent.

Diagnostic Items for SCANport Drives

Diagnostic items are not supported by SCANport drives.

Viewing Diagnostic Data

1. Connect online with a drive and display the Device Details window for the 1203-USB converter.

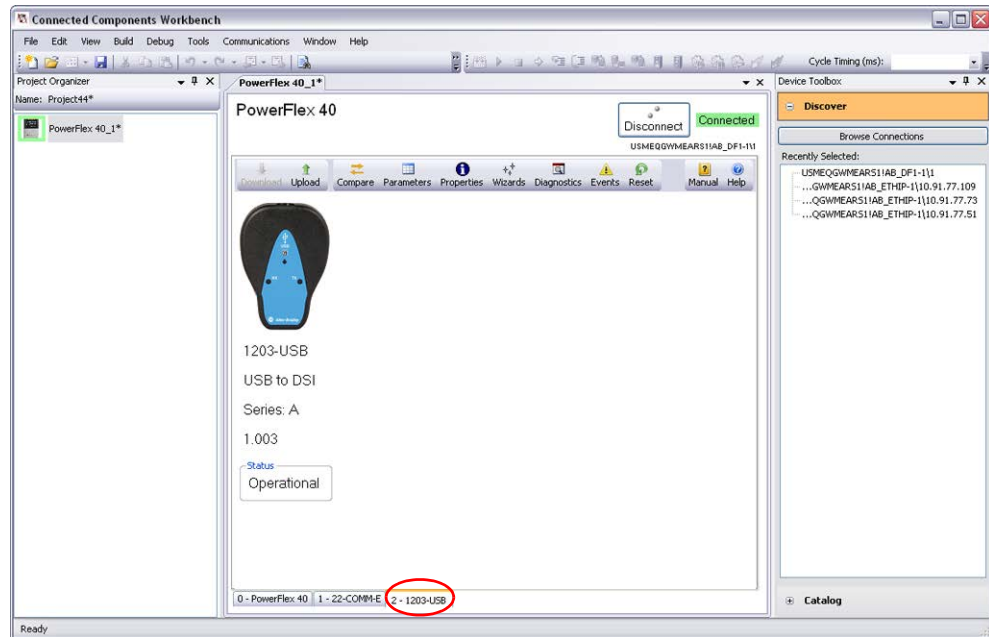

2. Click the Diagnostics icon  to open the Diagnostics window.

The example image below is for a 1203-USB converter when connected to a DSI-based host product (PowerFlex 40).

#	Name	Value	Units	Internal Value	Default
1	Field Flash Cnt	2		2	0
2	Adapter Events	1		1	0
3	Reference	0.00	Hz	0	0.00
4	Logic Cmd	00000000 ...		0	00000000 000...
5	Logic Sts	000001100 ...		1549	00000000 000...
6	Feedback	0.00	Hz	0	0.00
7	Clear DSI Counts	Ready		0	Ready
8	DSI Packets Sent	6262		6262	0
9	DSI Packets Rcvd	25123		25123	0
10	DSI Bad Packet	0		0	0
11	DSI Retries	0		0	0

When communicating, Diagnostic Item #8 (DSI Packets Sent) and Diagnostic Item #9 (DSI Packets Rcvd) should be incrementing. Ideally, Diagnostic Item #10 (DSI Bad Packet) and Diagnostic Item #11 (DSI Retries) should have zero counts.

3. To clear the various diagnostic counters, set Diagnostic Item # 7 (Clear DSI Counts) to 'Clear Counts'.
4. Press Enter.

Another example image below is for a 1203-USB converter when connected to a DPI-based host product (PowerFlex 70EC).

#	Name	Value	Units	Internal Value	Default
1	Common Logic Cmd	2		2	0
2	Prod Logic Cmd	00000000 0...		0	00000000 0000...
3	Reference	0		0	0
4	Common Logic Sts	01000100 0...		17501	00000000 0000...
5	Prod Logic Sts	00001010 0...		2573	00000000 0000...
6	Feedback	0		0	0
7	DPI Rx Errors	0		0	0
8	DPI Rx Error Max	255		255	0
9	DPI Tx Errors	0		0	0
10	DPI Tx Error Max	255		255	0
11	Field Flash Cnt	5		5	0

Diagnostic Item #7 (DPI RX Errors) and Diagnostic Item #8 (DPI TX Errors) should have zero counts.

Converter Events

Many events in the event queue occur under normal operation. If you encounter unexpected communication problems, the events may help you or Allen-Bradley personnel troubleshoot the problem. Converter events can be viewed with Connected Components Workbench software, version 1.02 or later.

Event Codes for DPI Drives

Code	Events	Description
1	No Event	No event present in the event queue.
2	DPI Bus Off Flt	A bus-off condition was detected on DPI. This event may be caused by loose or broken cables, or by noise.
3	Ping Time Flt	A ping message was not received on DPI within the specified time.
4	Port ID Flt	The converter is not connected to a correct port on a DPI drive.
5	Port Change Flt	The DPI port changed.
6	Host Sent Reset	The DPI drive issued this because it was reset.
7	EEPROM Sum Flt	The EEPROM in the converter is corrupt.
8	Online @ 125kbps	The converter and DPI drive are communicating at 125kbps.
9	Online @ 500kbps	The converter and DPI drive are communicating at 500kbps.
10	Bad Host Flt	
11	Dup Port Flt	Another peripheral with the same port number is already in use.
12	Type 0 Login	The converter has logged in for type 0 control.
13	Type 0 Time Flt	The converter has not received a type 0 status message within the specified time.
14	DL Login	
15	DL Reject Flt	
16	DL Time Flt	
17	Reserved	—
18	Control Disabled	The converter has sent a 'Soft Control Disable' command to the DPI drive.
19	Control Enabled	The converter has sent a 'Soft Control Enable' command to the DPI drive.
20	PCCC I/O Time Flt	The converter has not received a PCCC Control message for longer than the specified PCCC Control Time-out.
21	Normal Startup	The converter initially powered up or was reset.
22	Message Timeout	The DPI drive did not respond to a message request. Verify that cabling is correct.
23	Ping in Message	An unexpected ping was received.
24	DPI Fault Msg	The drive entered a faulted state.
25	DPI Fault Clear	A DPI drive has issued a fault clear message.
26	Manual Reset	

Event Codes for DSI Drives

Code	Event	Description
F0	No Event	No event present in the event queue.
F1	Adapter Reset	The converter was reset by the user.
F2	Slave Detected	A slave was detected to be present by the master.
F3	Slave Removed	A slave was detected to be removed by the master.
F4	Host Timeout	A timeout condition on Msg to Host.
F5	Slave Timeout	A timeout condition on Msg to Slave.
F6	Master Timeout	A timeout condition on Msg to Master.
F7	Serial Timeout	A timeout on Serial 232 side (with control enabled).
F8	Control Enabled	The converter has sent a 'Soft Control Enable' command to the drive.
F9	Control Disabled	The converter has sent a 'Soft Control Disable' command to the drive.
F10	EEPROM Sum Fit	Startup sequence detected corrupt EEPROM storage in the converter.

Event Codes for SCANport Drives (DriveExplorer or DriveExecutive software only)

Events	Description
Adapter Reset	The converter was reset or power cycled.
Clear SP Fault	The SCANport drive issued this because a fault was cleared in it.
Clear SP Warning	The SCANport drive issued this because a warning was cleared.
Empty Queue	The queue does not contain any recorded events.
Message Timeout	The SCANport drive did not respond to a message request. Verify that cabling is correct.
No SCANport Ping	The converter issued this because no SCANport pings were detected within a 2 second period. This event may be caused by a disconnected or broken cable, a broken converter, or a malfunction in the SCANport drive.
Pin ID Change	The converter issued this because the SCANport Pin ID was changed. This event is normal after a power cycle or reset.
SCANport Bus Off	The converter issued this because its SCANport CAN chip went bus off. This event may be caused by loose or broken cables, or by noise.
SCANport Fault	The SCANport drive issued this because it was faulted. See its fault queue.
SCANport Reset	The SCANport drive issued this because it was reset.
SCANport Warning	The SCANport drive issued this because it had a warning.
SP Pin ID = 7	The converter issued this because its Pin ID has a value of 7. It should have a value between 1 and 6. This event may be caused by a loose or broken cable.

Viewing and Clearing Events

The 1203-USB converter maintains an event queue that reports the history of its actions. The event queue can only be accessed when online with the converter.

1. Connect online with a drive and display the Device Details window for the 1203-USB converter.

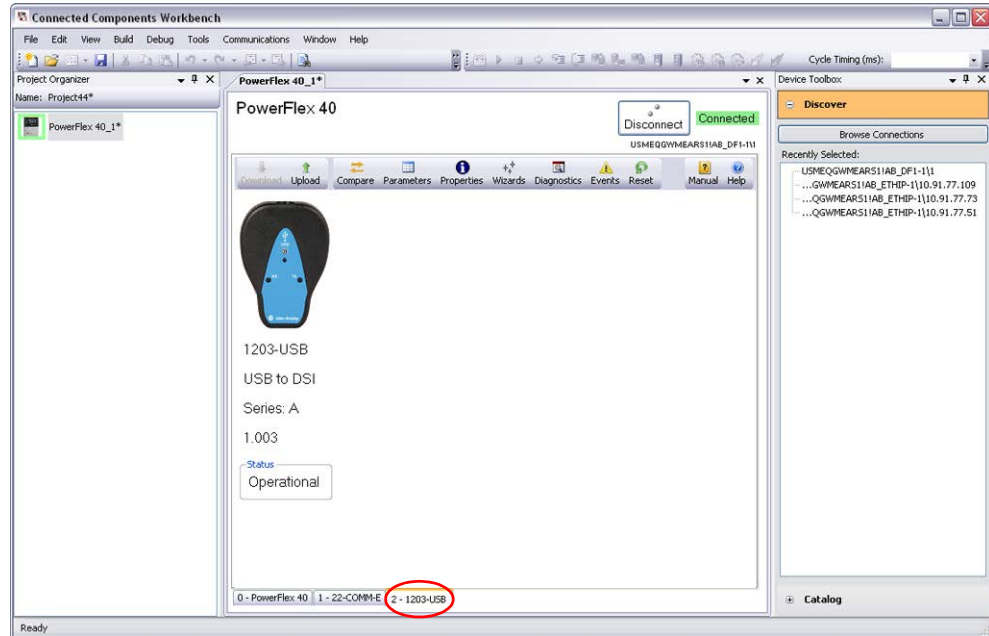

2. Click the Events icon  to open the events window.

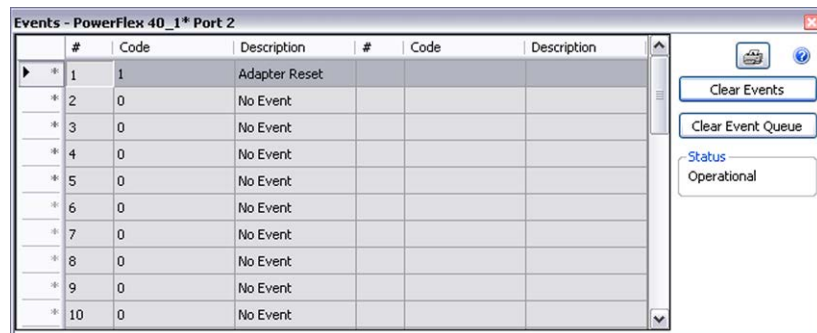

The most recent event is stored in Event #1.

To clear the most recent event, click Clear Event. To clear the entire queue, click Clear Event Queue.

Viewing and Clearing DF1 Communication Statistics

If you encounter unexpected communication problems or are creating an application that uses DF1 data, you can view the communication statistics stored in the converter.

1. Connect online with a drive and display the Device Details window for the 1203-USB converter.

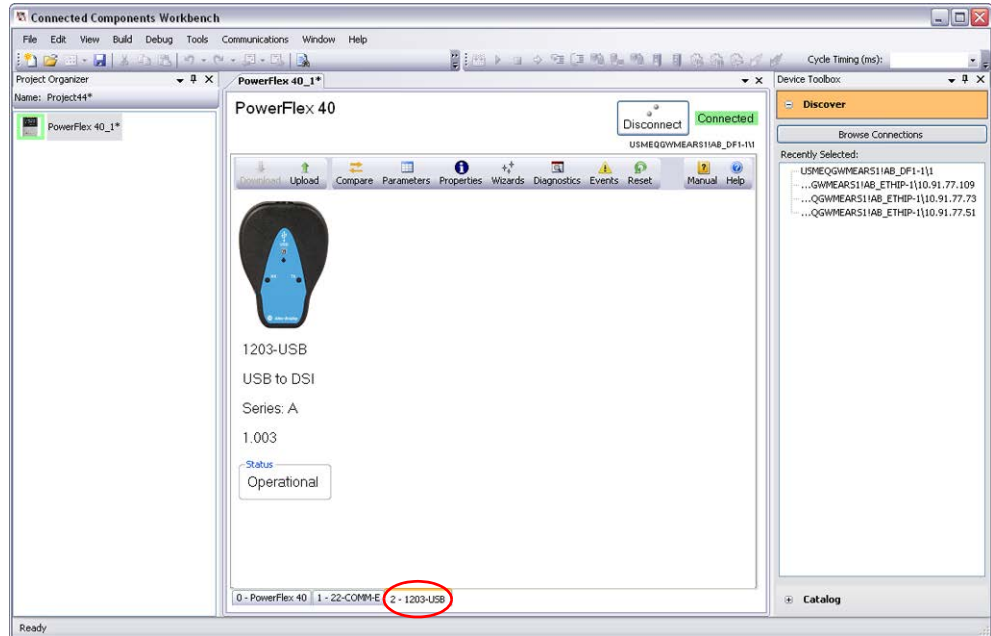

2. Click the Parameters icon  to open the Linear List parameter editor.

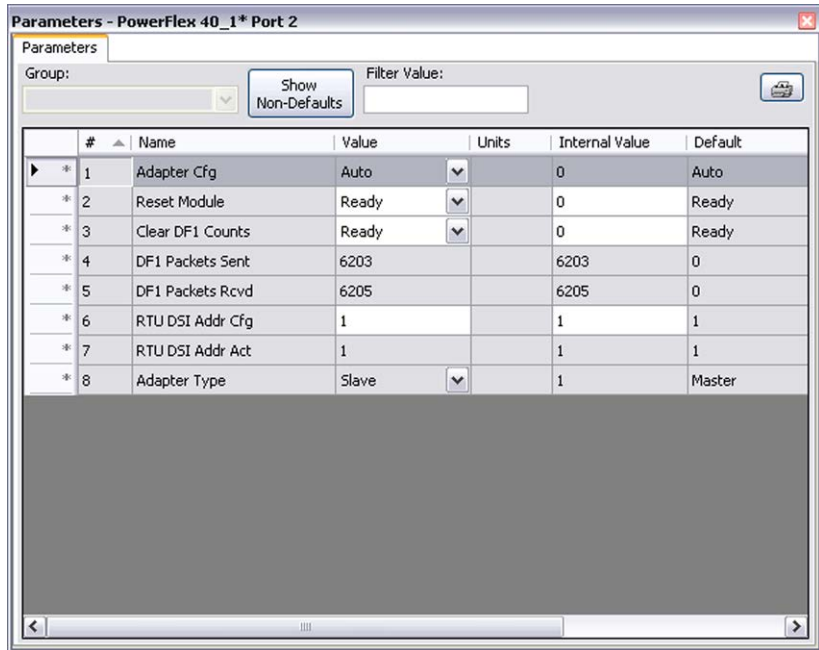

3. Converter **Parameters 04 - [DF1 Packets Sent]** and **05 - [DF1 Packets Rcvd]** count the DF1 packets being transmitted and received. Both should be incrementing and at approximately the same values.

4. To clear the DF1 counters, set converter **Parameter 03 - [Clear DF1 Counts]** to '1' (Clear Counts).
5. Press Enter.

Troubleshooting Potential Problems

This section provides information about common converter problems and actions that can be taken to correct them.

Unable to Establish Connection Between the Computer and Converter

- If the 1203-USB converter status indicators are off, connect the converter cables and apply power to the drive. The converter draws its power from the drive.
- Configure RSLinx to use the correct virtual COM port and baud rate. See [page 3-2](#) for the virtual COM port. The only baud rate that works is 115200.

No Communication to the Drive

- When connected to DPI-based drives, verify that converter **Parameter 06 - [Interface Mode]** is set to '0' (Auto).
- When connected to DSI-based drives, verify that converter **Parameter 01 - [Adapter Cfg]** is set to '0' (Auto).

Cannot Communicate with a SCANport-based Drive

Connected Components Workbench software does not support SCANport-based devices. Use DriveExplorer or DriveExecutive software for these devices.

Specifications

This appendix presents the specifications for the 1203-USB converter.

Topic	Page
Communications	A-1
Electrical	A-1
Mechanical	A-1
Environmental	A-2
Agency Certification	A-2

Communications

Network side	
Protocol	Universal Serial Bus (USB)
Port Rate	115.2 kbps
Data Bits	8
Parity	None
Stop Bits	1
Flow Control	None
Error	CRC or BCC (Auto-Detected)
Drive side	
Protocol	DPI, DSI, or SCANport
DPI Data Rate	125 Kbps or 500 Kbps
DSI Data Rate	19.2 Kbps
SCANport Data Rate	125 Kbps

Electrical

Consumption	
DPI or SCANport Drive	130 mA at +12V DC
DSI Drive	170 mA at +5V DC
	The converter draws the required power from the connected drive. An external power source is not required.

Mechanical

Dimensions	
Height	103.5 mm (4.08 inches)
Width	73.4 mm (2.89 inches)
Depth	23.6 mm (0.93 inches)
Weight	70.88 g (2.5 oz.)

Environmental

Temperature Operating Storage	0...50 °C (32...122 °F) -40...85 °C (-40...185 °F)
Relative Humidity	5...95% non-condensing
Atmosphere	Important: The converter must not be installed in an area where the ambient atmosphere contains volatile or corrosive gas, vapors or dust. If the converter is not going to be installed for a period of time, it must be stored in an area where it will not be exposed to a corrosive atmosphere.
Vibration Operating Non-Operating	2.5 G @5Hz-2KHz 5 G @5Hz-2KHz
Shock Operating Non-Operating	30 G peak acceleration, 11 (±1) ms pulse width 50 G peak acceleration, 11 (±1) ms pulse width

Agency Certification

UL	UL508C
cUL	CAN / CSA C22.2 No. 14-M91
CE	EN50178 and EN61800-3
CTick	AS / NZS 2064, Group 1, Class A

Important: For the converter to be CE and CTick compliant when connected to a DSI (PowerFlex 4-Class) drive, the shield of the drive cable must be terminated as described in the Important statements on [page 2-3](#).

NOTE: This is a product of category C2 according to IEC 61800-3. In a domestic environment this product may cause radio interference in which case supplementary mitigation measures may be required.

Converter Parameters

This appendix provides information about the 1203-USB converter parameters. The 1203-USB converter (DPI, DSI, and SCANport) combines the functionality of the 1203-SSS converter (DPI and SCANport) and 22-SCN-232 converter (DSI) in a single device.



TIP: The 1203-USB converter automatically detects the type of device (DPI, DSI, or SCANport) to which it is connected, and provides a corresponding set of parameters that are appropriate for the device.

Topic	Page
Parameters – DPI Drives	B-1
Parameters – DSI Drives	B-2
Parameters – SCANport Drives (DriveExplorer or DriveExecutive software only)	B-4

Parameters – DPI Drives

No.	Name and Description	Details
01	[DPI Port] Displays the port on the host drive to which the converter is connected.	Default: 0 Minimum: 0 Maximum: 7 Type: Read Only
02	[Reset Module] No action if set to '0' (Ready). Resets the converter if set to '1' (Reset Module). Restores the converter to its factory default settings if set to '2' (Set Defaults). This parameter is a command. It will be reset to '0' (Ready) after the command has been performed.	Default: 0 = Ready Values: 0 = Ready 1 = Reset Module 2 = Set Defaults Type: Read/Write Reset Required: No
 <p>ATTENTION: Risk of injury or equipment damage exists. If the converter is transmitting I/O that controls the drive (indicated by a steady green diamond status indicator), the drive may fault when you remove or reset the converter. Determine how your drive will respond before removing or resetting a connected converter.</p>		
03	[Clear DF1 Counts] No action if set to '0' (Ready). Resets the DF1 statistical Parameter 04 - [DF1 Packets Sent] and Parameter 05 - [DF1 Packets Rcvd] to 0 (zero) if set to '1' (Clear Counts). This parameter is a command. It will be reset to '0' (Ready) after a '1' (Clear Counts) command has been performed.	Default: 0 = Ready Values: 0 = Ready 1 = Clear Counts Type: Read/Write Reset Required: No
04	[DF1 Packets Sent] Displays the number of DF1 packets sent by the converter. The value of this parameter is normally approximately equal to the value of Parameter 05 - [DF1 Packets Rcvd] .	Default: 0 Minimum: 0 Maximum: 4294967295 Type: Read Only

No.	Name and Description	Details
05	<p>[DF1 Packets Rcvd] Displays the number of DF1 packets received by the converter. The value of this parameter is normally approximately equal to the value of Parameter 04 - [DF1 Packets Sent].</p>	Default: 0 Minimum: 0 Maximum: 4294967295 Type: Read Only
06	<p>[Interface Mode] Sets the interface operating mode.</p> <p>Auto: The converter will automatically run DPI if connected to a DPI drive, or SCANport if connected to a SCANport legacy drive.</p> <p>SCANport: The converter will perform SCANport services only.</p> <p>Set this parameter to '0' (Auto, the default) unless you are using DriveTools32 software, version 2.xx, and you are connected to a DPI drive. In this case, use the '1' (SCANport) setting.</p>	Default: 0 = Auto Values: 0 = Auto 1 = SCANport Type: Read/Write Reset Required: Yes
07	<p>[DPI Data Rate] Displays the data rate used by the DPI host drive. This data rate is set in the drive, and the converter autobauds to it.</p>	Default: 0 Values: 0 = 125 kbps 1 = 500 kbps Type: Read Only
08	<p>[Ref/Fdbk Size] Displays the size of the Reference/Feedback. The host drive determines the size of the Reference/Feedback. The converter automatically uses the correct size.</p>	Default: 0 = 16-bit Value: 0 = 16-bit 1 = 32-bit Type: Read Only
09	<p>[Datalink Size] Displays the size of each Datalink word. The host drive determines the size of Datalinks.</p>	Default: 0 = 16-bit Values: 0 = 16-bit 1 = 32-bit Type: Read Only

Parameters – DSI Drives

No.	Name and Description	Details
01	<p>[Adapter Cfg] Sets the operation of the converter on DSI. Leave at the '0' (Auto) default setting when used with software tools point-to-point.</p>	Default: 0 = Auto Values: 0 = Auto 1 = Master 2 = Slave 3 = RTU Master 4 = RTU Passthru Type: Read/Write Reset Required: Yes
02	<p>[Reset Module] No action if set to '0' (Ready). Resets the converter if set to '1' (Reset Module). Restores the converter to its factory default settings if set to '2' (Set Defaults). This parameter is a command. It will be reset to '0' (Ready) after the command has been performed.</p>	Default: 0 = Ready Values: 0 = Ready 1 = Reset Module 2 = Set Defaults Type: Read/Write Reset Required: No
 <p>ATTENTION: Risk of injury or equipment damage exists. If the converter is transmitting I/O that controls the drive (indicated by a steady green diamond status indicator), the drive may fault when you remove or reset the converter. Determine how your drive will respond before removing or resetting a connected converter.</p>		

No.	Name and Description	Details
03	<p>[Clear DF1 Counts] No action if set to '0' (Ready). Resets the DF1 statistical Parameter 04 - [DF1 Packets Sent] and Parameter 05 - [DF1 Packets Rcvd] to 0 (zero) if set to '1' (Clear Counts). This parameter is a command. It will be reset to '0' (Ready) after the command has been performed.</p>	<p>Default: 0 = Ready Values: 0 = Ready 1 = Clear Counts Type: Read/Write Reset Required: No</p>
04	<p>[DF1 Packets Sent] Displays the number of DF1 packets sent by the converter. The value of this parameter is normally approximately equal to the value of Parameter 05 - [DF1 Packets Rcvd].</p>	<p>Default: 0 Minimum: 0 Maximum: 65535 Type: Read Only</p>
05	<p>[DF1 Packets Rcvd] Displays the number of DF1 packets received by the converter. The value of this parameter is normally approximately equal to the value of Parameter 04 - [DF1 Packets Sent].</p>	<p>Default: 0 Minimum: 0 Maximum: 65535 Type: Read Only</p>
06	<p>[RTU DSI Addr Cfg] Sets the node address of the converter for use with the converter operating mode set with Parameter 01 - [Adapter Cfg]. In Auto, Master, or Slave mode, the converter node address can be any valid value. In RTU Master or RTU Master Passthru mode, the converter node address must match the address of any drive on the network. Each network drive address must be unique. In any case, the RTU DSI address is a decimal value.</p>	<p>Default: 1 Minimum: 1 Maximum: 247 Type: Read/Write Reset Required: Yes</p>
07	<p>[RTU DSI Addr Act] Displays the node address of the drive that the converter is communicating with when the converter is set to RTU Master or RTU Passthru mode using Parameter 01 - [Adapter Cfg].</p>	<p>Default: 1 Minimum: 1 Maximum: 247 Type: Read Only</p>
08	<p>[Adapter Type] Displays the present operating mode for the converter.</p>	<p>Default: 0 = Master Values: 0 = Master 1 = Slave 2 = RTU Master 3 = RTU Passthru Type: Read Only</p>

Parameters – SCANport Drives (DriveExplorer or DriveExecutive software only)

No.	Name and Description	Details
01	[Adapter Port] Displays the port on the host drive to which the converter is connected.	Default: 0 Minimum: 0 Maximum: 7 Type: Read Only
02	[Reset Module] No action if set to '0' (Ready). Resets the converter if set to '1' (Reset Module). Restores the converter to its factory default settings if set to '2' (Set Defaults). This parameter is a command. It will be reset to '0' (Ready) after the command has been performed.	Default: 0 = Ready Values: 0 = Ready 1 = Reset Module 2 = Set Defaults Type: Read/Write Reset Required: No
 <p>ATTENTION: Risk of injury or equipment damage exists. If the converter is transmitting I/O that controls the drive (indicated by a steady green diamond status indicator), the drive may fault when you remove or reset the converter. Determine how your drive will respond before removing or resetting a connected converter.</p>		
03	[Clear DF1 Counts] No action if set to '0' (Ready). Resets the DF1 statistical Parameter 04 - [DF1 Packets Sent] and Parameter 05 - [DF1 Packets Rcvd] to 0 (zero) if set to '1' (Clear Counts). This parameter is a command. It will be reset to '0' (Ready) after a 'Clear Counts' command has been performed.	Default: 0 = Ready Values: 0 = Ready 1 = Clear Counts Type: Read/Write Reset Required: No
04	[DF1 Packets Sent] Displays the number of DF1 packets sent by the converter. The value of this parameter is normally approximately equal to the value of Parameter 05 - [DF1 Packets Rcvd] .	Default: 0 Minimum: 0 Maximum: 65535 Type: Read Only
05	[DF1 Packets Rcvd] Displays the number of DF1 packets received by the converter. The value of this parameter is normally approximately equal to the value of Parameter 04 - [DF1 Packets Sent] .	Default: 0 Minimum: 0 Maximum: 65535 Type: Read Only
06	[Interface Mode] Sets the interface operating mode. Auto: The converter will automatically run DPI if connected to a DPI drive, or SCANport if connected to a SCANport drive. SCANport: The converter will perform SCANport services only. Set this parameter to '0' (Auto, the default) unless you are using DriveTools32 software, version 2.xx, and you are connected to a DPI drive. In this case, use the '1' (SCANport) setting.	Default: 0 = Auto Values: 0 = Auto 1 = SCANport Type: Read/Write Reset Required: Yes

Use with DriveExplorer Software

This appendix presents information about using DriveExplorer software with the 1203-USB converter.

Important: Please note that there are no plans to provide future updates to this tool and it is being provided 'as-is' for users that lost their DriveExplorer CD, or need to configure legacy products not supported by Connected Components Workbench software.



ATTENTION: DriveExplorer software does not support and must not be used with PowerFlex 520-Series drives. Although a DSI-based drive like the PowerFlex 4-Class drives, it has several new features not supported by DriveExplorer software. **Saving a configuration using DriveExplorer software will be incomplete and data will be lost.** Use Connected Components Workbench software with PowerFlex 520-Series drives.

Topic	Page
Installing DriveExplorer Software	C-1
Configuring the Converter	C-2
Resetting the Converter	C-4
Preparing for a Firmware Update	C-4
Updating the Firmware	C-5
Troubleshooting	C-5
Using RTU Master Mode for a Serial Multi-drop Network	C-8

Installing DriveExplorer Software

The full version of DriveExplorer software is available from the Rockwell Automation website at <http://www.ab.com/support/abdrives/webupdate/software.html>. After downloading the DriveExplorer software to your desktop, double-click its executable file to display the DriveExplorer Setup screen and follow the screen prompts to install the software.

Configuring the Converter

With DriveExplorer software, version 4.04 or later, you can edit parameters in both the 1203-USB converter and the connected drive. With DPI and DSI drives, you can also edit parameters in any of their attached peripherals.

Important: For DriveExplorer software to operate with DSI drives point-to-point, converter **Parameter 01 - [Adapter Cfg]** must be set to '0' (Auto, the default). If this parameter needs to be changed, HyperTerminal software can be used to configure the converter (see [Use with HyperTerminal Software on page E-1](#)).

This procedure is provided to help you use DriveExplorer software with the 1203-USB converter. If you are unsure how to complete a step, refer to the software online help (from the Help menu, choose Help Topics).

1. Obtain and note the COM port that was assigned during installation of the 1203-USB driver by doing the following.

When Using Windows XP Operating System

- a. Open the Windows Control Panel and double-click System.
- b. In the System Properties window, click the Hardware tab.
- c. Click Device Manager.

When Using Windows 7 Operating System

- a. Open the Windows Control Panel.
- b. Click Device Manager.

2. In the Device Manager treeview, expand the Ports (COM & LPT) group.

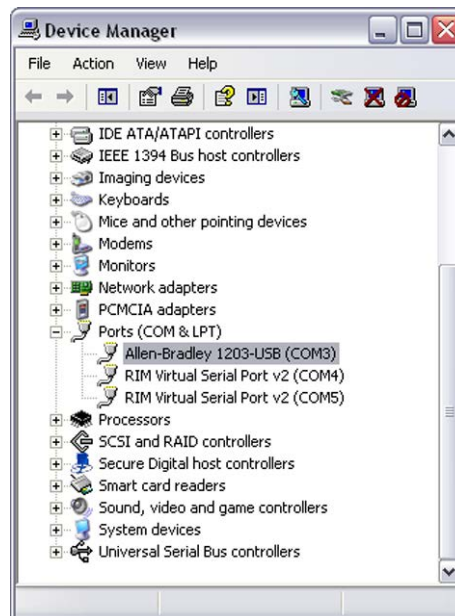

The assigned COM port is shown in parenthesis at the end of the Allen-Bradley 1203-USB entry.

Important: DriveExplorer software has its own drivers. If a driver has been configured using RSLinx software for that same COM port, it must be deleted with RSLinx software before DriveExplorer is launched.

3. If not already running, launch DriveExplorer Lite software (or the full version of DriveExplorer software).
4. From the Explore menu, choose Configure Communication.
5. Select the COM port noted in step 1 and a baud rate of '115200'.
6. Select either checksum, and accept the default time for the Comm Timeout.
7. Click OK.
8. Choose Explore > Connect > Serial Point-to-Point.

A node eventually appears in the DriveExplorer window under Devices in the treeview.

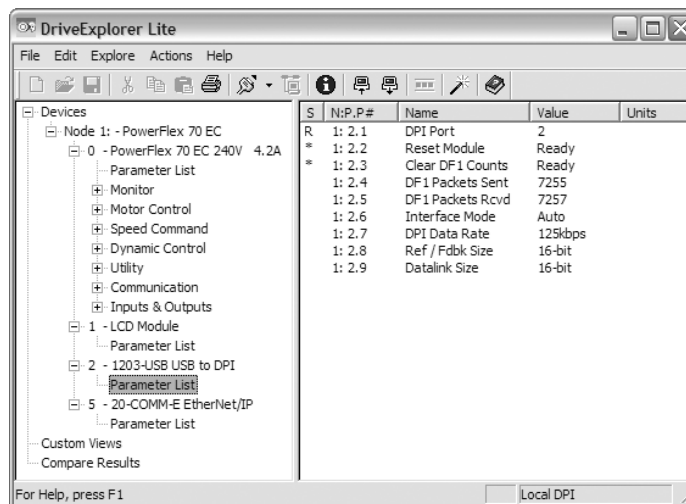

9. In the left pane, click the Parameter List for the 1203-USB converter or connected drive to display its parameters in the right pane.
10. Double-click a parameter to edit it.

Resetting the Converter

Changes to settings of some 1203-USB converter parameters require that you reset the converter before the new settings take effect. You can reset the converter by cycling power to the drive or by using converter **Parameter 02 - [Reset Module]**.



ATTENTION: Risk of injury or equipment damage exists. If the converter is transmitting control I/O to the drive (indicated by a solid green diamond LED), the drive may fault when you remove or reset the converter. Determine how your drive will respond before removing or resetting a connected converter.

Set converter **Parameter 02 - [Reset Module]** to '1' (Reset Module).

When you enter '1' (Reset Module), the converter will be immediately reset. When you enter '2' (Set Defaults), the converter will set all converter parameters to their factory-default values. After performing a Set Defaults, you must enter '1' (Reset Module) or power cycle the drive so that the new values take effect. Thereafter, this parameter will be restored to a value of '0' (Ready).

Preparing for a Firmware Update

Please take the following precautions to ensure a successful firmware update:

- Obtain the new firmware version from Rockwell Automation. Save it to the hard drive of the computer. Do not attempt to perform an update from a removable storage device or a network.
- Read all instructions supplied with the new firmware file.
- Record parameter values in the device that will be updated. Updates may cause parameters to revert to their default settings.
- Verify that the host drive (for example, a PowerFlex 70 EC drive) is stopped.
- Close all programs except DriveExplorer software being used to update the device.
- Disable the screen saver and anti-virus programs so that they do not start during the update.
- Depending on the type of drive, verify the applicable converter parameter setting shown below.

Type of Drive	Converter Parameter	Required Setting
DPI Drives	Parameter 06 - [Interface Mode]	'0' (Auto)
DSI Drives	Parameter 01 - [Adapter Cfg]	'0' (Auto)
SCANport Drives	Parameter 06 - [Interface Mode]	'0' (Auto)

Updating the Firmware

DriveExplorer software, version 4.04 or later, can be used to perform firmware updates on the 1203-USB converter and products that implement DPI or DSI, such as PowerFlex 7-Class drives and peripherals, or PowerFlex 4-Class peripherals—but not PowerFlex 4-Class drives.

Important: PowerFlex 400 drives can only be updated using a AK-U9-FLSH1 flash kit. PowerFlex 4, 40, and 40P drives cannot be updated. Only PowerFlex 4M drives can be updated using the 1203-USB converter.

Important: DriveExplorer software cannot be used to update products that support SCANport.

For information to update firmware, see the respective Release Note for the firmware revision you are updating to on the Allen-Bradley website at <http://www.ab.com/support/abdrives/webupdate>.

Troubleshooting

Viewing Diagnostic Data

Diagnostic items for DPI, DSI, and SCANport drives are listed starting on [page 4-3](#).

1. Connect online with a drive.
2. Select the 1203-USB converter under Devices in the treeview.



3. Click the Device Properties icon  .
4. Click the Diagnostics tab.

The screenshot shows the '1203-USB USB to DSI- Local Adapter' window with the 'Diagnostics' tab selected. The table below lists the diagnostic items:

Item	Name	Value	Units	Save As Text...
1	Field Flash Cnt	3		
2	Adapter Events	1		
3	Reference	0.0	Hz	
4	Logic Cmd	0000 0000 0000 0000		
5	Logic Sts	0000 0110 0000 1101		
6	Feedback	0.0	Hz	
7	Clear DSI Counts	Ready		
8	DSI Packets Sent	21455		
R 9	DSI Packets Rcvd	21453		
R 10	DSI Bad Packet	0		
R 11	DSI Retries	0		

5. Click Close when finished.

Viewing and Clearing Events

The 1203-USB converter maintains an event queue that reports the history of its actions. The event queue can only be accessed when online with the converter. Converter events for DPI, DSI, and SCANport drives are listed starting on [page 4-6](#).

1. Connect online with a drive.
2. Select the 1203-USB converter under Devices in the treeview.



3. Click the Device Properties icon  .
4. Click the Adapter Events tab.

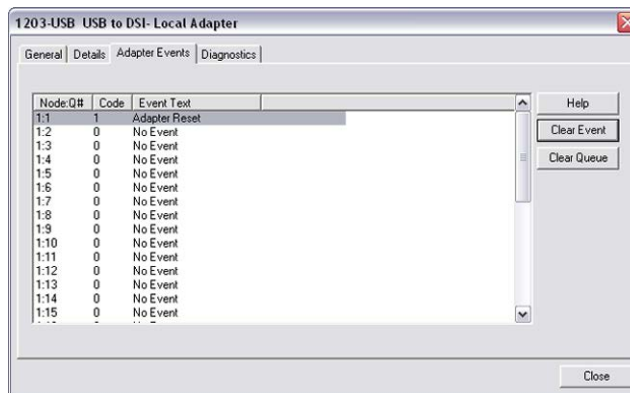

5. Click Clear Event if you want to clear the most recent event, or click Clear Queue if you want to clear the entire queue.

For a list of possible events, see [Converter Events on page 4-6](#).

6. Click Close when finished.

Viewing and Clearing DF1 Communication Statistics

If you encounter unexpected communication problems or are creating an application that uses DF1 data, you can view the communication statistics stored in the converter.

1. Connect online with a drive.
2. Select the 1203-USB Device Parameters under Devices in the treeview.

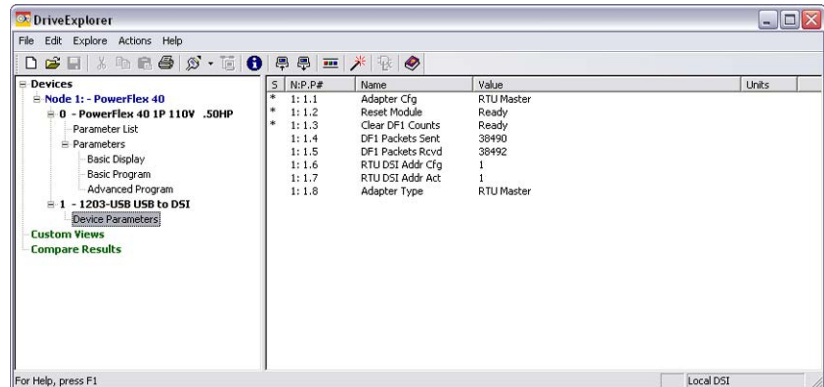

3. View converter **Parameters 04 - [DF1 Packets Sent]** and **05 - [DF1 Packets Rcvd]**.

Both parameters should be incrementing and at approximately the same values.

4. To clear the DF1 counters, set converter **Parameter 03 - [Clear DF1 Counts]** to '1' (Clear Counts).
5. Press Enter.

Using RTU Master Mode for a Serial Multi-drop Network

With the converter in RTU Master mode, you can monitor, configure, and control up to 32 DSI drives.



TIP: A total of 247 drives can be supported on the RTU Master network when RS-485 repeaters are installed.

Important: All PowerFlex 40 and PowerFlex 400 drives on an RTU Master network must have an open internal Port 1. Thus, a 22-COMM-* adapter cannot be connected to this port via the Internal Interface ribbon cable.

Important: All PowerFlex 520-Series drives on an RTU Master network must not have a DSI communication option installed or connected (only the 1203-USB converter can be connected).

When a drive faults in an RTU Master network, all other drives remain operational and unaffected.

Network Wiring

See [Network Wiring on page 3-8](#) for information on wiring an RTU Master serial multi-drop network.

Establishing Communication

Establish communication between the drive connected to the 1203-USB converter and the computer.

Important: When using DriveExplorer software to connect to drives on an RTU Master network, use only DriveExplorer Full software because DriveExplorer Lite software does not support multi-drive connectivity.

Configuring the Drive Parameters

See [Configuring the Drive Parameters on page 3-10](#) for information to configure the drive parameters.

Configuring the Converter for RTU Master Mode

1. On the DriveExplorer 1203-USB Parameter List dialog box, double-click converter **Parameter 01 - [Adapter Cfg]**.

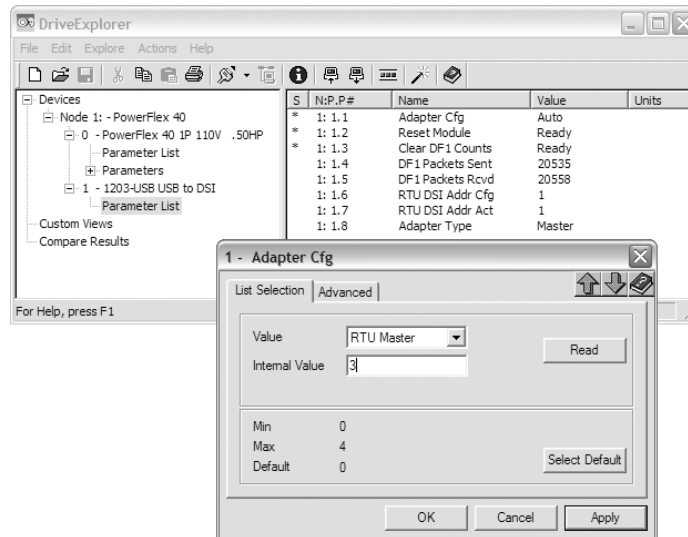

2. Set converter **Parameter 01 - [Adapter Cfg]** to a value of '3' (RTU Master).
3. Remove power from the drive to which the 1203-USB converter is connected, which temporarily ends communication.
4. Electrically connect all drives to create the RTU Master network.
See [Network Wiring on page 3-8](#) for details.

Accessing Drives on the RTU Master (Serial Multi-drop) Network

Using DriveExplorer software enables you to monitor, configure, and control any of the drives on the RTU Master (serial multi-drop) network. You can also monitor and configure the 1203-USB converter.

1. Apply power to all of the drives on the RTU Master network.
2. In the DriveExplorer application window, choose **Explore > Connect > Serial to Network**.

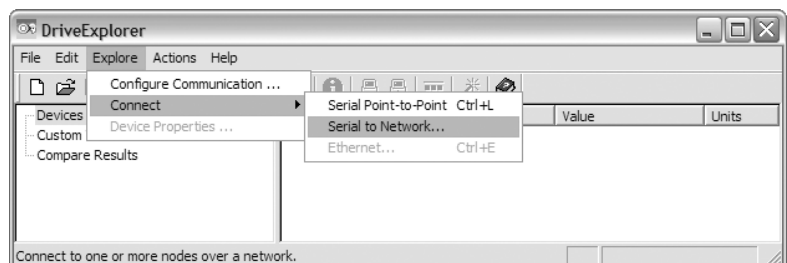

The Network Connection - Node Selection dialog box appears.

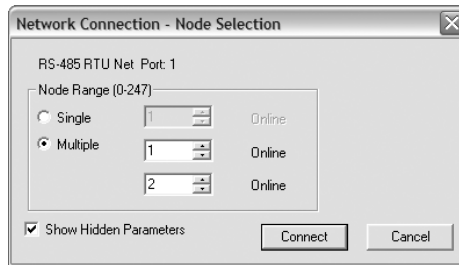

3. In the Network Connection - Node Selection dialog box, click Multiple.
4. From the pull-down menu, choose the node address for the first network drive (for this example, '1').
5. From the pull-down menu, choose the node address for the last network drive (for this example, '2') to view all drives simultaneously in the DriveExplorer online window.
6. Click Connect.

The DriveExplorer network treeview appears.

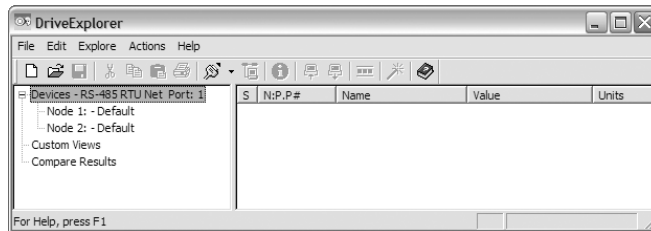

▶ **TIP:** If the network drive node address is valid, 'Online' is shown next to the selected address. 'Offline' appears if a node address is not valid.

7. Click on each node in the treeview to create its database and identity.
8. Expand each node to display the connected drive and 1203-USB converter representation.

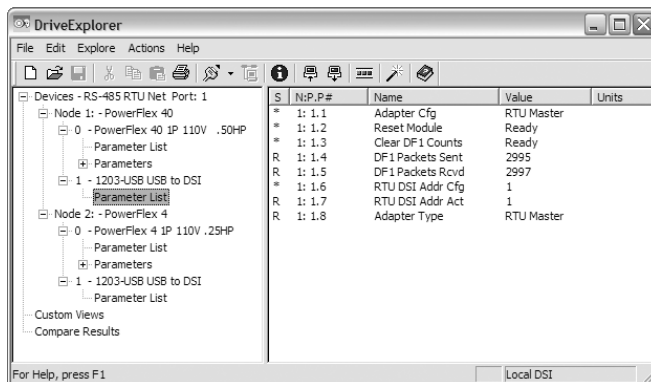

▶ **TIP:** Representation for the 1203-USB converter appears with each drive in the treeview—even though there is only one 1203-USB converter on the network. To access parameters for the 1203-USB converter, click any Parameter List shown for the 1203-USB in the treeview.

Use with DriveExecutive Software

This appendix presents information about using DriveExecutive software with the 1203-USB converter.



ATTENTION: DriveExecutive software does not support and must not be used with PowerFlex 520-Series drives. Although a DSI-based drive like the PowerFlex 4-Class drives, it has several new features not supported by DriveExecutive software. **Saving a configuration using DriveExecutive software will be incomplete and data will be lost.** Use Connected Components Workbench software with PowerFlex 520-Series drives.

Topic	Page
Installing DriveExecutive Software	D-1
Configuring the Converter	D-2
Resetting the Converter	D-6
Preparing for a Firmware Update	D-6
Updating the Firmware	D-7
Troubleshooting	D-7
Using RTU Master Mode for a Serial Multi-drop Network	D-10

Installing DriveExecutive Software

If you do not have DriveExecutive software on your computer and intend to use it as your configuration tool, you must first procure a copy. See [DriveExecutive software, version 1.01 or later on page 1-5](#) for information on how to obtain a copy. After downloading the DriveExecutive software to your desktop, double-click its executable file to display the DriveExecutive Setup screen and follow the screen prompts to install the software.



TIP: The latest DriveExecutive software patches can be downloaded from <http://www.ab.com/support/abdrives/webupdate/software.html>.

Configuring the Converter

With DriveExecutive software, version 1.01 or later, you can edit parameters in both the 1203-USB converter and the connected drive. With DPI and DSI drives, you can also edit parameters in any of their connected peripherals.

Important: For DriveExecutive software to operate with DSI drives point-to-point, converter **Parameter 01 - [Adapter Cfg]** must be set to '0' (Auto, the default). If this parameter needs to be changed, HyperTerminal software can be used to configure the converter (see [Use with HyperTerminal Software on page E-1](#)).

This procedure is provided to help you use DriveExecutive software with the 1203-USB converter. If you are unsure how to complete a step, refer to the software online help (from the Help menu, choose Help Topics).

1. Obtain and note the COM port that was assigned during installation of the 1203-USB driver by doing the following.

When Using Windows XP Operating System

- a. Open the Windows Control Panel and double-click System.
- b. In the System Properties window, click the Hardware tab.
- c. Click Device Manager.

When Using Windows 7 Operating System

- a. Open the Windows Control Panel.
- b. Click Device Manager.

2. In the Device Manager treeview, expand the Ports (COM & LPT) group.

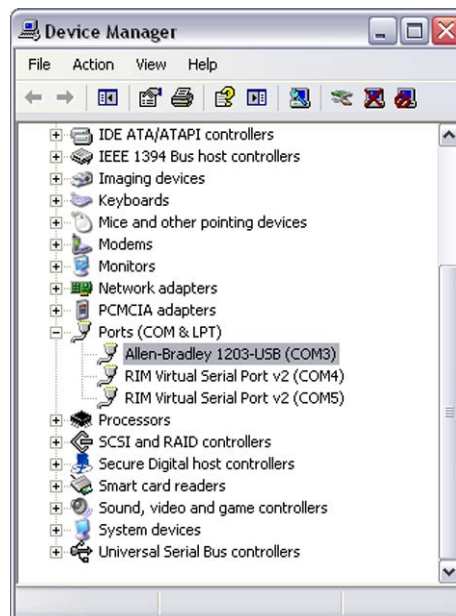

The assigned COM port is shown in parenthesis at the end of the Allen-Bradley 1203-USB entry.

3. Launch RSLinx software to create a driver to represent the connection on the communication port noted in step 1.
4. From the Communications menu, choose Configure Drivers to display the Configure Drivers dialog box.
5. From the Available Driver Types pull-down menu, choose RS-232 DF1 devices.

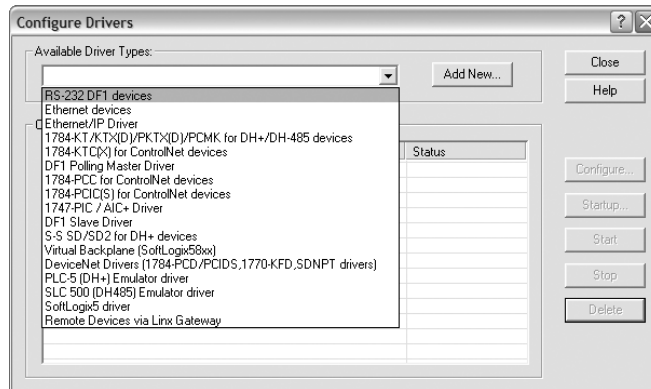

6. After the driver is selected, click Add New.

The Add New RSLinx Driver dialog box appears.

7. Create a name for the new driver (for example, 1203-USB) or use the default name.
8. Click OK.

The Configure RS-232 DF1 Devices dialog box appears.



Important: Do **not** click Auto-Configure because it will not work with the 1203-USB converter. Sometimes clicking Auto-Configure will break the driver. If Auto-Configure was unintentionally clicked, it is best to delete the driver and start over with step 5 above.

9. Enter the following settings.

Configuration Field	Setting
Comm Port	Select the same COM port established during installation of the 1203-USB driver (noted in step 1 on page D-2). For this example, COM5 is used.
Device	1770-KF2/1785-KE/SCANport
Baud Rate	115200
Station Number	00 (default)
Parity	None (default)
Error Checking	BCC (default)
Stop Bits	1 (default)
Protocol	Full Duplex (default)

10. Click OK.

The Configure Drivers dialog box appears.

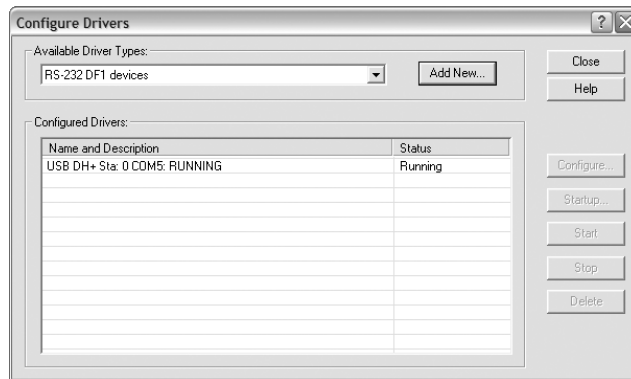

11. Verify that the status of the newly created driver is 'Running'.

12. Click Close.

13. From the Communications menu, choose RSWho to display the browse window.

14. Expand the treeview in the left pane to display the 'DPI' or 'DSI' icon to verify that the driver is communicating with the device.

The browse window should look similar to this example window.

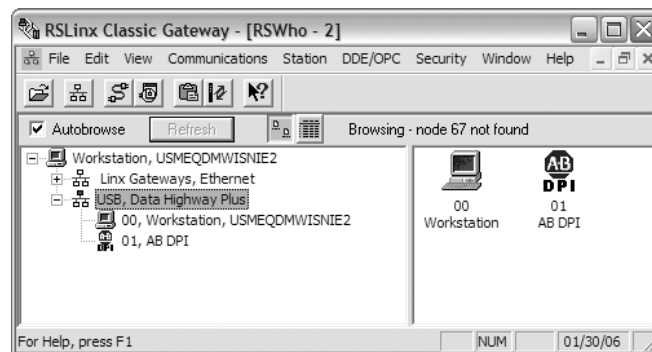

15. Launch DriveExecutive software to access parameters in the 1203-USB converter, the connected drive, and any connected peripherals.
16. From the Drive menu, choose Connect to Drive to display the Connect To Drive treeview window.
17. Expand the treeview in the left pane to display the 'DPI' icon.

The window should look similar to this example window.

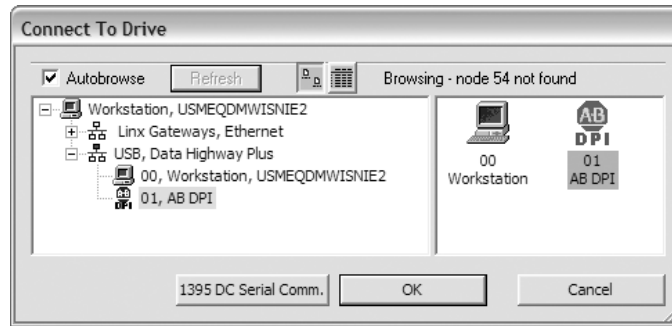

18. Select the DPI icon in the right pane.
19. Click OK.

DriveExecutive will begin updating drive information such as parameter names, diagnostics, and so forth, and store them in a DriveExecutive software directory established for this purpose.

20. In the left pane of the DriveExecutive window, click '+' to expand the treeview.

For this example, click 1203-USB. Then click Linear List to display its parameters in the right pane.

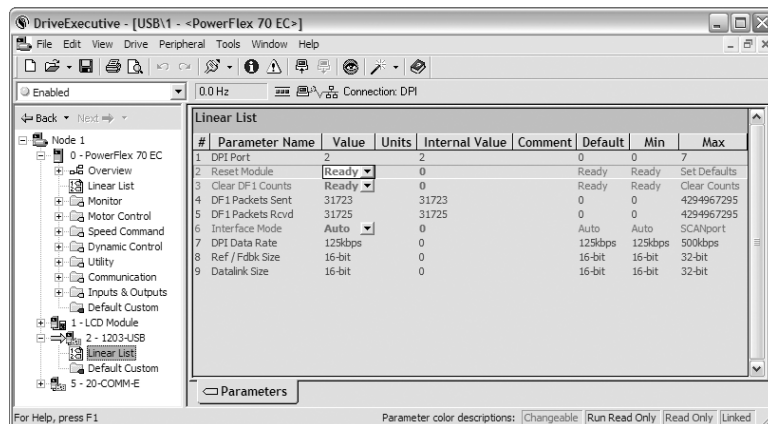

21. To edit a parameter, double-click it or use the Value column pull-down menu.

Resetting the Converter

Changes to settings of some 1203-USB converter parameters require that you reset the converter before the new settings take effect. You can reset the converter by cycling power to the drive or by using converter **Parameter 02 - [Reset Module]**.



ATTENTION: Risk of injury or equipment damage exists. If the converter is transmitting control I/O to the drive (indicated by a solid green diamond LED), the drive may fault when you remove or reset the converter. Determine how your drive will respond before removing or resetting a connected converter.

Set converter **Parameter 02 - [Reset Module]** to '1' (Reset Module).

When you enter '1' (Reset Module), the converter will be immediately reset. When you enter '2' (Set Defaults), the converter will set all converter parameters to their factory-default values. After performing a Set Defaults, you must enter '1' (Reset Module) or power cycle the drive so that the new values take effect. Thereafter, this parameter will be restored to a value of '0' (Ready).

Preparing for a Firmware Update

Please take the following precautions to ensure a successful firmware update:

- Obtain the new firmware version from Rockwell Automation. Save it to the hard drive of the computer. Do not attempt to perform an update from a removable storage device or a network.
- Read all instructions supplied with the new firmware file.
- Record parameter values in the device that will be updated. Updates may cause parameters to revert to their default settings.
- Verify that the host drive (for example, a PowerFlex 70 EC drive) is stopped.
- Close all programs except DriveExecutive software being used to update the device.
- Disable the screen saver and anti-virus programs so that they do not start during the update.
- Depending on the type of drive, verify the applicable converter parameter setting shown below.

Type of Drive	Converter Parameter	Required Setting
DPI Drives	Parameter 06 - [Interface Mode]	'0' (Auto)
DSI Drives	Parameter 01 - [Adapter Cfg]	'0' (Auto)
SCANport Drives	Parameter 06 - [Interface Mode]	'0' (Auto)

Updating the Firmware

DriveExecutive software, version 1.xx or later, can be used to perform firmware updates on the 1203-USB converter and products that implement DPI or DSI, such as PowerFlex 7-Class drives and peripherals, or PowerFlex 4-Class peripherals—but not PowerFlex 4-Class drives.

Important: PowerFlex 400 drives can only be updated using a AK-U9-FLSH1 flash kit. PowerFlex 4, 40, and 40P drives cannot be updated. Only PowerFlex 4M drives can be updated using the 1203-USB converter.

Important: DriveExecutive software cannot be used to update products that support SCANport.

For information to update firmware, see the respective Release Note for the firmware revision you are updating to on the Allen-Bradley website at <http://www.ab.com/support/abdrives/webupdate>.

Troubleshooting

Viewing Diagnostic Data

Diagnostic items for DPI, DSI, and SCANport drives are listed starting on [page 4-3](#).

1. Connect online with a drive.
2. Select the 1203-USB converter in the treeview.

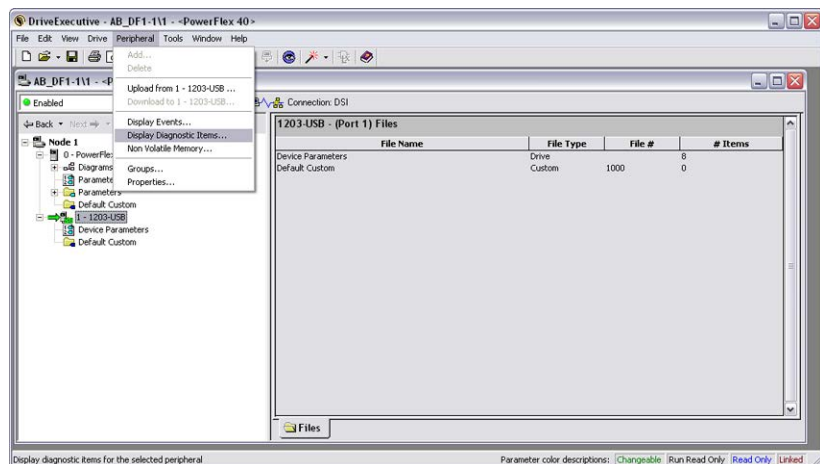

- From the Peripheral menu, choose Display Diagnostic Items to open the Diagnostics dialog box.

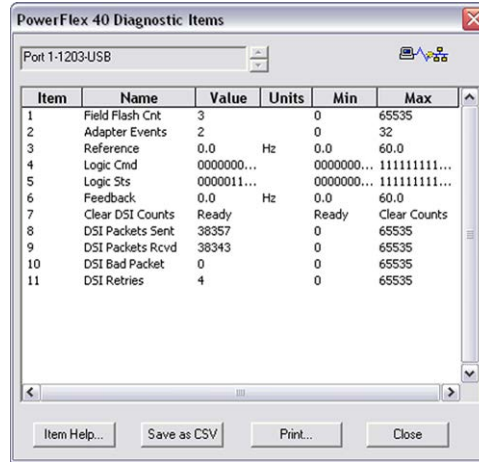

- Click Close when finished.

Viewing and Clearing Events

The 1203-USB converter maintains an event queue that reports the history of its actions. The event queue can only be accessed when online with the converter. Converter events for DPI, DSI, and SCANport drives are listed starting on [page 4-6](#).

- Connect online with a drive.
- Select the 1203-USB converter in the treeview.

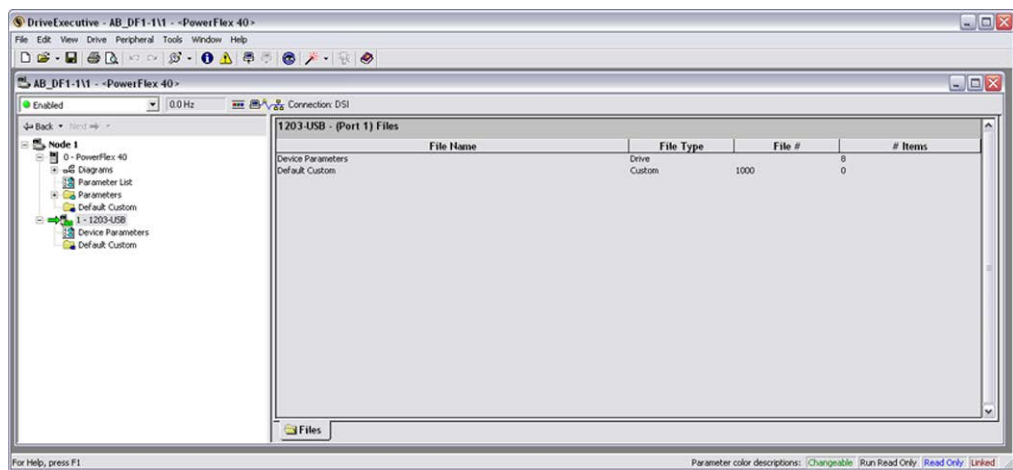

- Click the Fault, Event & Alarm icon  to open the Fault, Event, and Alarm Information dialog box.

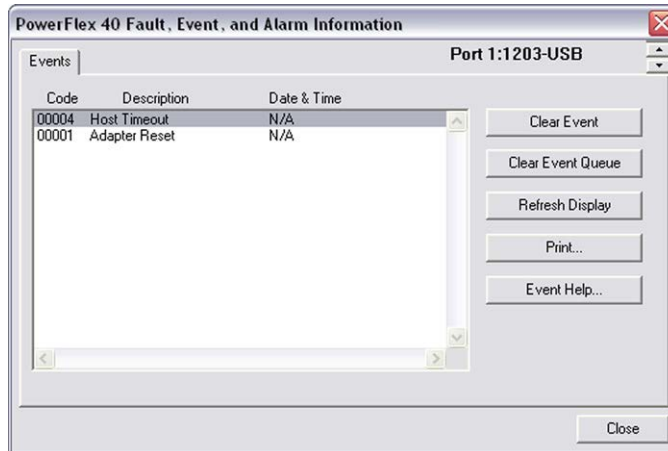

- Click Clear Event if you want to clear the most recent event, or click Clear Event Queue if you want to clear the entire queue.

For a list of possible events, see [Converter Events on page 4-6](#).

- Click Close when finished.

Viewing and Clearing DF1 Communication Statistics

If you encounter unexpected communications problems or are creating an application that uses DF1 data, you can view the communications statistics stored in the converter.

- Connect online with a drive.
- Select Device Parameters under the 1203-USB converter in the treeview.

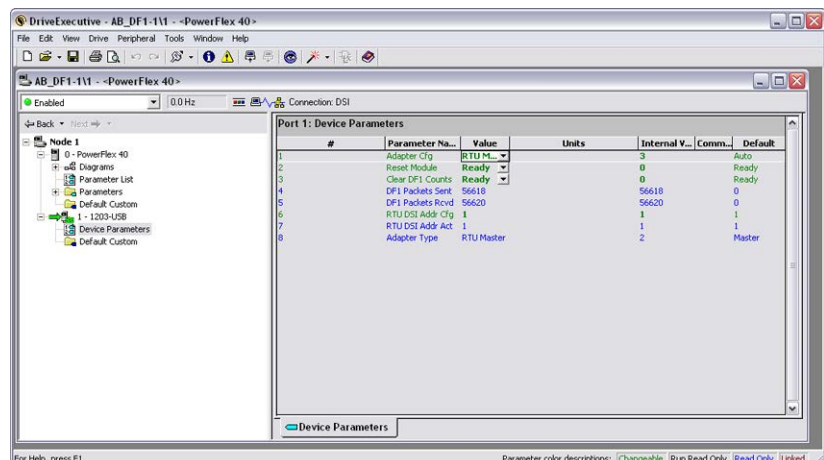

- View converter **Parameters 04 - [DF1 Packets Sent]** and **05 - [DF1 Packets Rcvd]**.

Both parameters should be incrementing and at approximately the same values.

4. To clear the DF1 counters, set converter **Parameter 03 - [Clear DF1 Counts]** to '1' (Clear Counts).
5. Press Enter.

Using RTU Master Mode for a Serial Multi-drop Network

With the converter in RTU Master mode, you can monitor, configure, and control up to 32 DSI drives.



TIP: A total of 247 drives can be supported on the RTU Master network when RS-485 repeaters are installed.

Important: All PowerFlex 40 and PowerFlex 400 drives on an RTU Master network must have an open internal Port 1. Thus, a 22-COMM-* adapter cannot be connected to this port via the Internal Interface ribbon cable.

Important: All PowerFlex 520-Series drives on an RTU Master network must not have a DSI communication option installed or connected (only the 1203-USB converter can be connected).

When a drive faults in an RTU Master network, all other drives remain operational and unaffected.

Network Wiring

See [Network Wiring on page 3-8](#) for information on wiring an RTU Master serial multi-drop network.

Establishing Communication

Establish communications between the drive connected to the 1203-USB converter and the computer.

Configuring the Drive Parameters

See [Configuring the Drive Parameters on page 3-10](#) for information to configure the drive parameters.

Configuring the Converter for RTU Master Mode

1. From the pull-down menu in the Value column of the 1203-USB Linear List dialog box for converter **Parameter 01 - [Adapter Cfg]**, choose '3' (RTU Master).

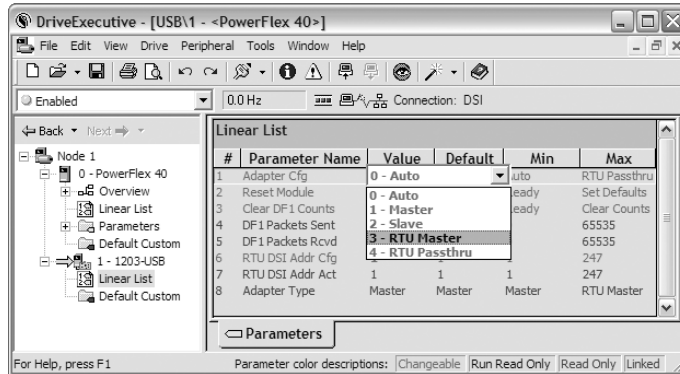

2. Remove power from the drive to which the 1203-USB converter is connected, which temporarily ends communications.
3. Electrically connect all drives to create the RTU Master network.

See [Network Wiring on page 3-8](#) for details.

Configuring RSLinx for Serial Multi-Drop

The Configured Driver in RSLinx is slightly different when configuring for a RS-485 multi-drop system as opposed to a point-to-point system (single drive).

1. Open RSLinx software.
2. From the Communications menu, choose Configure Drivers.



- From the Available Driver Types pull-down menu, choose RS-232 DF1 devices.

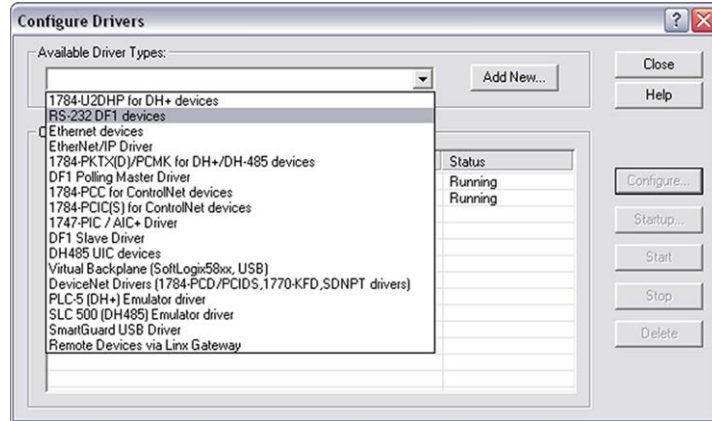

- Click Add New.
- Enter all settings as shown in the following image.

The Comm Port address will vary depending on the port that gets assigned to the 1203-USB converter. In this example, the 1203-USB converter is connected to COM3.



- Click OK.
- Click the RSWho icon  to open the RSWho window.
- Right-click the serial drive that you just added and select Properties.

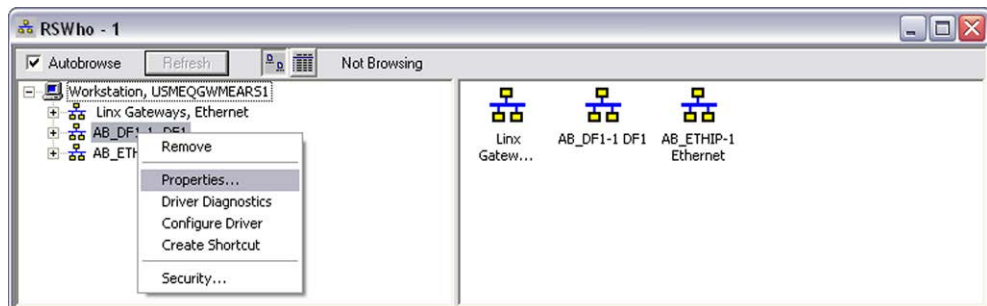

9. On the Browse Addresses tab, check 'Browse only the specified addresses'.



10. Enter the lowest and highest RTU node addresses in your system.

In the previous example image, there are five drives in the system with node addresses 1 through 5.

11. On the Advance Browse Settings tab, check 'Force network type to'.

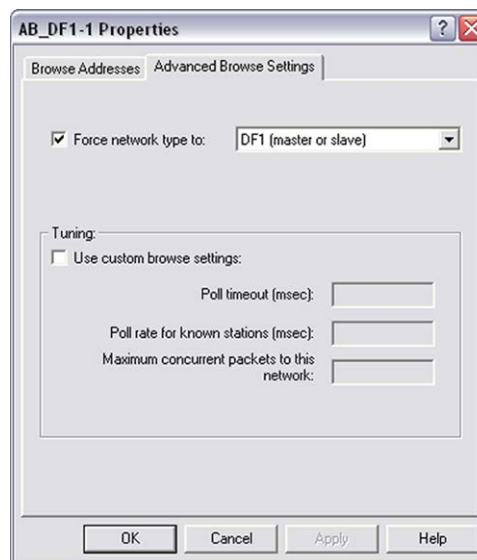

12. From the pull-down menu, choose DF1 (master or slave).

13. Click OK.

14. Close RSLinx software.

Accessing Drives on the RTU Master (Serial Multi-drop) Network

Using DriveExecutive software enables you to monitor, configure, and control any of the drives on the RTU Master (serial multi-drop) network. You can also monitor and configure the 1203-USB converter.

1. Apply power to all of the drives on the RTU Master network.
2. From the Drive menu in the DriveExecutive window, choose Connect to Drive to display the Connect to Drive window.
3. Expand the treeview in the left pane to display either the 'Unrecognized Device' icons (which represent the drives) or the 'DSI' icons.

The window should look similar to the example shown below.

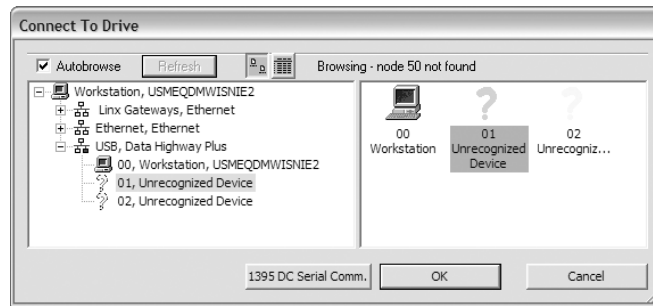

4. Select the drive to which you want to connect to (for this example, the node address 01 drive).
5. Click OK.

DriveExecutive software uploads the drive information and displays its online dialog box. An example is shown below.

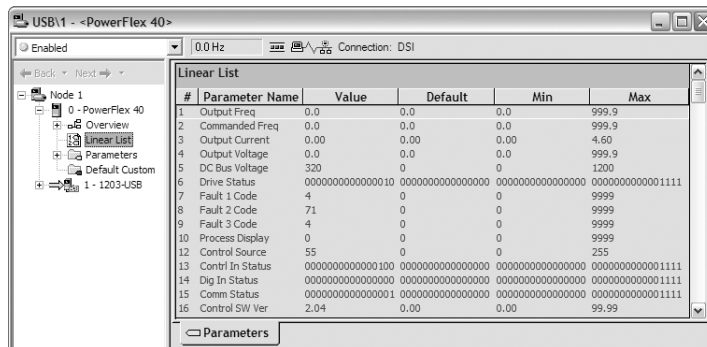

TIP: If the drive information does not exist on the computer or is different than existing information on the computer, DriveExecutive software will automatically create a database file for the drive before displaying its online dialog box.

6. Repeat steps 2 through 5 for each remaining drive on the network.

Example online linear list windows are shown below for each of the drives in this example RTU Master network.

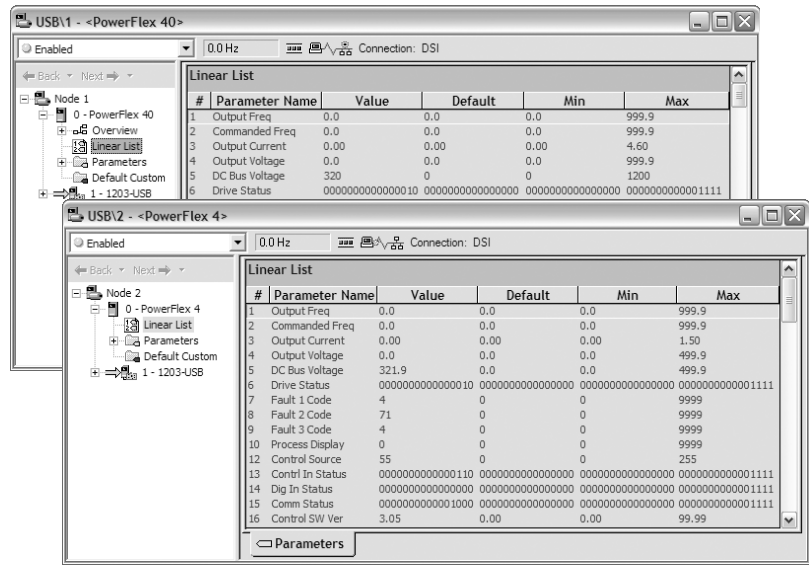

Notes:

Use with HyperTerminal Software

This appendix presents information about using HyperTerminal software with the 1203-USB converter.

Topic	Page
Configuring the Converter	E-1
Resetting the Converter	E-4
Preparing for a Firmware Update	E-5
Updating Firmware	E-5
Troubleshooting	E-6

Configuring the Converter

This section provides detailed instructions on how to use terminal emulation software to access the 1203-USB converter so that you can view and edit its parameters or view its event queue.

A variety of terminal emulation programs can be used to establish a USB connection between a computer and the converter. The following instructions describe how to establish the initial USB connection to the converter using a computer running HyperTerminal—terminal emulation software provided with most Windows operating systems.



TIP: The Windows 7 operating system does not come with HyperTerminal software. An alternative telnet software will have to be used.

Important: The following instructions use example images from Windows XP HyperTerminal software. If you are using a different operating system, the images may differ.

1. Obtain and note the COM port that was assigned during installation of the 1203-USB driver by doing the following.
 - a. Open the Windows Control Panel and double-click System.
 - b. In the System Properties window, click the Hardware tab.
 - c. Click Device Manager.

- d. In the Device Manager treeview, expand the Ports (COM & LPT) group.

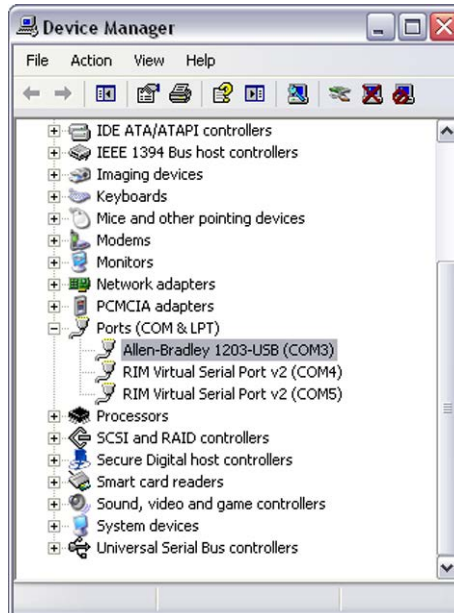

The assigned COM port is shown in parenthesis at the end of the Allen-Bradley 1203-USB entry.

- 2. On the Windows XP desktop, click Start.
- 3. Choose Programs > Accessories > Communications > HyperTerminal.

The Connection Description dialog box appears.



- a. Type a desired name (for example, 1203-USB) in the Name field.
 - b. Select a desired icon from within the Icon field.
- 4. Click OK.

The Connect To dialog box appears.



5. From the 'Connect using' pull-down menu, choose the communications port noted in step 1 on [page E-1](#).
6. Click OK to display the COM Properties dialog box.



7. Select the settings shown in the image above.
8. Click OK.

A blank HyperTerminal workspace appears.



TIP: From the File menu, choose Save to save the HyperTerminal configuration that you just created. In future connections, you can select the saved configuration and quickly connect to the 1203-USB converter.









9. Press Enter until the main menu appears.

```
Main Menu - Enter Number for Selection
1 > Display Setup Parameters
2 > Display Event Queue
3 > Flash Upgrade
```



TIP: If no text or meaningless text appears instead of the Main Menu, it is possible that a baud rate other than '115200' was selected. See step 6 above.

Navigating with Terminal Emulation Software

Key	Function
 ... 	In the main menu, keys 1...3 select a menu option. In the parameter screen, keys 0...9 enter a value.
	Display the main menu or abort changes to a parameter.
 or 	Scroll through parameters or events.
 or 	Scroll through the values for a parameter.
	Save a value for a parameter.

Resetting the Converter

Changes to settings of some 1203-USB converter parameters require that you reset the converter before the new settings take effect. You can reset the converter by cycling power to the drive or by using converter **Parameter 02 - [Reset Module]**.



ATTENTION: Risk of injury or equipment damage exists. If the converter is transmitting control I/O to the drive (indicated by a solid green diamond LED), the drive may fault when you remove or reset the converter. Determine how your drive will respond before removing or resetting a connected converter.

Set converter **Parameter 02 - [Reset Module]** to '1' (Reset Module).

The following HyperTerminal workspace is used to reset the converter.

```
Press the UP ARROW or DOWN ARROW key to scroll
through the parameter list. Press the LEFT ARROW
or RIGHT ARROW key to modify parameter values.
Press the ENTER key to save a new value.
```

```
2> Reset Module = Reset Module
```

When you enter '1' (Reset Module), the converter will be immediately reset. When you enter '2' (Set Defaults), the converter will set all converter parameters to their factory-default values. After performing a Set Defaults, you must enter '1' (Reset Module) or power cycle the drive so that the new values take effect. Thereafter, this parameter will be restored to a value of '0' (Ready).

Preparing for a Firmware Update

Please take the following precautions to ensure a successful firmware update:

- Obtain the new firmware version from Rockwell Automation. Save it to the hard drive of the computer. Do not attempt to perform an update from a removable storage device or a network.
- Read all instructions supplied with the new firmware file.
- Use a computer running terminal emulation software that supports Xmodem transfers. For example, in this appendix we show how to use HyperTerminal software.
- Record parameter values in the device that will be updated. Updates may cause parameters to revert to their default settings.
- Verify that the host drive (for example, a PowerFlex 70 EC drive) is stopped.
- Close all programs except the terminal emulation program being used to update the device.
- Disable the screen saver and anti-virus programs so that they do not start during the update.
- Depending on the type of drive, verify the applicable converter parameter setting shown below.

Type of Drive	Converter Parameter	Required Setting
DPI Drives	Parameter 06 - [Interface Mode]	'0' (Auto)
DSI Drives	Parameter 01 - [Adapter Cfg]	'0' (Auto)
SCANport Drives	Parameter 06 - [Interface Mode]	'0' (Auto)

Updating Firmware

HyperTerminal software can be used to perform firmware updates on the 1203-USB converter and products that implement DPI or DSI, such as PowerFlex 7-Class drives and peripherals, or PowerFlex 4-Class peripherals—but not PowerFlex 4-Class drives.

Important: PowerFlex 400 drives can only be updated using a AK-U9-FLSH1 flash kit. PowerFlex 4, 40, and 40P drives cannot be updated. Only PowerFlex 4M drives can be updated using the 1203-USB converter.

For information to update firmware, see the respective Release Note for the firmware revision you are updating to on the Allen-Bradley website at <http://www.ab.com/support/abdrives/webupdate>.

Troubleshooting

Viewing Diagnostic Data

Diagnostic items are not accessible with HyperTerminal software. Use Connected Components Workbench software or one of the other drive software tools to view diagnostic items.

Viewing and Clearing Events

The 1203-USB converter maintains an event queue that reports the history of its actions. The event queue can only be accessed when online with the converter. Converter events for DPI, DSI, and SCANport drives are listed starting on [page 4-6](#).

Viewing the Event Queue

1. Access the 1203-USB converter event queue.
2. Scroll through events in the event queue.

```
Press the UP ARROW or DOWN ARROW key to scroll
through the parameter list. Press the LEFT ARROW
or RIGHT ARROW key to modify parameter values.
Press the ENTER key to save a new value.
```

```
2R> Event Queue 1 = Normal Startup
```

The most recent event can be found at '2R > Event Queue 1', where the 'R' indicates Read Only. For a list of possible events, see [Converter Events on page 4-6](#).

Clearing the Event Queue

1. Access the 1203-USB converter event queue.

```
Press the UP ARROW or DOWN ARROW key to scroll
through the parameter list. Press the LEFT ARROW
or RIGHT ARROW key to modify parameter values.
Press the ENTER key to save a new value.
```

```
1> Clr Event Queue = Enable
```

2. Set the '1 > Clr Event Queue' parameter to Enable.
3. Press Enter to clear the event queue.

Viewing and Clearing DF1 Communication Statistics

If you encounter unexpected communications problems or are creating an application that uses DF1 data, you can view the communications statistics stored in the converter.

To view and clear DF1 data, you must access the main menu in the 1203-USB converter firmware.

Viewing DF1 Data

1. Access the parameters in the 1203-USB converter using HyperTerminal software.
2. View converter parameters **Parameters 04 - [DF1 Packets Sent]** and **05 - [DF1 Packets Rcvd]**, which store DF1 data.

```
Press the UP ARROW or DOWN ARROW key to scroll
through the parameter list. Press the LEFT ARROW
or RIGHT ARROW key to modify parameter values.
Press the ENTER key to save a new value.
```

```
4R> DF1 Packets Sent = 0
```

See the following pages for a description of each parameter:

- [Parameters – DPI Drives on page B-1](#)
- [Parameters – DSI Drives on page B-2](#)
- [Parameters – SCANport Drives \(DriveExplorer or DriveExecutive software only\) on page B-4](#)

Clearing DF1 Data Counters

1. Access the parameters in the 1203-USB converter using HyperTerminal software.
2. View converter **Parameter 03 - [Clear DF1 Counts]**.

```
Press the UP ARROW or DOWN ARROW key to scroll
through the parameter list. Press the LEFT ARROW
or RIGHT ARROW key to modify parameter values.
Press the ENTER key to save a new value.
```

```
3> Clear DF1 Counts = Clear Counts
```

3. Set its value to Clear Counts.
4. Press Enter to clear the DF1 data.

Notes:

History of Changes

Topic	Page
DRIVES-UM001C-EN-P, September 2012	F-1
DRIVES-UM001B-EN-P, October 2006	F-1

This appendix summarizes the revisions to this manual. Reference this appendix if you need information to determine what changes have been made across multiple revisions. This may be especially useful if you are deciding to upgrade your hardware or software based on information added with previous revisions of this manual.

DRIVES-UM001C-EN-P, September 2012

Change
Reformatted this document from half size (5.5 x 8.5 in.) to full size (8.5 x 11 in.)
Reorganized document so that information about using the Connected Components Workbench software tool is contained and described in the main part of the document. Information to use the DriveExplorer, DriveExecutive, and HyperTerminal software tool is now located in respectively titled appendixes.

DRIVES-UM001B-EN-P, October 2006

Change
In Appendix C in the 'Performing a Flash Update with DriveExplorer' section, added an Attention statement in step 8 to not remove power from the drive during flashing.
In Appendix C in the 'Performing a Flash Update with DriveExecutive' section, added an Attention statement in step 8 to not remove power from the drive during flashing.

Notes:

A Application Code

Code that runs in the converter after the boot code calls it. Application code performs the normal operations of the converter.

B BCC (Block Check Character)

An error detection scheme using the 2's complement of the 8-bit sum (modulo-256 arithmetic sum) of all data bytes in a transmission block. It provides a means of checking the accuracy of each message transmission.

Boot Code

Code that runs when the converter first receives power. Boot code checks basic operations and then calls the application code.

Bus Off

This term is applicable to only products that implement DPI or SCANport. A bus off condition occurs when an abnormal rate of errors is detected on the Control Area Network (CAN) bus in a device. The bus-off device cannot receive or transmit messages. This condition is often caused by corruption of the network data signals due to noise or data rate mismatch.

C Connected Components Workbench Software

The recommended tool for monitoring and configuring Allen-Bradley products and network communication adapters. It can be used on computers running various Microsoft Windows operating systems. You can obtain a **free copy** of Connected Components Workbench software at <http://www.ab.com/support/abdrives/webupdate/software.html>.

ControlFLASH

A **free** software tool used to electronically update the firmware of Allen-Bradley products and network communication adapters. ControlFLASH software is downloaded automatically when the firmware revision file for the product being updated is downloaded from the Allen-Bradley updates website to your computer.

Converter

The 1203-USB converter provides an electronic communications interface between any Allen-Bradley product implementing DPI, DSI, or SCANport and a computer with a USB port. This converter uses a full-duplex RS-232 DF1 protocol. The converter may also be referred to as '1203-USB' or 'peripheral'.

CRC (Cyclic Redundancy Check)

An error detection scheme where all of the characters in a message are treated as a string of bits representing a binary number. This number is divided by a predetermined binary number (a polynomial) and the remainder is appended to the message as a CRC character. A similar operation occurs at the receiving end to prove transmission integrity.

D DF1 Protocol

A peer-to-peer link layer protocol that combines features of ANSI X3.28-1976 specification subcategories D1 (data transparency) and F1 (two-way simultaneous transmission with embedded responses).

DF1 Rate

A unit of signaling speed equal to the number of discrete conditions or signal events per second. It is also called 'baud rate' or 'port rate'.

DPI (Drive Peripheral Interface)

A second generation peripheral communication interface used by various Allen-Bradley drives and power products, such as PowerFlex 7-Class drives. It is a functional enhancement to SCANport.

DPI Peripheral

A device that provides an interface between DPI and a network or user. Peripheral devices are also referred to as 'adapters' and 'modules'. The 1203-USB converter, 20-COMM-x network communication adapters, and PowerFlex 7-Class HIMs (20-HIM-xxx) are examples of DPI peripherals.

DPI Product

A device that uses the DPI communications interface to communicate with one or more peripheral devices. For example, a motor drive such as a PowerFlex 7-Class drive is a DPI product. In this manual, a DPI product is also referred to as 'drive' or 'host'.

DriveExplorer Software

A tool for monitoring and configuring Allen-Bradley products and network communication adapters. It can be used on computers running various Microsoft Windows operating systems. DriveExplorer software, version 4.04 or later, can be used to configure the 1203-USB converter and connected drive. This software tool has been discontinued and is now available as **freeware** at <http://www.ab.com/support/abdrives/webupdate/software.html>. There are no plans to provide future updates to this tool and the download is being provided 'as-is' for users that lost their DriveExplorer CD, or need to configure legacy products not supported by Connected Components Workbench software.

DriveTools SP Software

A software suite designed for running on various Microsoft Windows operating systems. This software suite provides a family of tools, including DriveExecutive software (version 3.01 or later), that you can use to program, monitor, control, troubleshoot, and maintain Allen-Bradley products. DriveTools SP software, version 1.01 or later, can be used with PowerFlex 7-Class and PowerFlex 4-Class drives, and legacy drives that implement the SCANport communication interface. Information about DriveTools SP software can be accessed at <http://www.ab.com/drives/drivetools>.

DSI (Drive Serial Interface)

DSI is based on the Modbus RTU serial communication protocol and is used by PowerFlex 4-Class drives, PowerFlex 520-Series drives, and Kinetix 3 drives.

DSI Peripheral

A device that provides an interface between DSI and a network or user. Peripheral devices are also referred to as ‘adapters’ and ‘modules’. The 1203-USB converter, 22-COMM-x network communication adapters, and PowerFlex 4-Class HIMs (22-HIM-xxx) are examples of DSI peripherals.

DSI Product

A device that uses the DSI communications interface to communicate with one or more peripheral devices. For example, a motor drive such as a PowerFlex 4-Class drive is a DSI product. In this manual, a DSI product is also referred to as ‘drive’ or ‘host’.

H HIM (Human Interface Module)

A device that can be used to configure and control a PowerFlex 7-Class drive or a PowerFlex 4-Class drive. PowerFlex-7 Class HIMs (20-HIM-xxx) and PowerFlex 4-Class HIMs (22-HIM-xxx) can be used to configure connected peripherals.

Hold Last

When communications are disrupted (for example, a cable is disconnected), the converter and drive can respond by holding last state. Hold last state results in the drive receiving the last data received via the DF1 connection before the disruption. If the drive was running and using the Reference from the converter, it will continue to run at the same Reference.

N NVS (Non-Volatile Storage)

NVS is the permanent memory of a device. Devices such as the converter and drive store parameters and other information in NVS so that they are not lost when the device loses power. NVS is sometimes called ‘EEPROM’.

P PCCC (Programmable Controller Communications Commands)

PCCC is the protocol used by some controllers to communicate with devices on a network. Some software products (for example, DriveExplorer and DriveExecutive) also use PCCC to communicate.

Ping

A message that is sent by a DPI or SCANport drive to its peripheral devices, which use the ping to gather data about the product, including whether it can receive messages and whether they can log in for control.

PowerFlex 4-Class (Compact-Class) Drives

The Allen-Bradley PowerFlex 4-Class (Compact-Class) family of drives include the PowerFlex 4, PowerFlex 4M, PowerFlex 40, PowerFlex 40P, and PowerFlex 400 drives. All PowerFlex 4-Class drives support DSI.

PowerFlex 7-Class (Architecture-Class) Drives

The Allen-Bradley PowerFlex 7-Class (Architecture-Class) family of drives include the PowerFlex 70/70EC, PowerFlex 700/700VC, PowerFlex 700 Series B, PowerFlex 700H, PowerFlex 700S, PowerFlex 700L, PowerFlex 750-Series, and PowerFlex 7000 drives. All PowerFlex 7-Class drives support DPI.

S SCANport

A peripheral communications interface used by various Allen-Bradley drives and power products, such as 1305 and 1336 PLUS II drives.

SCANport Peripheral

A device that provides an interface between SCANport and a network or user. Peripheral devices are also referred to as ‘adapters’ and ‘modules’. The 1203-USB converter, 1203-xxx network communication modules, and HIMs are examples of SCANport peripherals.

SCANport Product

A device that uses the SCANport communications interface to communicate with one or more peripheral devices. For example, a motor drive such as a 1336 PLUS II is a SCANport product. In this manual, a SCANport product is also referred to as ‘drive’ or ‘host’.

Status Indicators

LEDs that are used to report the status of the converter. There are three status indicators on the converter.

U Update

The process of updating firmware in a device. PowerFlex 7-Class and PowerFlex 4-Class drives and their peripherals can be updated using the Allen-Bradley software tool ControlFLASH, or the built-in update capability of DriveExplorer or DriveExecutive software.

X Xmodem

Developed by Ward Christensen in 1978, Xmodem is a protocol used to transfer data. You can use the Xmodem protocol to update the firmware in the converter or a device connected to it.

Z Zero Data

When communications are disrupted (for example, a cable is disconnected), the converter and connected drive can respond with zero data. Zero data results in the drive receiving zero as values for command data. If the drive was running and using the Reference from the converter, it will stay running but at zero Reference.

Notes:

A

accessing parameters
 using Connected Components Workbench software, **3-2**
 using DriveExecutive software, **D-2**
 using DriveExplorer software, **C-2**
 using terminal emulation software, **E-1**

Adapter Cfg parameter (only DSI drives), **B-2**

Adapter Port parameter (only SCANport drives), **B-4**

Adapter Type parameter (only DSI drives), **B-3**

adapter, see *converter*

agency certification, **A-2**

application code, **G-1**

attentions, **1-6**

B

baud rate, see *DF1 rate*

BCC (Block Check Character), **A-1, G-1**

boot code, **G-1**

bus off, **G-1**

C

cables
 disconnecting, **2-13**
 for connecting the
 DPI or SCANport drive and computer, **1-2, 2-2**
 DSI drive and computer, **1-2, 2-3**

checksum, **A-1**

Clear DF1 Counts parameter
 for DPI drives, **B-1**
 for DSI drives, **B-3**
 for SCANport drives, **B-4**

clearing DF1 data
 using Connected Components Workbench software, **4-9**
 using DriveExecutive software, **D-9**
 using DriveExplorer software, **C-7**
 using HyperTerminal software, **E-7**

clearing events
 using DriveExecutive software, **D-8**
 using DriveExplorer software, **C-6**
 using HyperTerminal software, **E-6**

communications specifications, **A-1**

compatible products, **1-3**

components of converter, **1-2**

configuration tools, **3-1**

Connected Components Workbench software
 definition, **G-1**
 to configure converter, **3-2**
 to configure RTU Master mode, **3-11**
 to update, **3-8**
 website, **G-1**

ControlFLASH, **G-1**

converter
 accessing, **3-1**
 components, **1-2**
 configuring
 using Connected Components Workbench software, **3-2**
 using DriveExecutive software, **D-2**
 using DriveExplorer software, **C-2**
 using HyperTerminal software, **E-1**
 configuring RTU Master mode
 using Connected Components Workbench software, **3-11**
 using DriveExecutive software, **D-11**
 using DriveExplorer software, **C-9**
 connecting cables, **1-2, 2-2, 2-3**
 definition, **G-1**
 dimensions, **A-1**
 event queue
 using Connected Components Workbench software, **4-8**
 using DriveExecutive software, **D-8**
 using DriveExplorer software, **C-6**
 using HyperTerminal software, **E-6**
 features, **1-2**
 illustration, **1-2**
 installing, **2-2, 2-3**
 parameters
 for DPI drives, **B-1 to B-2**
 for DSI drives, **B-2 to B-3**
 for SCANport drives, **B-4**
 power consumption, **A-1**
 removing, **2-13**
 resetting
 using Connected Components Workbench software, **3-7**
 using DriveExecutive software, **D-6**
 using DriveExplorer software, **C-4**
 using HyperTerminal software, **E-4**

CRC (Cyclic Redundancy Check), **A-1, G-1**

D

- data bits, **A-1**
- Datalink Size parameter (only DPI drives), **B-2**
- DF1
 - port rates, **A-1**
 - protocol definition, **G-2**
 - rate definition, **G-2**
 - viewing data
 - using Connected Components Workbench software, **4-9**
 - using DriveExecutive software, **D-9**
 - using DriveExplorer software, **C-7**
 - using HyperTerminal software, **E-7**
- DF1 Packets Rcvd parameter
 - for DPI drives, **B-2**
 - for DSI drives, **B-3**
 - for SCANport drives, **B-4**
- DF1 Packets Sent parameter
 - for DPI drives, **B-1**
 - for DSI drives, **B-3**
 - for SCANport drives, **B-4**
- diagnostic items, **4-3**
- Diamond status indicator, **4-2**
- dimensions of converter, **A-1**
- documentation, related, **P-2**
- DPI
 - cable, **1-2, 2-2**
 - compatible products, **1-3**
 - definition, **G-2**
 - peripheral, **G-2**
 - product, **G-2**
- DPI Data Rate parameter (only DPI drives), **B-2**
- DPI Port parameter (only DPI drives), **B-1**
- DriveExecutive software
 - documentation, **P-2**
 - to configure converter, **D-2**
 - to configure RTU Master mode, **D-11**
 - to update, **D-7**
 - website, **G-2**
- DriveExplorer software
 - definition, **G-2**
 - documentation, **P-2**
 - free lite version, **G-2**
 - to configure converter, **C-2**
 - to configure RTU Master mode, **C-9**
 - to update, **C-5**
 - website, **G-2**
- drives, see *DPI product, DSI product, or SCANport product*

- DriveTools SP software
 - definition, **G-2**
 - documentation, **P-2**
 - website, **G-2**

DSI

- cable, **1-2, 2-3**
- compatible products, **1-4**
- definition, **G-3**
- peripheral, **G-3**
- product, **G-3**

E

- EEPROM, see *NVS (Nonvolatile Storage)*
- equipment
 - required, **1-4**
 - supplied, **1-4**
- error detection, **A-1**
- event queue
 - clearing events
 - using Connected Components Workbench software, **4-8**
 - using DriveExecutive software, **D-8**
 - using DriveExplorer software, **C-6**
 - using HyperTerminal software, **E-6**
 - list of events, **4-6**
 - viewing events
 - using Connected Components Workbench software, **4-8**
 - using DriveExecutive software, **D-8**
 - using DriveExplorer software, **C-6**
 - using HyperTerminal software, **E-6**

F

- fault queue, see *event queue*
- firmware parameters
 - for DPI drives, **B-1 to B-2**
 - for DSI drives, **B-2 to B-3**
 - for SCANport drives, **B-4**
- firmware revision conventions, **P-1**
- firmware update, see *update*

H

- HIM (Human Interface Module)
 - definition, **G-3**
- hold last - definition, **G-3**

HyperTerminal software
 main menu, **E-3**
 navigating in, **E-4**
 setting up, **E-1**
 to update, **E-5**

I

installing
 Connected Components Workbench software, **2-12**
 converter, **2-2, 2-3**
 DriveExecutive software, **D-1**
 DriveExplorer software, **C-1**
 driver for USB converter, **2-4**

Interface Mode parameter
 for DPI drives, **B-2**
 for SCANport drives, **B-4**

K

keys used to navigate in terminal emulation software, **E-4**

Kinetix 3 drive cable connections for converter, **2-3**

L

LEDs, see *status indicators*

M

manual
 conventions, **P-1**
 website, **P-2**

mechanical specifications, **A-1**

N

NVS (Nonvolatile Storage)
 definition, **G-3**
 parameters in, **3-1**

P

parameters
 list for DPI drives, **B-1 to B-2**
 list for DSI drives, **B-2 to B-3**
 list for SCANport drives, **B-4**

parity, **A-1**

PCCC (Programmable Controller Communications Commands), **G-3**

ping, **G-3**

port rate, see *DF1 rate*

power consumption, **A-1**

power cycling, **3-7**

PowerFlex 4-Class drives, **G-4**

PowerFlex 7-Class drives, **G-4**

products, see *DPI product, DSI product, or SCANport product*

protocol, **A-1**

Q

quick start, **1-6**

R

Ref/Fdbk Size parameter (only DPI drives), **B-2**

regulatory compliance, **A-2**

related documentation, **P-2**

removing the converter, **2-13**

Reset Module parameter
 for DPI drives, **B-1**
 for DSI drives, **B-2**
 for SCANport drives, **B-4**

resetting the converter
 using Connected Components Workbench software, **3-7**
 using DriveExecutive software, **D-6**
 using DriveExplorer software, **C-4**
 using HyperTerminal software, **E-4**

RTU DSI Addr Act parameter (only DSI drives), **B-3**

RTU DSI Addr Cfg parameter (only DSI drives), **B-3**

RTU Master mode
 accessing drives on the RTU network
 using Connected Components Workbench software, **3-14**
 using DriveExecutive software, **D-14**
 using DriveExplorer software (full version only), **C-9**
 configuring the converter for
 using Connected Components Workbench

- software, **3-11**
- using DriveExecutive software, **D-11**
- using DriveExplorer software, **C-9**
- configuring the drive parameters
 - using Connected Components Workbench software, **3-10**
 - using DriveExecutive software, **D-10**
 - using DriveExplorer software, **C-8**
- establishing communication
 - using Connected Components Workbench software, **3-10**
 - using DriveExecutive software, **D-10**
 - using DriveExplorer software, **C-8**
- network wiring, **3-8**
- RX status indicator, **4-2**

S

- safety precautions, **1-6**
- SCANport
 - cable, **1-2, 2-2**
 - compatible products, **1-4**
 - definition, **G-4**
 - peripheral, **G-4**
 - product, **G-4**
- specifications, **A-1**
- status indicators
 - definition, **G-4**
 - locating, **4-1**
 - operating status, **4-1**
 - troubleshooting with, **4-2**

T

- technical support, **P-1**
- terminal emulation software
 - navigating in, **E-4**
 - using, **E-1**
- tools, see *equipment*
- TX status indicator, **4-2**

U

- update
 - definition, **G-4**
 - preparing for
 - using DriveExecutive software, **D-6**
 - using DriveExplorer software, **C-4**
 - using HyperTerminal software, **E-5**
 - using Connected Components Workbench software, **3-8**
 - using DriveExecutive software, **D-7**
 - using DriveExplorer software, **C-5**
 - using HyperTerminal software, **E-5**
- USB
 - cable, **1-2, 2-2, 2-3**
 - converter driver installation, **2-4**

V

- viewing DF1 data
 - using Connected Components Workbench software, **4-9**
 - using DriveExecutive software, **D-9**
 - using DriveExplorer software, **C-7**
 - using HyperTerminal software, **E-7**

W

- website
 - Allen-Bradley product firmware updates, **C-5, D-7, E-5**
 - Connected Components Workbench software, **G-1**
 - DriveExecutive software, **G-2**
 - DriveExplorer software, **G-2**
 - DriveTools SP software, **G-2**
 - related documentation, **P-2**

X

- Xmodem
 - definition, **G-4**
 - using to update, **E-5**

Z

- zero data - definition, **G-5**

Rockwell Automation Support

Rockwell Automation provides technical information on the Web to assist you in using its products. At <http://www.rockwellautomation.com/support/>, you can find technical manuals, a knowledge base of FAQs, technical and application notes, sample code and links to software service packs, and a MySupport feature that you can customize to make the best use of these tools.

For an additional level of technical phone support for installation, configuration, and troubleshooting, we offer TechConnect support programs. For more information, contact your local distributor or Rockwell Automation representative, or visit <http://www.rockwellautomation.com/support/>.

For U.S. Allen-Bradley Drives Technical Support — Tel: (1) 262.512.8176, Fax: (1) 262.512.2222, Email: support@drives.ra.rockwell.com, Online: <http://www.ab.com/support/abdrives>

Installation Assistance

If you experience a problem within the first 24 hours of installation, review the information that is contained in this manual. You can contact Customer Support for initial help in getting your product up and running.

United States or Canada	1.440.646.3434
Outside United States or Canada	Use the Worldwide Locator at http://www.rockwellautomation.com/support/americas/phone_en.html , or contact your local Rockwell Automation representative.

New Product Satisfaction Return

Rockwell Automation tests all of its products to ensure that they are fully operational when shipped from the manufacturing facility. However, if your product is not functioning and needs to be returned, follow these procedures.

United States	Contact your distributor. You must provide a Customer Support case number (call the phone number above to obtain one) to your distributor to complete the return process.
Outside United States	Please contact your local Rockwell Automation representative for the return procedure.

Documentation Feedback

Your comments will help us serve your documentation needs better. If you have any suggestions on how to improve this document, complete this form, publication [RA-DU002](#), available at <http://www.rockwellautomation.com/literature/>.

Rockwell Otomasyon Ticaret A.Ş., Kar Plaza İş Merkezi E Blok Kat:6 34752 İçerenköy, İstanbul, Tel: +90 (216) 5698400

www.rockwellautomation.com

Power, Control and Information Solutions Headquarters

Americas: Rockwell Automation, 1201 South Second Street, Milwaukee, WI 53204-2496 USA, Tel: (1) 414.382.2000, Fax: (1) 414.382.4444
Europe/Middle East/Africa: Rockwell Automation, Vorstlaan/Boulevard du Souverain 36, 1170 Brussels, Belgium, Tel: (32) 2 663 0600, Fax: (32) 2 663 0640
Asia Pacific: Rockwell Automation, Level 14, Core F, Cyberport 3, 100 Cyberport Road, Hong Kong, Tel: (852) 2887 4788, Fax: (852) 2508 1846