



Allen-Bradley

DeviceNet Pendant Stations

Bulletin 800E/F

User Manual

**Rockwell
Automation**

Important User Information

The illustrations, charts, sample programs, and layout examples shown in this guide are intended solely for purposes of example. Since there are many variables and requirements associated with any particular installation, Allen-Bradley does not assume responsibility or liability (to include intellectual property liability) for actual use based upon the examples shown in this publication.

Allen-Bradley publication SGI-1.1, *Safety Guidelines for the Application, Installation, and Maintenance of Solid-State Control* (available from your local Allen-Bradley office), describes some important differences between solid-state equipment and electromechanical devices that should be taken into consideration when applying products such as those described in this publication.

Reproduction of the contents of this copyrighted publication, in whole or in part, without written permission of Allen-Bradley Company, Inc., is prohibited.

Throughout this manual we use notes to make you aware of safety considerations:



ATTENTION: Identifies information about practices or circumstances that can lead to personal injury or death, property damage or economic loss.

Attention statements help you to:

- identify a hazard
- avoid the hazard
- recognize the consequences

Important: Identifies information that is critical for successful application and understanding of the product.

Table of Contents

Important User Information	1
----------------------------------	---

Preface

This manual gives an overview of the Bulletin 800E/F DeviceNet™ Pendant Station and describes how to configure, install, operate and troubleshoot the device on the DeviceNet™ Network.....	P-1
Intended Audience	P-1
Contents of Manual	P-2
Related Publications	P-2
EDS Web Site	P-2

Chapter 1 Overview of DeviceNet™ Pendant Station

Chapter Objectives	1-1
Description	1-1
Enclosure Features	1-2
Summary of Features	1-2
DeviceNet™ Connection	1-3
DeviceNet™ Sealed Connector	1-3
Typical DeviceNet™ Configuration	1-4
DeviceNet™ Components	1-5
Replacement Parts	1-5

Chapter 2 Quick Start

Chapter Objectives	2-1
Data Rate Configuration	2-1
Node Address Configuration	2-1
Connection to the Network	2-2
Pendant Station Parameter Configuration	2-2
Scanner Configuration	2-4

Chapter 3 Installation and Mounting

Chapter Objectives 3-1

DeviceNet™ Guidelines 3-1

 Setting the Data Rate 3-1

Setting the DeviceNet™ Node Address 3-2

Hanging the Pendant Station 3-4

Quick Disconnect Cordsets 3-4

Recommended Strain-Relief Method 3-4

Chapter 4 Operations

Chapter Objectives 4-1

Modes of Operation 4-1

Power-up/Reset Mode 4-1

Run Mode 4-2

Control/Status Communications 4-6

Error Mode 4-7

Resetting the Device 4-7

DeviceNet™ Operations 4-8

Chapter 5 Troubleshooting and Maintenance

Chapter Objectives 5-1

Preventive Maintenance 5-1

Using the LED Indicator 5-2

Replacing a Pilot Light Lamp 5-3

Specifications

Mechanical Ratings A-1

 Materials of Construction A-1

 Shock and Vibration A-1

Environmental Ratings A-2

Ingress Ratings A-2

 Temperature Ratings A-2

 Relative Humidity (Non-Condensing) A-2

Electrical Ratings A-2

 Supply Voltage A-2

 Current Consumption A-2

Input/Output	A-3
DeviceNet™ Connection	A-3
Communications	A-3
Data Rates	A-3
Distances	A-3
Certifications	A-3
Special Notes	A-3

Preface

This manual gives an overview of the Bulletin 800E/F DeviceNet™ Pendant Station and describes how to configure, install, operate and troubleshoot the device on the DeviceNet™ Network.

Intended Audience

This manual is for the individuals responsible for installing, mounting and operating the 800E/F DeviceNet™ Pendant Station in an industrial environment.

You should understand DeviceNet™ Network operations, including how slave devices operate on the network and communicate with a DeviceNet™ Master.

Contents of Manual

This manual is organized as follows:

Chapter	Title	Description
	Preface	Describes the purpose and contents of the manual and the intended audience.
1	Overview	Provides an overview of the 800E/F DeviceNet™ Pendant Station and its features.
2	Quick Start	Describes how to get the 800E/F DeviceNet™ Pendant Station operating on the network.
3	Installation and Mounting	Describes how to configure, mount and install the 800E/F DeviceNet™ Pendant Station on the DeviceNet™ Network.
4	Operations	Describes 800E/F DeviceNet™ Pendant Station operations and other pertinent information.
5	Troubleshooting and Maintenance	Provides information on how to troubleshoot and maintain this device.
A	Specifications	Provides 800E/F DeviceNet™ Pendant Station specifications.

Related Publications

The following table lists DeviceNet™ Network related publications.

Publication Title	Publication No.
DeviceNet™ Cable System Planning and Installation Manual	DN-6.7.2
1756-DNB Scanner Module Configuraiton	1756-6.5.15

EDS Web Site

EDS files are available for downloading at:
www.ab.com/networks/eds/

Overview of DeviceNet™ Pendant Station

Chapter Objectives

This chapter provides an overview of the DeviceNet™ Pendant Station and its features. It contains the following sections:

Section	Page
Description	1-1
Summary of Features	1-2
Enclosure Features	1-2
DeviceNet™ Connection	1-3
Typical DeviceNet™ Configuration	1-4
DeviceNet™ Components	1-5
Replacement Parts	1-5

Description

The 800E/F Pendant Station line offers a DeviceNet™ connection for applications where network communication is desired. All of the functionality for the DeviceNet™ interface is contained within the housing. The entire unit is powered from the DeviceNet™ Network. A separate power supply is not required.

The 800E/F DeviceNet™ Pendant Station allows two operators, 1 – input/1 – output.

Summary of Features

- Standard configurations
- NEMA Type 4/4X/13 environmental rating
- Easy installation and startup
- DeviceNet™ connectivity
- Powered by DeviceNet™ connection (no power supply required)
- Available with mini connector
- Integral hanging bracket
- Standard 800E/F legend carrier (800E-18xxxxxx or 800F-18xxxxxx)
- Button guards to protect against inadvertent operation
- Long life LED
- Auto baud
- Auto Device Replace Enabled
- Standard 800E/F operators

Enclosure Features

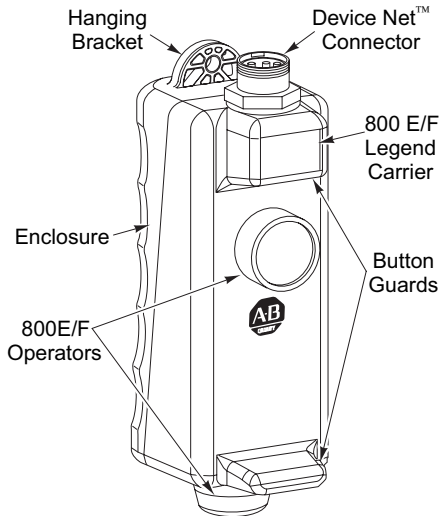

DeviceNet™ Connection

The DeviceNet™ Pendant receives all power and communications through the DeviceNet™ connection. A separate power supply is not required. This is the only external connection to the DeviceNet™ Pendant.

The DeviceNet™ Pendant connects to the DeviceNet™ Network using a mini connector.

DeviceNet™ Sealed Connector

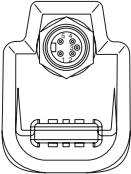
Sealed Connector	Pin #	Signal	Function	Color
	1	SHIELD	SHIELD	Uninsulated
	2	VDC+	Power Supply	Red
	3	COM	Common	Black
	4	CAN_H	Signal High	White
	5	CAN_L	Signal Low	Blue

Typical DeviceNet™ Configuration

A DeviceNet™ Network supports multiple Pendant devices and allows them to communicate with other network devices (up to 64).

The DeviceNet™ Pendant operates on the network as a slave device. It does not initiate communications except for change-of-state, duplicate I/O messages and a node address check on power-up. The master writes data to, and receives data back from, the DeviceNet™ Pendant.

The following Device Net™ configuration shows a variety of products operating as slaves to a PLC-5 controller with a 1771-SDN DeviceNet™ Scanner Module.

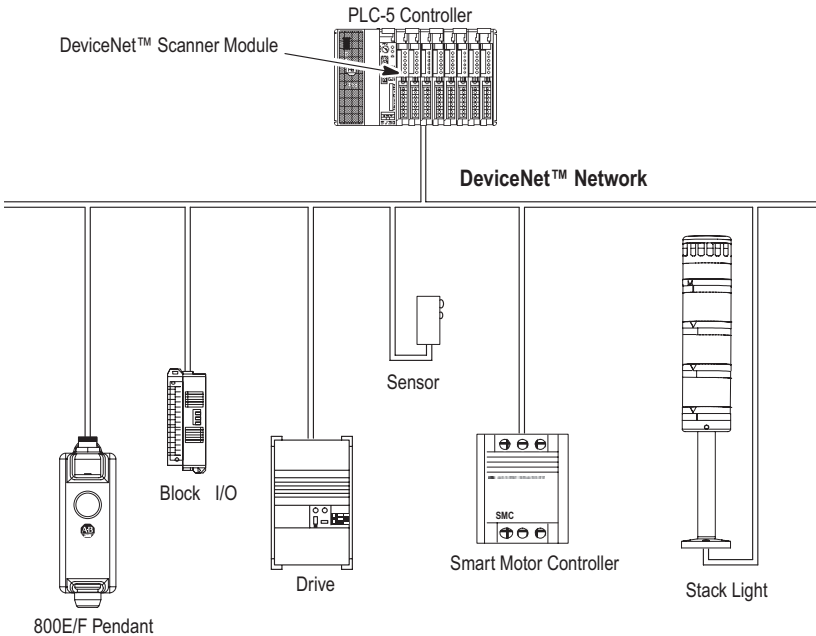

DeviceNet™ Components

DeviceNet™ Cables and components are available from Allen-Bradley as separate catalog numbers.

It is your responsibility to install and implement the DeviceNet™ Network and supported devices according to the DeviceNet™ guidelines.

Replacement Parts

The DeviceNet™ Pendant stations come with all the parts required to install and use the product. The installer needs only to supply the mounting hardware and cabling.

Replacement parts for 800E/F components (operators and replacement lamps) are available as separate catalog numbers. Refer to the Industrial Controls Catalog or 22 mm Push Button Selection Guide.

Quick Start

Chapter Objectives

This chapter provides the necessary steps to get the DeviceNet™ Pendant Station operating on the network. It contains the following sections:

Section	Page
Data Rate Configuration	2-1
Node Address Configuration	2-1
Connection to the Network	2-2
Pendant Station Parameter Configuration	2-2
Scanner Configuration	2-4

Data Rate Configuration

This device is Auto Baud enabled. There is no need to configure data rate.

Node Address Configuration

Node address is set through node commissioning.

For more information on node address configuration, please see Chapter 3 – Installation and Mounting (Setting the DeviceNet™ node address).

Connection to the Network

Wire the DeviceNet™ Pendant Station to an operating network. It will be connected with the mini connector. The device is fully powered by the network.

For more information on system installation, please refer to the DeviceNet™ Cable System – Planning and Installation Manual (Publication DN-6.7.2).

Pendant Station Parameter Configuration

In order for proper operation, the parameters must be configured. The parameters can be configured using RSNetWorx for DeviceNet™.

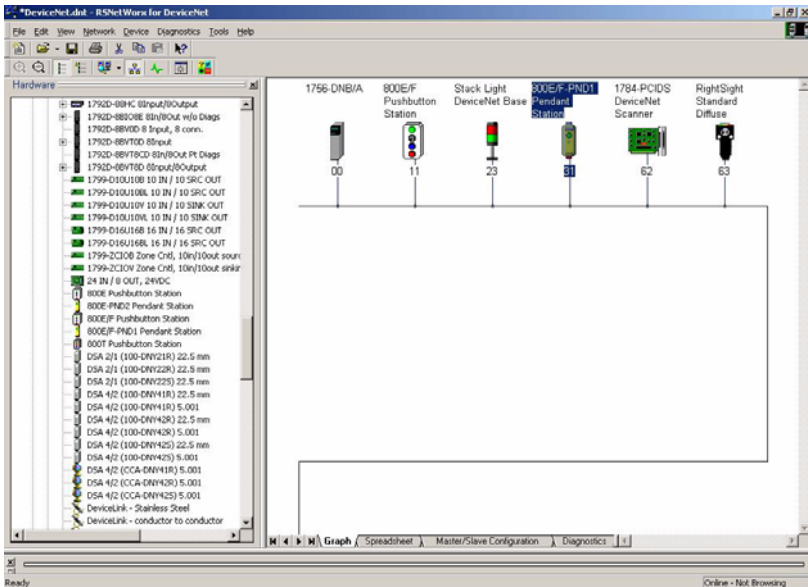

To access the parameter configuration screen from the Online view, double click on the 800E/F Pendant Station Icon.

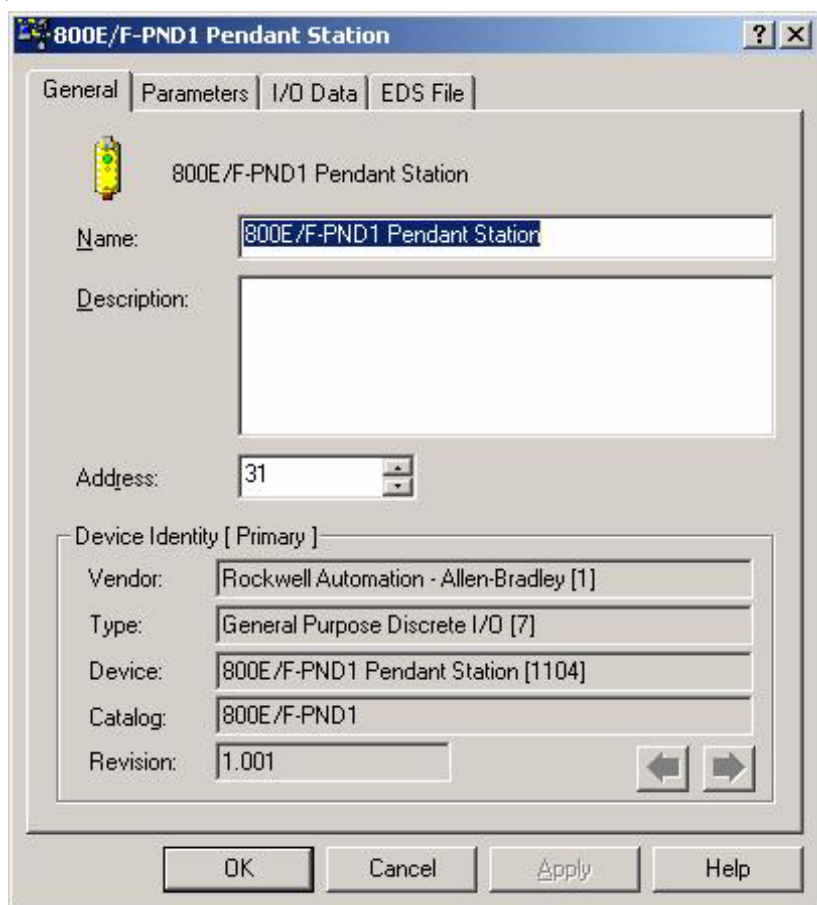

Click on the Device Parameters tab.

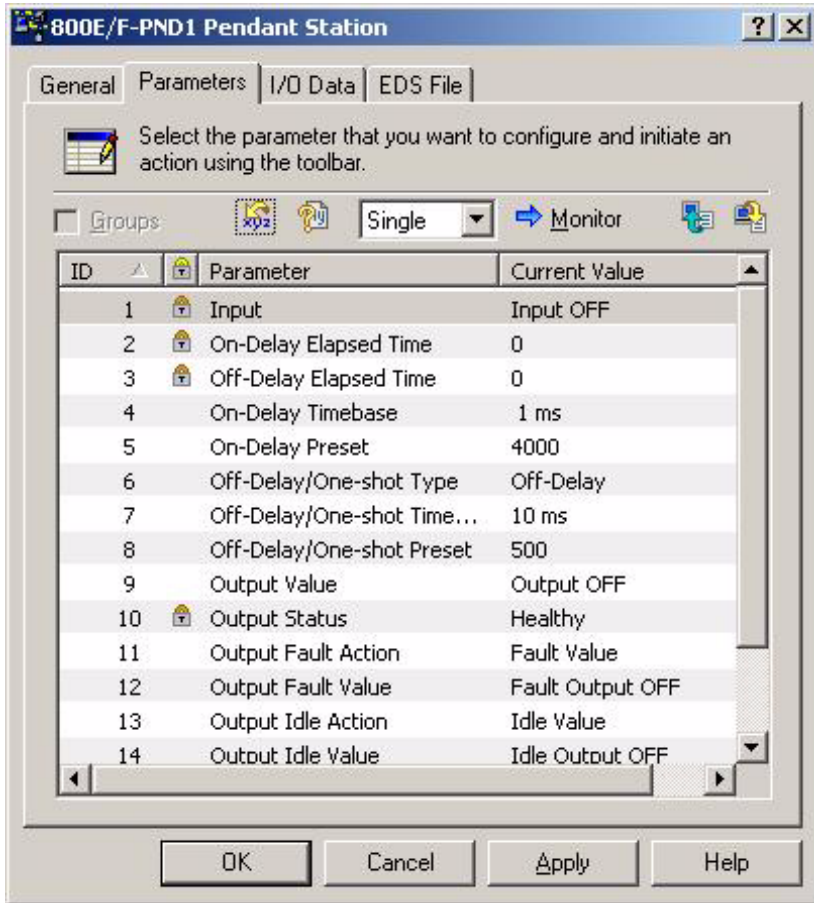

For more information on device configuration, please see Chapter 4 – Operations and the RSNetWorx for DeviceNet™ documentation.

Scanner Configuration

In order for proper operation, the scanner must be configured. The following graphics show the configuration of a 1756-DNB from the RSNetWorx for DeviceNet™ Software.

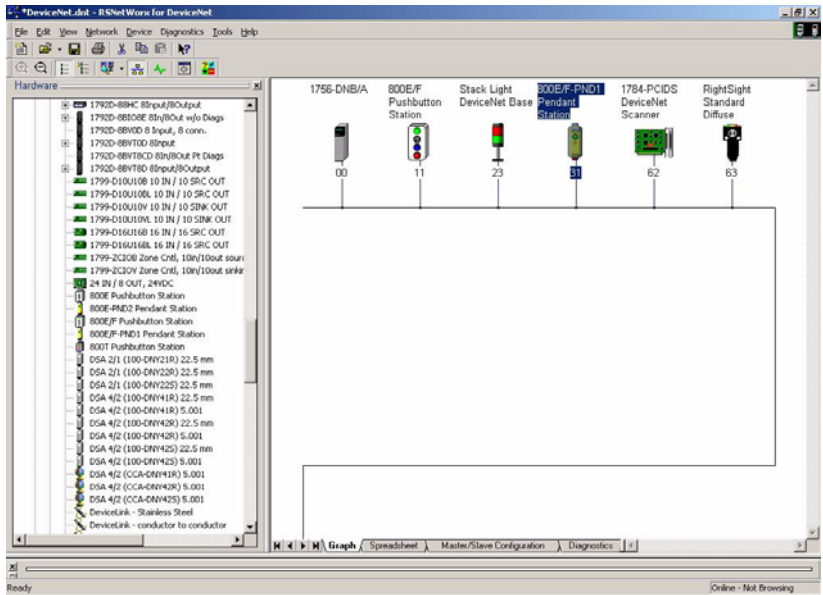

To access the Scanner Module Configuration screen from an Online view, double click on the 1756-DNB Scanner Icon.

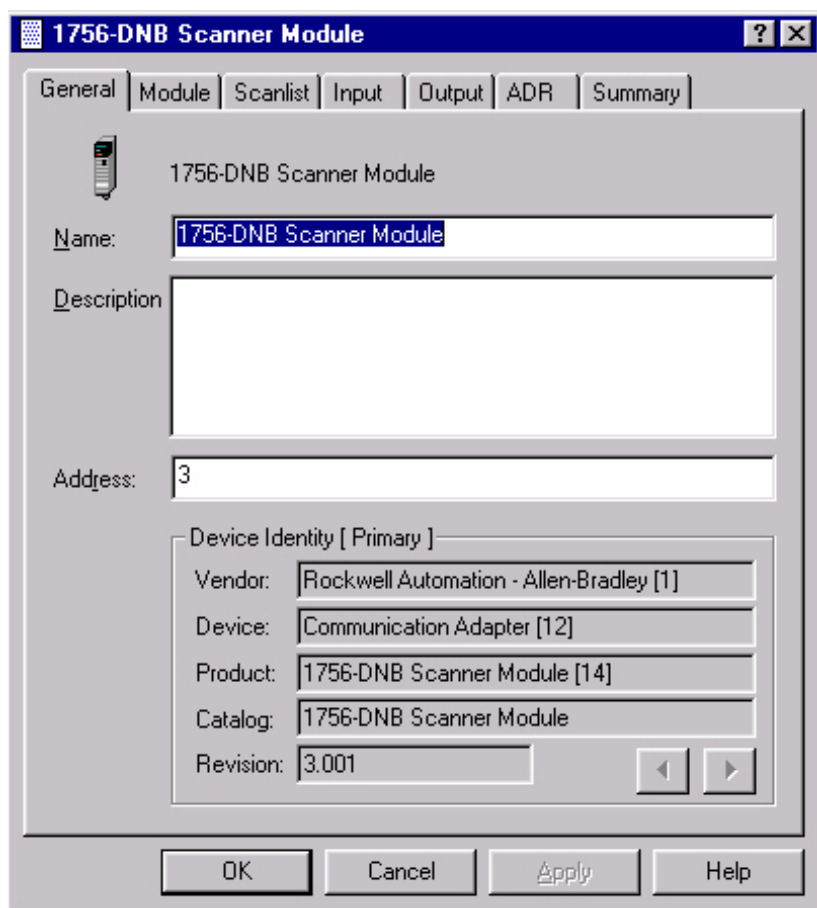

To access the Scanlist Editor, click on the Scanlist tab.

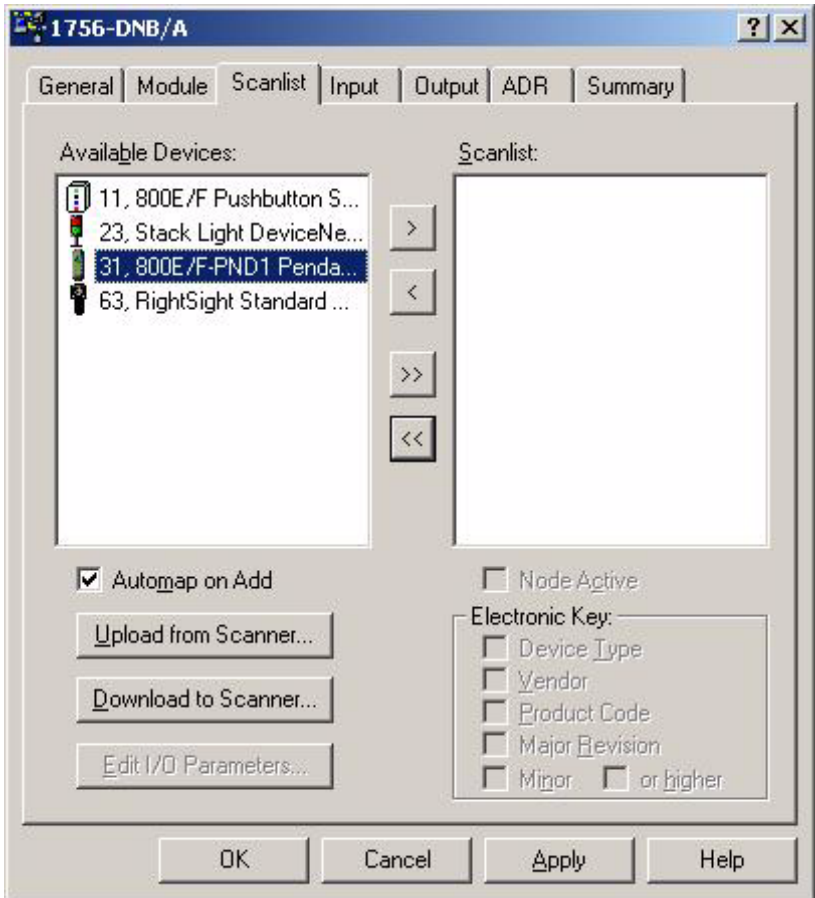

Add the 800E/F Pendant Station to the Scanlist. Select the Device in the Available Devices List. To have the software automatically assign the I/O addresses, select the Automap on Add selection box. Click on the ">" button.

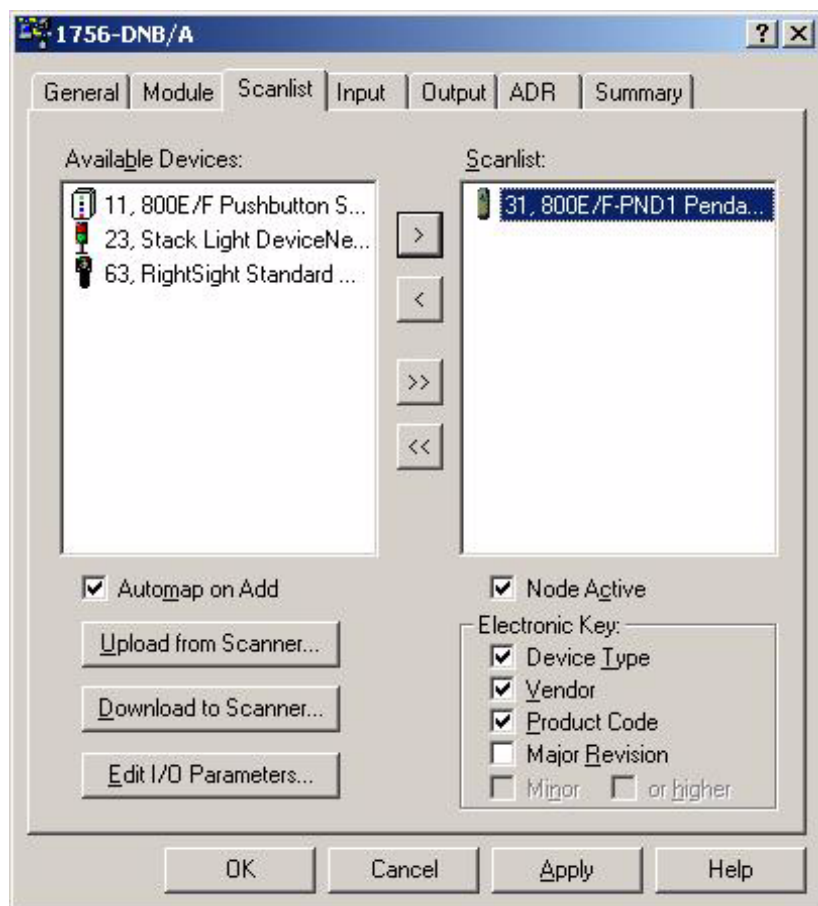

To view/edit I/O parameters, click on Edit I/O Parameters.

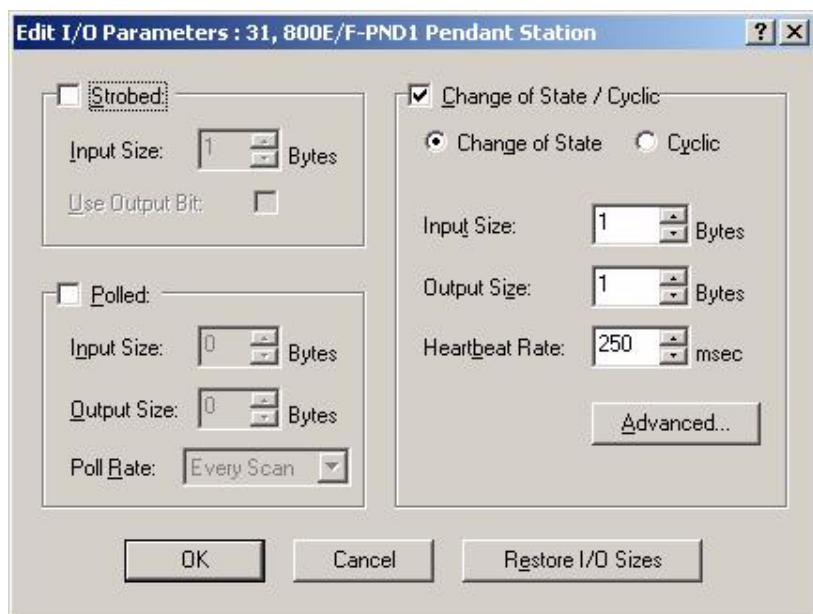

To view/edit the mapping of the Input data, select the Input tab.

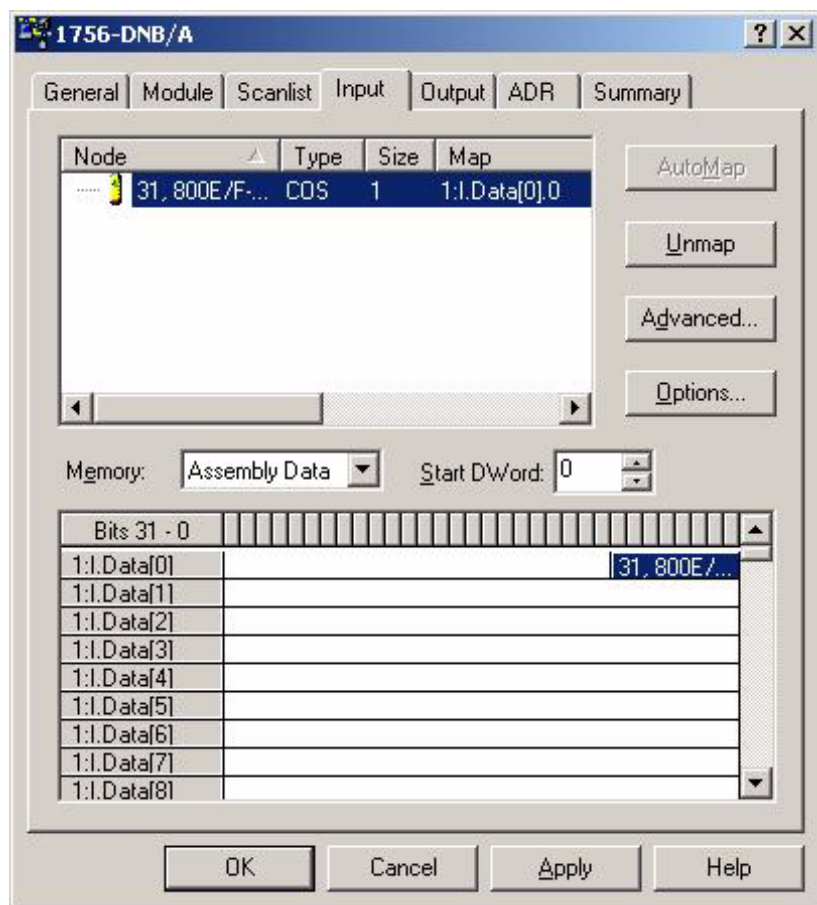

To view/edit the mapping of the Output data, select the Output tab.

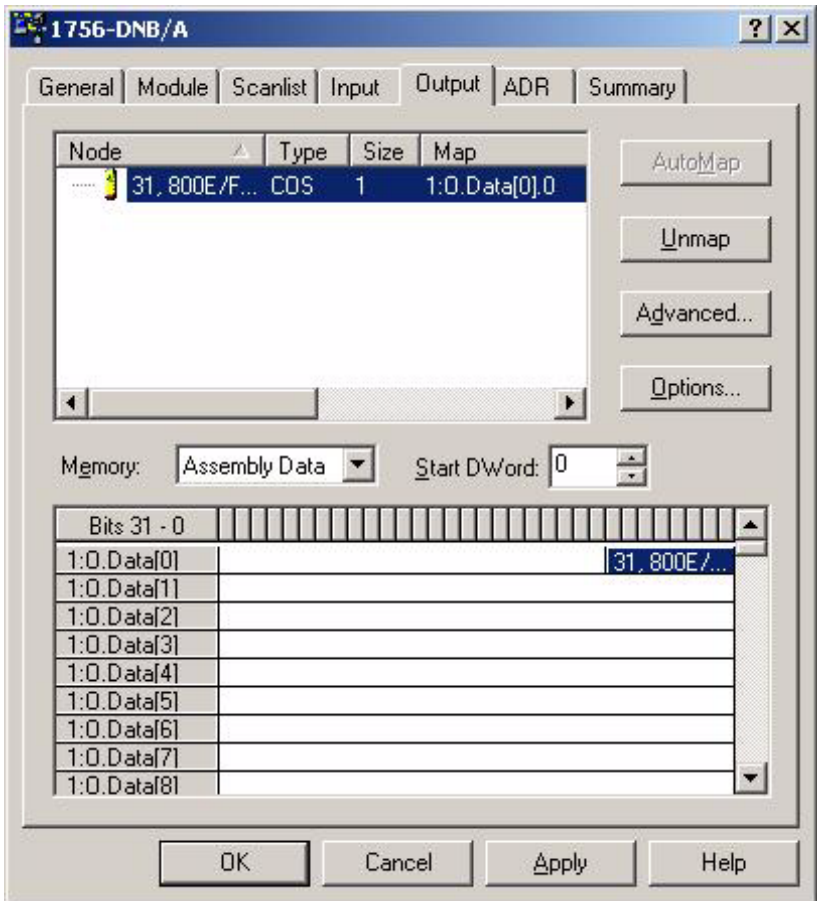

To view/edit the auto device replacement parameters, click on the ADR tab. Select the Enable Auto-Address Recovery box. Click on Load Device Config. Select Configuration Recovery and Auto Address Recovery.

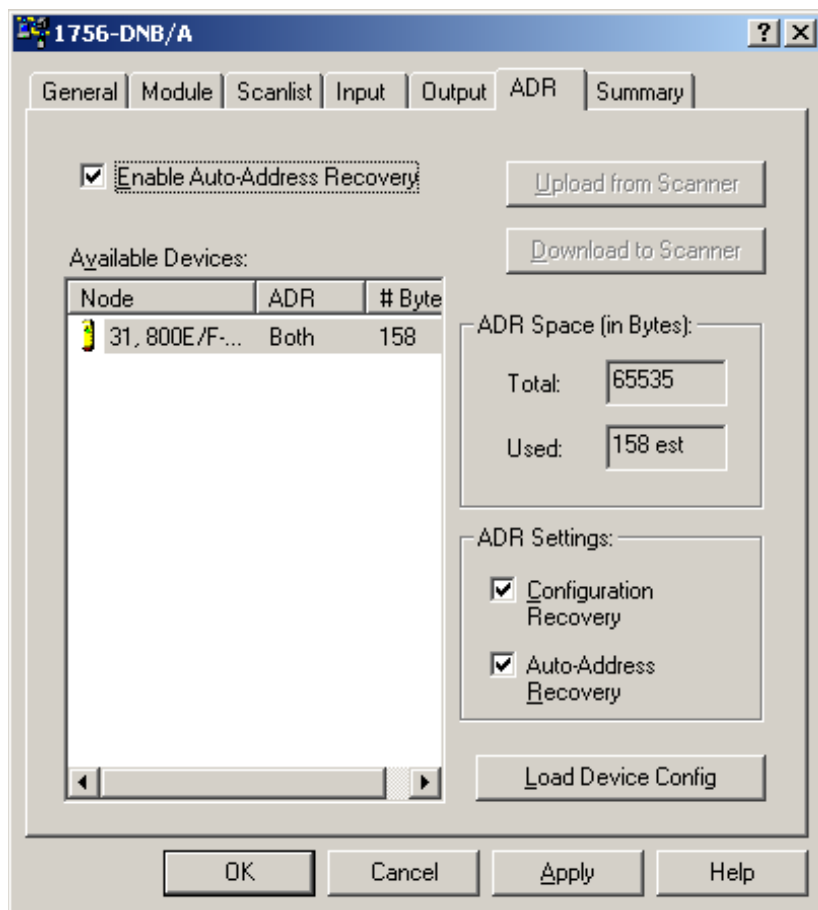

For more information on scanner configuration, please refer to the DeviceNet™ Scanner Configuration Manual (Publication 1756-6.5.15 for the ControlLogix Platform, Publication 1747-6.5.2 for the SLC 500 Platform, or Publication 1711-6.5.118 for the PLC 5 Platform).

Installation and Mounting

Chapter Objectives

This chapter describes how to install and mount a standard or custom DeviceNet™ Pendant Station. It contains the following sections:

Section	Page
DeviceNet™ Guidelines	3-1
Equipment Needed	3-1
Setting the DeviceNet™ Node Address	3-2
DeviceNet™ Pendant Dimensions	3-3
Hanging the Pendant Station	3-4
Recommended Strain-Relief Method	3-4

DeviceNet™ Guidelines

It is your responsibility to install and implement the DeviceNet™ Network and supported devices according to the DeviceNet™ guidelines.

Equipment Needed

There is no need to open the enclosure. The only tools required are for installing a hanging cable.

Setting the Data Rate

This device contains Autobaud functionality, it will automatically detect the network data rate and synchronize to it.

The data rate determines the maximum length of the DeviceNet™ Cable.

Data Rate	Cable Length (Maximum)
125KB	500 m (1600 ft)
250KB	200 m (600 ft)
500KB	100 m (300 ft)
Autobaud	See above, based on data rate of connected network

Setting the DeviceNet™ Node Address

The Node Address for the 800E/F Pendant Stations must be set through Node Commissioning. The factory default is Node 63.

To set the DeviceNet™ Node Address:

1. Start RSNetWorx and select TOOLS from the Menu Bar.
2. Select Node Commissioning. The following screen will appear.

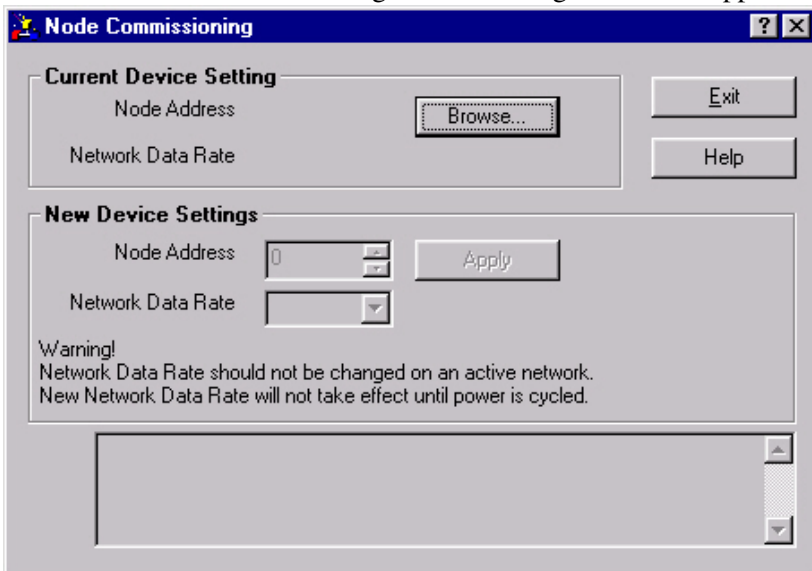

3. Select Browse and select the Pendant Station at Node 63.
4. Change the Node Address to the desired address and click on Apply.

DeviceNet™ Pendant Dimensions

Figure 3.1 shows the dimensions of the Pendant Stations. Dimensions in millimeters (inches). Dimensions are not intended to be used for manufacturing purposes.

Figure 3.1 Pendant Station Dimensions

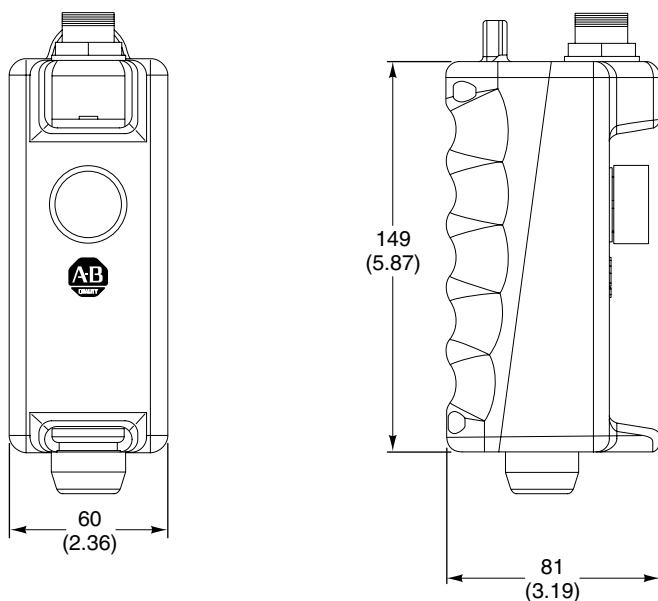

Hanging the Pendant Station

Dimensions in millimeters (inches). Dimensions are not intended to be used for manufacturing purposes.

Figure 3.2 Pendant Mounting

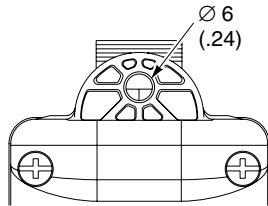

Quick Disconnect Cordsets

Standard 4-Pin Straight Quick Disconnect Cable-Mini		DeviceNet™ 5-Pin Straight Quick Disconnect Cable-Mini	
Length	Cat. No.	Length	Cat. No.
1.8 m	889N-F4AF-6F	1 m	1485R-P1N5-C
3.7 m	889N-F4AF-12F	2 m	1485R-P2N5-C
6.1 m	889N-F4AF-20F	3 m	1485R-P3N5-C

For more information on cabling options, please refer to DeviceNet™ Catalog DN-2.15 or Sensor Catalog C113.

Recommended Strain-Relief Method

1/8 in. diameter wire rope/aircraft cable through eyelet of base, crimped into a loop/eye with aluminum duplex sleeve.

Operations

Chapter Objectives

This chapter contains the following sections:

Section	Page
Modes of Operation	4-1
Resetting the Device	4-7
DeviceNet™ Operations	4-8

Modes of Operation

The 800E/F DeviceNet™ Pendant Station has 3 operating modes:

- Power-up/Reset Mode
- Run Mode
- Error Mode

Power-up/Reset Mode

During a power-up or reset, the 800E/F DeviceNet™ Pendant Station:

1. Clears output (turns output off).
2. Performs power-up diagnostic tests.
3. If Autobaud is enabled, device synchronizes to the network.
4. Performs Duplicate MAC ID check.

If a duplicate node occurs, the output remains off and the device goes to “Bus Off”. You must cycle power to clear the error.

Run Mode

After a successful power-up or reset, the 800E/F DeviceNet™ Pendant Station enters run mode and operates as a slave device to a master device.

Configuration is done over the network using DeviceNet™ Manager or RSNetWorx for DeviceNet™ software.

ON-DELAY TIMEBASE – Parameter 4

In normal operation, the device shall permit configuration of an on-delay timer for the input. The On-Delay timer is always enabled for debounce on inputs. The device shall permit configuration of the On-Delay Timebase. The default timebase is 1 ms.

Value	Timebase
0	1 ms
1	10 ms

ON-DELAY PRESET – Parameter 5

In normal operation, the device shall permit configuration of the On-Delay Preset. When this value is reached, the On-Delay timer output is set. It is user-configurable with a maximum value of 65,535. The default for the Preset is 2.

Value	Preset
User Configurable	2 – 65,535

OFF-DELAY/ONE-SHOT TYPE – Parameter 6

In normal operation, the device shall permit configuration of an off-delay/one-shot timer for the input. The default value for Off-Delay/One-Shot Type is disabled.

Value	Function
0	Disabled
1	One-Shot
2	Not Supported
3	Off-Delay

OFF-DELAY/ONE-SHOT TIMEBASE – Parameter 7

In normal operation, the device shall permit configuration of the Off-Delay/One-Shot Timebase. The default timebase is 1 ms.

Value	Timebase
0	1 ms
1	10 ms

OFF-DELAY/ONE-SHOT PRESET – Parameter 8

In normal operation, the device shall permit configuration of the Off-Delay/One-Shot Preset. When this value is reached, the Off-Delay/One-Shot Timer output is set. It is user-configurable with a maximum value of 65,535. The default for the Preset is 0.

Value	Preset
User Configurable	0...65,535

OUTPUT VALUE – Parameter 9

In normal operation, the device shall permit output to be turned on and off. The default for the Output Value is Output Off.

Value	Output Value
0	Output Off
1	Output On

Important: If the device is connected to a master with I/O messaging, the I/O messaging will overwrite this command.

OUTPUT FAULT ACTION – Parameter 11

In normal operation, the device shall permit configuration of the Output Fault Action. This tells the device what to do with the output in the case of a fault state. If Fault Value is selected, the device refers to parameter 12, Output Fault Value, for action on a fault. The default for Output Fault Value is Fault Value.

Value	Fault Action
0	Fault Value
1	Hold Last State

OUTPUT FAULT VALUE – Parameter 12

In normal operation, the device shall permit configuration of the Output Fault Value. If parameter 11, Output Fault Action is set to Fault Value, this parameter tells the device what to do with the output in case of a fault state. The default for Output Fault Value is Fault Output Off.

Value	Fault Value
0	Fault Output Off
1	Fault Output On

OUTPUT IDLE ACTION – Parameter 13

In normal operation, the device shall permit configuration of the Output Idle Action. This tells the device what to do with the output in the case of an idle state. If Idle Value is selected, the device refers to parameter 14, Output Idle Value, for action on an idle state. The default for Output Idle Value is Idle Value.

Value	Idle Action
0	Idle Value
1	Hold Last State

OUTPUT IDLE VALUE – Parameter 14

In normal operation, the device shall permit configuration of the Output Idle Value. If parameter 13, Output Idle Action is set to Idle Value, this parameter tells the device what to do with the output in the case of an idle state. The default for Output Idle Value is Idle Output Off.

Value	Idle Value
0	Idle Output Off
1	Idle Output On

AUTOBAUD – Parameter 15

In normal operation, the device shall permit disabling of the Autobaud feature. The default value for this parameter is Enabled.

Value	Function
0	Enabled
1	Disabled

Control/Status Communications

The I/O messaging is set up through client/server connections at power-up by the master device. Both Change-of-State (COS) and Strobe messaging connections are supported by this device. COS communications with the DeviceNet™ interface will consist of a single input byte and a single output byte. They are defined as below.

INPUT/STATUS BYTE

Bit Number	Function When = 1	Function When = 0
7	N/A	N/A
6	N/A	N/A
5	N/A	N/A
4	N/A	N/A
3	Output Status - On	Output Status - Off
2	N/A	N/A
1	N/A	N/A
0	Input 1 On	Input 1 Off

OUTPUT BYTE

Bit Number	Function When = 1	Function When = 0
7	N/A	N/A
6	N/A	N/A
5	N/A	N/A
4	N/A	N/A
3	N/A	N/A
2	N/A	N/A
1	N/A	N/A
0	Output 1 Execute	Output 1 Idle

Error Mode

Errors are critical and non-critical.

Error Type	Description
Critical (non-recoverable)	Failure of diagnostic tests during power-up/reset mode Duplicate node address detected
Non-Critical (recoverable)	I/O connection timeout

See the troubleshooting chart in Chapter 5 for details on how to recover from an error.

Resetting the Device

To reset the 800E/F DeviceNet™ Pendant Station, you must cycle power to the unit or disconnect and reconnect the DeviceNet™ Cabling.

DeviceNet™ Operations

The Allen-Bradley 1747-SDN, 1756-DNB, and 1771-SDN DeviceNet™ Scanner Modules are master devices on the DeviceNet™ Network. The 800E/F Pendant Station supports the Master/Slave Connection Set for master/slave communications on the DeviceNet™ Network.

To communicate with 800E/F Pendant Station, the DeviceNet™ Scanner Module must be configured with the Pendant Station:

- Node Address
- Input bytes (1)
- Output bytes (1)

The DeviceNet™ Scanner Module:

- Connects to the 800E/F Pendant Station slave device
- Performs appropriate connection configuration
- Uses Change-of-State or Strobe Messaging for the 800E/F Pendant Station I/O

Troubleshooting and Maintenance

Chapter Objectives

This chapter contains the following sections:

Section	Page
Preventive Maintenance	5-1
Using the LED Indicator	5-2
Replacing a Pilot Light Lamp	5-3

Preventive Maintenance

- Prevent accumulation of dust and dirt by:
 - keeping enclosure clean
 - keeping enclosure cover closed
- Periodically check for loose connections.



ATTENTION: To avoid shock hazard, remove incoming power before checking connections.

Using the LED Indicator

The LED provides status information on Pendant Station operations. The LED is visible when the enclosure cover is removed.

The troubleshooting chart shows LED indications. It also shows how to use the LED to detect and correct common operating problems.

LED		What It Means:	What To Do:
Color	State		
None		Pendant Station is not receiving input power.	Check DeviceNet™ power and cable connections and the power connection on the DeviceNet™ connector.
Red	Solid	Diagnostics failed on power-up/reset.	Internal fault. Reset device. If fault still exists, return Pendant Station for repair.
Red	Flashing	Duplicate DeviceNet™ node address. Two nodes cannot have the same address.	Set Mac ID through Node Commissioning. (See “Setting the DeviceNet™ Node Address” on page 3-2.)
		IO connection timeout.	Reset device.
Green	Solid	Normal operating state and device is allocated to a master device.	No action required.
Green	Flashing	Device is online and operating properly, but not allocated to master.	Check DeviceNet™ master for correct Pendant Station configuration information (node address, input bytes, output bytes).
		Device is in idle state.	Check DeviceNet™ master for proper operation.

The LED does not indicate the following malfunctions.

Problem	What It Means:	What To Do:
Switch or button operators do not function.	Loose wiring	Check wiring and cable connections.
	Incorrect address	Check address setting via Network Who.
	Faulty contacts, switch or button	Use an ohmmeter to verify opening/closing of contacts.

Replacing a Pilot Light Lamp

Pilot light lamps can be replaced easily by opening enclosure.

To replace a pilot light lamp:



ATTENTION: To avoid electrical shock or unintended operation of the equipment, remove power.

1. Remove lens cap from the pilot light.
2. Remove lamp from socket. If necessary, use lamp removal tool – Cat. No. 800F-ALR1.



ATTENTION: Do not use a screwdriver or other metal object to remove lamp.

3. Carefully insert new LED module into latch.



ATTENTION: Use only 24V LED modules.



ATTENTION: Before replacing the lens cap, be sure the lamp is seated properly or a short may result.

4. Replace the lens cap.
5. Check for proper operation.

Specifications

Mechanical Ratings

Materials of Construction

Table A.A Materials of Construction

Part Description	Material	Relative Thermal Index	Flammability Rating
Enclosure	PBT/PC Blend Thermo plastic	248° F (120° C)	94-5VA
Enclosure Gasket	Nitrile 70 Durometer	—	—
Mini Connector	Shell – Nylon Insert – PVC Contact – Brass w/ Gold Flash Over Palladium Nickel Plating Gasket – Neoprene Shore 'A'	—	—
Screws	Stainless Steel AISI 304	—	—
800E/F Operators	Misc. – See Industrial Control Catalog	—	—

Shock and Vibration

MECHANICAL SHOCK

1. Wave Shape – 1/2 cycle sine wave
2. Duration – 11 ms
3. Frequency – 3 times in each axis
4. Maximum Allowable G Force:
Operational 100 G

MECHANICAL VIBRATION

1. Axis Definitions – 3 mutually perpendicular axes
2. Frequency – 10...2000 Hz
3. Duration – 2 hours each axis
4. Maximum Allowable G Force:

Operational	10 G
-------------	------

Environmental Ratings

Ingress Ratings

All Units – Type 4/4X/13, IP66.

Dependent upon rating of installed devices.

Temperature Ratings

Operating Temperature	-13° F...+131° F (-25° C...+55° C)
Storage Temperature	-40° F...158° F (-40° C...+70° C) (185° F (85° C) Max. for 24 hours)

Relative Humidity (Non-Condensing)

0...95% Humidity

Electrical Ratings

Supply Voltage

11...25V DC with reverse polarity protection. Class 2 Power Source required.

Current Consumption

50 mA RMS, 100 mA peak @ 24V DC.

Input/Output

The voltage on I/O is 24V DC. 1 input and 1 output shall be supported. Most 800E/F operators will be supported.

DeviceNet™ Connection

A mini connector will be available. It consists of five 18 AWG wires for power and communications.

Communications

Data Rates

125 KB, 250 KB, and 500 KB

Distances

500 m (1600 ft)	125 KB
200 m (600 ft)	250 KB
100 m (300 ft)	500 KB

Certifications

UL, CUL, and CE marked for all applicable directives. CE directives include EN55011, EN50081-2, EN50082-2 and EN60947-5-1. This product is intended for use in an industrial environment.

Special Notes

Please refer to the Industrial Controls Catalog for 800E/F operator-specific information.

Reach us now at www.rockwellautomation.com

Wherever you need us, Rockwell Automation brings together leading brands in industrial automation including Allen-Bradley controls, Reliance Electric power transmission products, Dodge mechanical power transmission components, and Rockwell Software. Rockwell Automation's unique, flexible approach to helping customers achieve a competitive advantage is supported by thousands of authorized partners, distributors and system integrators around the world.

Americas Headquarters, 1201 South Second Street, Milwaukee, WI 53204 USA, Tel: (1) 414 382 2000, Fax: (1) 414 382-4444
European Headquarters SANV, avenue Hermann Debroux, 46, 1160 Brussels, Belgium, Tel: (32) 2 863 06 00, Fax: (32) 2 863 06 40
Asia Pacific Headquarters, 27/F Citicorp Centre, 19 Whitfield Road, Causeway Bay, Hong Kong, Tel: (852) 2897 4788, Fax: (852) 2508 1846



**Rockwell
Automation**