

SIRCO MOT AT

Remotely operated load break switches
from 125 to 3200 A

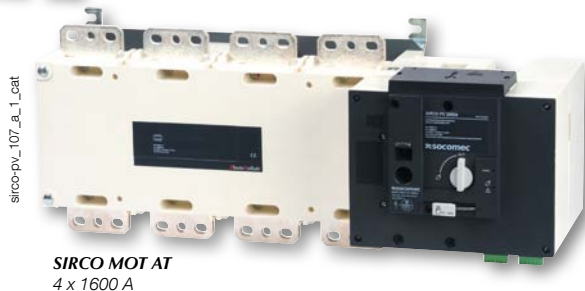

SIRCO MOT AT
4 x 630 A



SIRCO MOT AT
4 x 1600 A

The solution for

- > Building
- > Network coupling
- > Emergency disconnection



Strong points

- > High performance breaking capacity - up to 3200 A 690 VDC
- > Motorised remote operation
- > Manual emergency operation

Compliance with standards

- > IEC 60947-3
- > EN 60947-3
- > NBN EN 60947-3
- > BS EN 60947-3
- > GB 14048



Function

SIRCO MOT AT are remotely operated 3/4 pole load break switches. They make and break under load conditions via remote operation and provide safety isolation for any low voltage circuit.

This is ensured via volt-free contacts using either a pulse or contactor logic.

Advantages

Extended power range

These products offer great power flexibility thanks to a wide power supply range of 208 to 277 VAC $\pm 20\%$.

Integrated auxiliary contacts

As part of the product monitoring function, the SIRCO MOT AT enables the transmission of information relating to their position.

This is possible thanks to the standard integration of an auxiliary contact for each position.

General characteristics

- 2 stable positions (I, 0)
- One auxiliary contact per position as standard
- Positive break indication
- AUTO/MANU selector
- Manual emergency operation
- Padlocking in position 0 (position I optional).
- Ratings: 125 to 3200 A

References

SIRCO MOT AT

Rating (A) / Frame size	N° of poles	Power supply voltage	Switch body	Terminal screens	Terminal shrouds
125 A / B3	3 P	230 VAC	9915 3012	3 P 1509 3012	3 P 2694 3014
	4 P		9915 4012		
160 A / B3	3 P		9915 3016	4 P 1509 4012	4 P 2694 4014
	4 P		9915 4016		
250 A / B4	3 P		9915 3025	3 P 1509 3025	3 P 2694 3021
	4 P		9915 4025		
400 A / B4	3 P		9915 3040	4 P 1509 4025	4 P 2694 4021
	4 P		9915 4040		
630 A / B5	3 P		9915 3063	3 P 1509 3063	3 P 2694 3051
	4 P		9915 4063		
800 A / B6	3 P		9915 3080	4 P 1509 4063	4 P 2694 4051
	4 P		9915 4080		
1000 A / B6	3 P		9915 3100	3 P 1509 3080	3 P 2694 3051
	4 P		9915 4100		
1250 A / B6	3 P		9915 3120	4 P 1509 4080	4 P 2694 4051
	4 P		9915 4120		
1600 A / B7	3 P		9915 3160	3 P 1509 3160	3 P 2694 3051
	4 P		9915 4160		
2000 A / B8	3 P		9915 3200	4 P 1509 4160	4 P 2694 4051
	4 P		9915 4200		
2500 A / B8	3 P	9915 3250	3 P 1509 3200	3 P 2694 3051	
	4 P	9915 4250			
3200 A / B8	3 P	9915 3320	4 P 1509 4200	4 P 2694 4051	
	4 P	9915 4320			

Accessories

Terminal shrouds

Use

Protection IP2X against direct contact with terminals or connecting parts.

Advantages

Perforations allow remote thermographic inspection without the need to remove the shrouds.

Rating (A)	Frame size	N° of poles	Position	Reference
125 ... 200	B3	3 P	Upstream or downstream	2694 3014 ⁽¹⁾
125 ... 200	B3	4 P	Upstream or downstream	2694 4014 ⁽¹⁾
250 ... 400	B4	3 P	Upstream or downstream	2694 3021 ⁽¹⁾
250 ... 400	B4	4 P	Upstream or downstream	2694 4021 ⁽¹⁾
630	B5	3 P	Upstream or downstream	2694 3051 ⁽¹⁾
630	B5	4 P	Upstream or downstream	2694 4051 ⁽¹⁾

(1) For complete protection, order the reference 2 times.

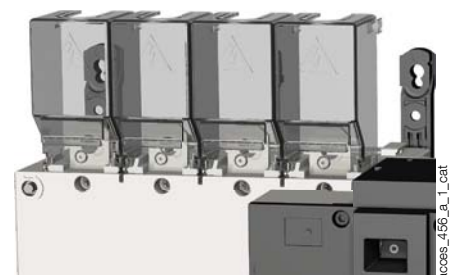

SIRCO MOT AT

Remotely operated load break switches
from 125 to 3200 A

Accessories (continued)

Terminal screens

Use

Upstream and downstream protection from direct contact with terminals or connection parts.

Rating (A)	Frame size	N° of poles	Position	Reference
125 ... 200	B3	3 P	Upstream/downstream	1509 3012
125 ... 200	B3	4 P	Upstream/downstream	1509 4012
250 ... 400	B4	3 P	Upstream/downstream	1509 3025
250 ... 400	B4	4 P	Upstream/downstream	1509 4025
630	B5	3 P	Upstream/downstream	1509 3063
630	B5	4 P	Upstream/downstream	1509 4063
800 ... 1250	B6	3 P	Upstream/downstream	1509 3080
800 ... 1250	B6	4 P	Upstream/downstream	1509 4080
1600	B7	3 P	Upstream/downstream	1509 3160
1600	B7	4 P	Upstream/downstream	1509 4160
2000 ... 3200	B8	3 P	Upstream/downstream	1509 3200
2000 ... 3200	B8	4 P	Upstream/downstream	1509 4200

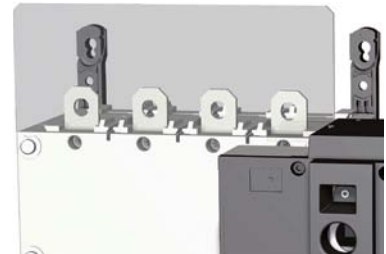

access_453_a1_cat

Copper bar connection kits

Use

Enables:

- To allow connection between the two power terminals of the same pole for 2000 to 3200 A ratings

For 3200 A rating, the connection pieces (part A) are delivered bridged from factory.

Bolt sets must be ordered separately. Further details for these specific accessories are available in the user guide downloadable from www.socomec.com.

Fig. 1

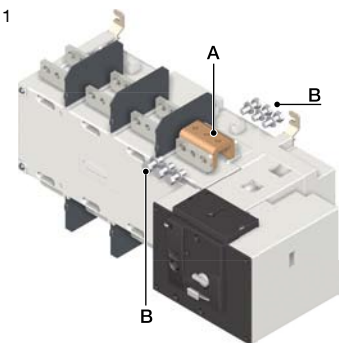

access_454_a1_X_cat

Fig. 2

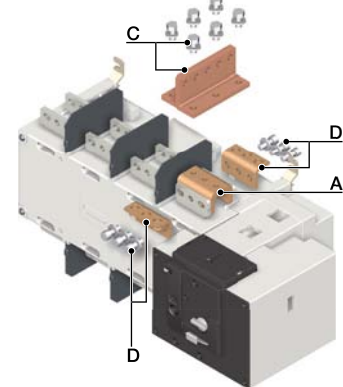

access_455_a1_X_cat

Top or bottom flat connection - Fig. 1

Rating (A)	Part	Fig. 1 - Part	Quantity to order per pole	Reference
2000 ... 2500	Connection	A	1	2619 1200
2000 ... 2500	Screws	B	1	2699 1200
3200	Connection	A		included
3200	Screws	B	1	2699 1200

Top or bottom edgewise connection - Fig. 2

Rating (A)	Part	Fig. 2 - Part	Quantity to order per pole	Reference
2000 ... 2500	Connection	A	1	2619 1200
2000 ... 3200	T piece + bolts	C	1	2629 1200
2000 ... 3200	Bracket + bolts	D	1	2639 1200
3200	Connection	A		included

Autotransformer

Use

Enables a 230 VAC device to be supplied with 400 VAC.

Rating (A)	Frame size	Reference
125 ... 3200	B3 ... B8	1599 4064

DC power supply

Use

For power supplied from one 12 or 24 VDC source.
To be positioned as close as possible to DC power supply source.

Rating (A)	Frame size	Operating voltage	Reference
125 ... 3200	B3 ... B8	12 VDC / 230 VAC	1599 5012
125 ... 3200	B3 ... B8	24 VDC / 230 VAC	1599 5112

Auxiliary contact

Use

Pre-break and signalling of positions I:
Up to 2 NO/NC auxiliary contacts
(1 fitted as standard).
Low level AC: contact us.

Connection to the control circuit

By 6.35 mm fast-on terminal.

Electrical characteristics

30,000 operations.



access_065_a1_cat

Characteristics

Rating (A)	Rated current (A)	Operating current I _o (A)			
		250 VAC AC-13	400 VAC AC-13	24 VDC AC-13	48 VDC AC-13
125 ... 1600	16	12	8	14	6

References

NO/NC changeover contact

Rating (A)	Contact(s)	Reference
125 ... 800	2 nd	1999 1002
800 ... 1600	2 nd	1999 1032
2000 ... 3200	2 nd	Included

2-position padlocking (I-0)

Use

Enables the product to be padlocked in positions 0, I and II (factory fitted).

Rating (A)	Frame size	Reference
125 ... 630	B3 ... B5	9599 0003
800 ... 3200	B6 ... B8	9599 0004



atys_867_a

Key handle interlocking system

Use

Locking of the electrical control and the emergency control in position 0 using a RONIS EL11AP lock (factory fitted).

As standard, locking in position 0.

Optional padlocking in 2 positions: locking in position 0 and 1



atys_868_a

Rating (A)	Frame size	Reference
125 ... 630	B3 ... B5	9599 1006
800 ... 3200	B6 ... B8	9599 1004

SIRCO MOT AT

Remotely operated load break switches
from 125 to 3200 A

Accessories (continued)

Double power supply - DPS

Use

Provides power to the SIRCO MOT from two 230 VAC, 50/60 Hz networks.

Input

- The input is considered as "active" from 200 VAC.
- Maximum voltage: 288 VAC.
- Internal protection: each input is fuse protected (3.15 A).
- Connecting to fixed terminals: maximum 6 mm².
- Modular product: 4 module width.

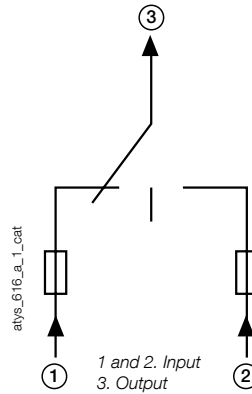

atys_012_a_2_cat

Accessories	Reference
DPS	1599 4001

Mounting spacers

Use

Increases the distance between the rear power terminals and the backplate by 1 cm.

This accessory may also be used to replace the original mounting spacers.



atys_009_a_2_cat

Rating (A)	Frame size	Accessories	Reference
125 ... 630	B3 ... B5	1 set of 2 spacers	1509 0001

Door protective surround

Use

When direct access to the SIRCO MOT front face is required, the door surround can be utilised to provide a clean and safe finish to the panel's cut-out.

Rating (A)	Frame size	Reference
125 ... 630	B3 ... B5	1529 0012
800 ... 3200	B6 ... B8	1529 0080

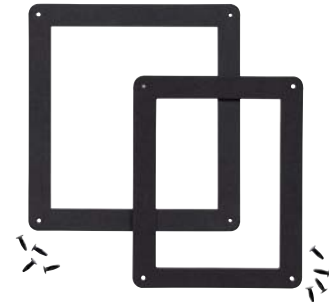

atys_595_a_2_cat

Characteristics according to IEC 60947-3 and IEC 60947-6-1

125 to 630 A / B3 to B5

Thermal current I_{th} at 40°C	125 A	160 A	250 A	400 A	630 A	
Frame size	B3	B3	B4	B4	B5	
Rated insulation voltage U_i (V) (power circuit)	800	800	1000	1000	1000	
Rated impulse withstand voltage U_{imp} (kV) (power circuit)	8	8	12	12	12	
Rated operational currents I_e (A) according to IEC 60947-3						
Rated voltage	Utilisation category	A/B	A/B	A/B	A/B	A/B
415 VAC	AC-21 A / AC-21 B	125/125	160/160	250/250	400/400	630/630
415 VAC	AC-22 A / AC-22 B	125/125	160/160	250/250	400/400	630/630
415 VAC	AC-23 A / AC-23 B	125/125	160/160	200/200	400/400	630/630
500 VAC	AC-20 A / AC-20 B	125/125	160/160	250/250	400/400	630/630
690 VAC	AC-20 A / AC-20 B	125/125	160/160	250/250	400/400	630/630
690 VAC	AC-21 A / AC-21 B	125/125	160/160	200/200	200/200	500/500
690 VAC	AC-22 A / AC-22 B	125/125	125/125	160/160	160/160	400/400
690 VAC	AC-23 A / AC-23 B	63/80	63/80	125/125	125/125	400/400
220 VDC	DC-20 A / DC-20 B	125/125	160/160	250/250	400/400	630/630
220 VDC	DC-21 A / DC-21 B	125/125	160/160	250/250	250/250	630/630
220 VDC	DC-22 A / DC-22 B	125/125	160/160	250/250	250/250	630/630
220 VDC	DC-23 A / DC-23 B	125/125	125/125	200/200	200/200	630/630
440 VDC	DC-20 A / DC-20 B	125/125	160/160	250/250	400/400	630/630
440 VDC	DC-21 A / DC-21 B	125 ⁽¹⁾ /125 ⁽¹⁾	125 ⁽¹⁾ /125 ⁽¹⁾	200 ⁽¹⁾ /200 ⁽¹⁾	200 ⁽¹⁾ /200 ⁽¹⁾	500 ⁽¹⁾ /500 ⁽¹⁾
440 VDC	DC-22 A / DC-22 B	125 ⁽¹⁾ /125 ⁽¹⁾	125 ⁽¹⁾ /125 ⁽¹⁾	200 ⁽¹⁾ /200 ⁽¹⁾	200 ⁽¹⁾ /200 ⁽¹⁾	500 ⁽¹⁾ /500 ⁽¹⁾
440 VDC	DC-23 A / DC-23 B	125 ⁽²⁾ /125 ⁽²⁾	125 ⁽²⁾ /125 ⁽²⁾	200 ⁽²⁾ /200 ⁽²⁾	200 ⁽²⁾ /200 ⁽²⁾	500 ⁽²⁾ /500 ⁽²⁾
Short-circuit capacity						
Rated short-time withstand current 1s. I_{cw} (kA rms)		7	7	9	9	13
Rated peak withstand current in I_{cc} (kA peak)		20	20	30	30	45
Prospective short-circuit current (kA rms)		100	100	50	18	70
Associated fuse rating (A)		125	160	250	400	630
Connection						
Minimum Cu cable cross-section (mm ²)		35	50	95	185	2 x 150
Minimum Cu busbar cross-section (mm ²)						2 x 30 x 5
Maximum Cu cable cross-section (mm ²)		50	95	150	240	2 x 300
Maximum Cu busbar width (mm)		25	25	32	32	50
Min./max. tightening torque (Nm)		9/13	9/13	20/26	20/26	20/26
Switching time (at nominal voltage)						
I-0 or 0-II (s)		0.45	0.45	0.85	0.85	0.85
Power supply						
Min./max. value (VAC)		166/332	166/332	166/332	166/332	166/332
Control supply power demand						
Power supply 230 VAC inrush/nominal (VA)		184/92	184/92	276/115	276/115	276/150
Mechanical characteristics						
Durability (number of operating cycles)		10000	10000	8000	8000	5000
Weight 3 (kg)		5.7	5.7	6.6	6.6	11.4
Weight 4 (kg)		6.9	6.9	7.4	7.4	13.3

(1) 3-pole device with 2 poles in series for the '+' and 1 pole for the '-'.
(2) 4-pole device with 2 poles in series per polarity.

Characteristics according to IEC 60947-3 and IEC 60947-6-1 (continued)

800 to 3200 A / B6 to B8

Thermal current I_{th} at 40°C	800 A	1000 A	1250 A	1600 A	2000 A	2500 A	3200 A
Frame size	B6	B6	B6	B7	B8	B8	B8
Rated insulation voltage U_i (V) (power circuit)	1000	1000	1000	1000	1000	1000	1000
Rated impulse withstand voltage U_{imp} (kV) (power circuit)	12	12	12	12	12	12	12

Rated operational currents I_e (A) according to IEC 60947-3

Rated voltage	Utilisation category	A/B	A/B	A/B	A/B	A/B	A/B	A/B
415 VAC	AC-21 A / AC-21 B	800/800	1000/1000	1250/1250	1600/1600	-/2000	-/2500	-/3200
415 VAC	AC-22 A / AC-22 B	800/800	1000/1000	1250/1250	1600/1600	-/2000	-/2500	-/3200
415 VAC	AC-23 A / AC-23 B	800/800	1000/1000	1250/1250	1250/1250	-/1600	-/1600	-/1600
690 VAC	AC-20 A / AC-20 B	800/800	1000/1000	1250/1250	1600/1600	2000/2000	2500/2500	3200/3200
690 VAC	AC-21 A / AC-21 B	800/800	800/800	800/800	1000/1000	-/2000	-/2500	-/3200
690 VAC	AC-22 A / AC-22 B	800/800	800/800	800/800	1000/1000			
690 VAC	AC-23 A / AC-23 B	200/250	200/250	200/250	500/500			
220 VDC	DC-20 A / DC-20 B	800/800	1000/1000	1250/1250	1600/1600			
220 VDC	DC-21 A / DC-21 B	800/800	1000/1000	1250/1250	1250/1250			
220 VDC	DC-22 A / DC-22 B	800/800	1000/1000	1250/1250	1250/1250			
220 VDC	DC-23 A / DC-23 B	800/800	1000/1000	1250/1250	1250/1250			
440 VDC	DC-20 A / DC-20 B	800/800	1000/1000	1250/1250	1600/1600			
440 VDC	DC-21 A / DC-21 B	800 ⁽¹⁾ /800 ⁽¹⁾	1000 ⁽²⁾ /1000 ⁽²⁾	1250 ⁽¹⁾ /1250 ⁽¹⁾	1250 ⁽¹⁾ /1250 ⁽¹⁾			
440 VDC	DC-22 A / DC-22 B	800 ⁽¹⁾ /800 ⁽¹⁾	1000 ⁽²⁾ /1000 ⁽²⁾	1250 ⁽¹⁾ /1250 ⁽¹⁾	1250 ⁽¹⁾ /1250 ⁽¹⁾			
440 VDC	DC-23 A / DC-23 B	800 ⁽²⁾ /800 ⁽²⁾	1000 ⁽²⁾ /1000 ⁽²⁾	1250 ⁽²⁾ /1250 ⁽²⁾	1250 ⁽²⁾ /1250 ⁽²⁾			

Short-circuit capacity

Rated short-time withstand current 1s. I_{cw} (kA rms)	26	35	50	50	50	50	50
Rated peak withstand current in I_{cc} (kA peak)	55	80	110	120	120	120	120
Prospective short-circuit current (kA rms)	50	100	100	100			
Associated fuse rating (A)	800	1000	1250	2x800			

Connection

Minimum Cu cable cross-section (mm ²)	2 x 185	2 x 240	2 x 60 x 5	2 x 80 x 5	2 x 100 x 10	2 x 100 x 10	2 x 100 x 10
Minimum Cu busbar cross-section (mm ²)	2 x 40 x 5	2 x 50 x 5					
Maximum Cu cable cross-section (mm ²)	2 x 300	4 x 185	4 x 185	6 x 185			
Maximum Cu busbar width (mm)	63	63	63	100	100	100	100
Min./max. tightening torque (Nm)	20/26	20/26	20/26	40/45	40/45	40/45	40/45

Switching time (at nominal voltage)

I-0 or II-0 (s)	1.6	1.6	1.6	1.6	1	1	1
-----------------	-----	-----	-----	-----	---	---	---

Power supply

Min./max. value (VAC)	166/332	166/332	166/332	166/332	166/332	166/332	166/332
-----------------------	---------	---------	---------	---------	---------	---------	---------

Control supply power demand

Power supply 230 VAC inrush/nominal (VA)	460/184	460/184	460/184	460/230	812/322	812/322	812/322
--	---------	---------	---------	---------	---------	---------	---------

Mechanical characteristics

Durability (number of operating cycles)	4000	4000	4000	3000	3000	3000	3000
Weight 3 P (kg)	27.9	27.9	27.9	30.4	50.7	50.7	50.7
Weight 4 P (kg)	32.2	32.2	32.2	34.5	61.6	61.6	61.6

(1) 3-pole device with 2 poles in series for the '+' and 1 pole for the '-'.
(2) 4-pole device with 2 poles in series per polarity.

Dimensions

125 to 630 A

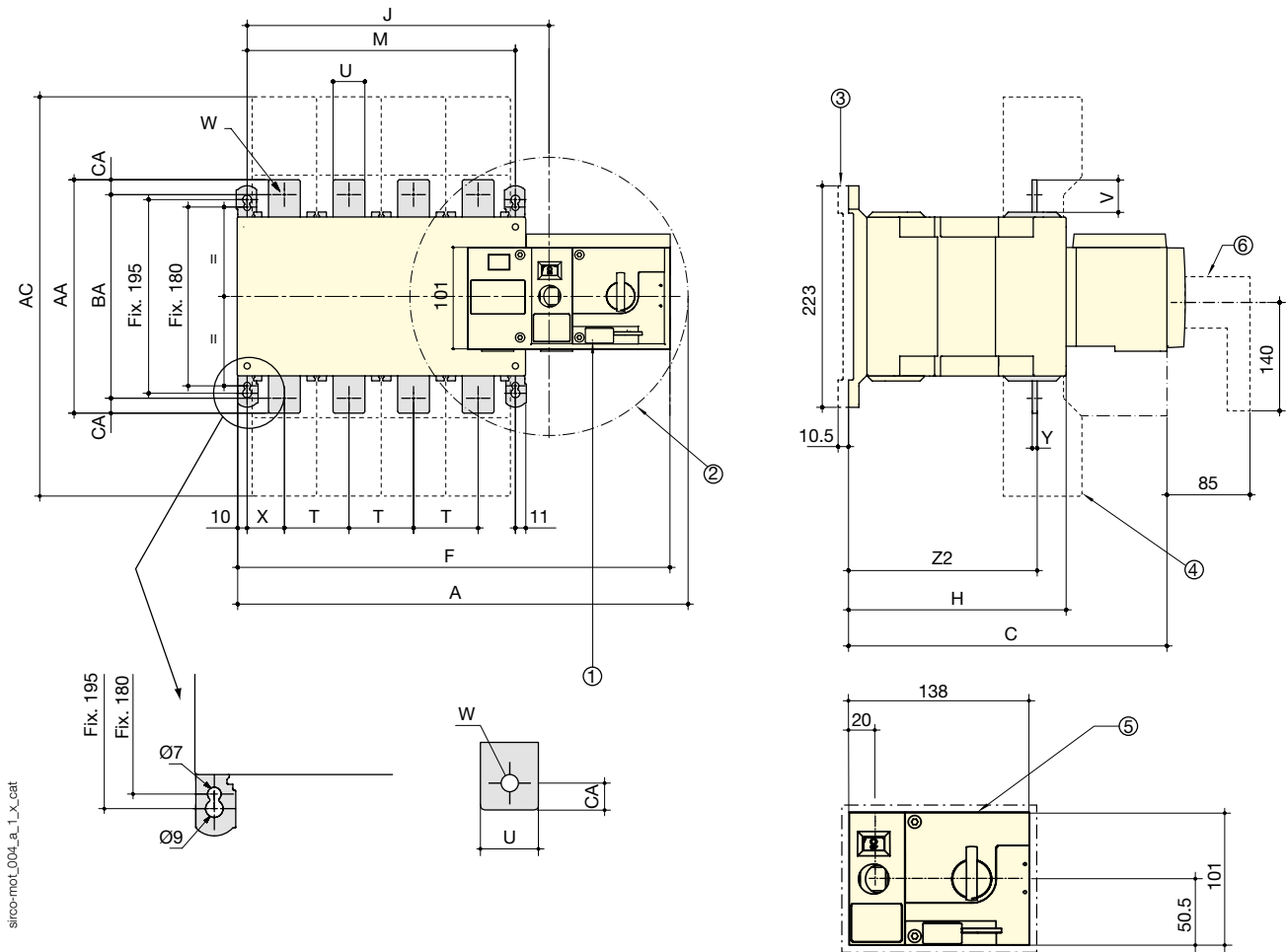

sirco-mot_004_a_1_x_cat

1. Triple padlock tab, 4-8 mm
2. Emergency manual operation: max. handle radius, operating angle 90°
3. Spacers
4. Inter-phase screen
5. Cut out dimension
6. Manual emergency operation

Rating (A) / Frame size	Overall dimensions			Terminal shrouds	Case					Switch mounting		Connection										
	A 3p.	A 4p.	C	AC	F 3p.	F 4p.	H	J 3p.	J 4p.	M 3p.	M 4p.	T	U	V	W	X 3p.	X 4p.	Y	Z2	AA	BA	AC
125 / B3	304	340	244	235	266.5	322.5	151	154	184	120	150	36	20	25	9	26	22	3.5	134	135	115	10
160 / B3	304	340	244	235	266.5	322.5	151	154	184	120	150	36	20	25	9	26	22	3.5	134	135	115	10
250 / B4	345	395	244.5	260	328	378	153	195	245	160	210	50	25	30	11	33	33	3.5	134.5	160	130	15
400 / B4	345	395	244.5	260	328	378	153	195	245	160	210	50	35	35	11	33	33	3.5	134.5	170	140	15
630 / B5	394	459	320.5	400	377	437	221	244	304	210	270	65	45	50	13	42.5	37.5	5	190	260	220	20

SIRCO MOT AT

Remotely operated load break switches
from 125 to 3200 A

Dimensions (continued)

800 to 1600 A

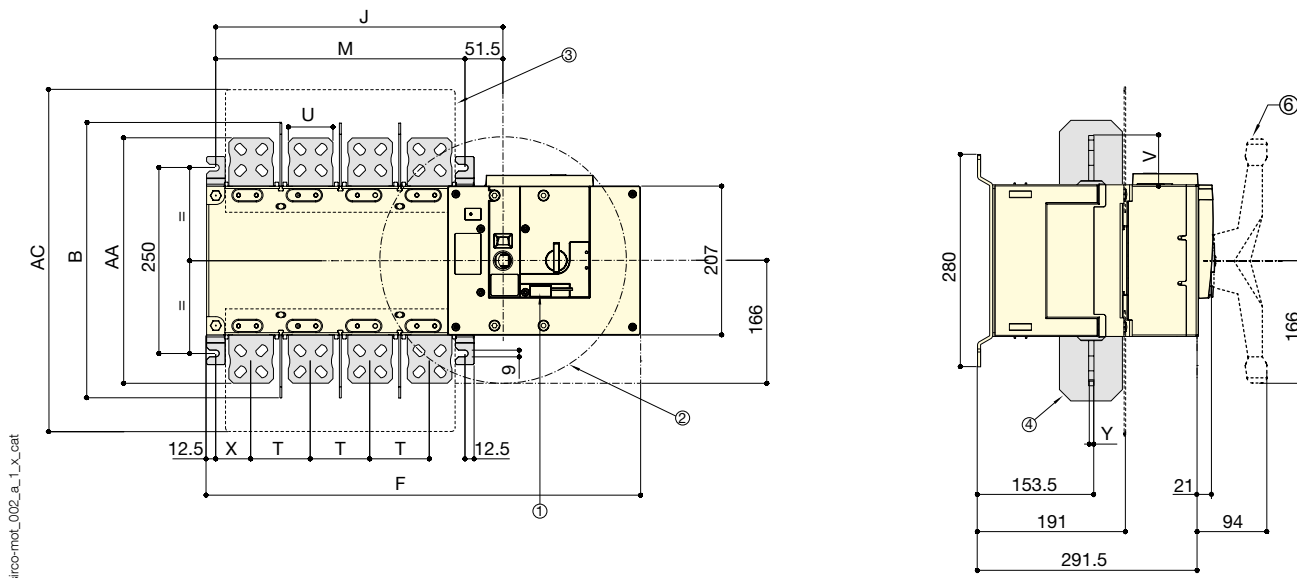

800 to 1000 A

1250 A

1600 A

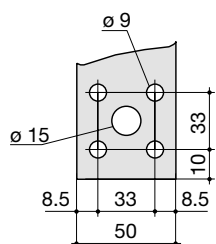

svr_077_a_1_x_cat

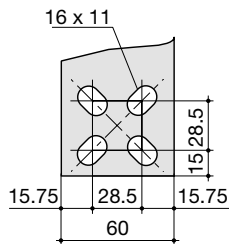

svr_078_b_1_x_cat

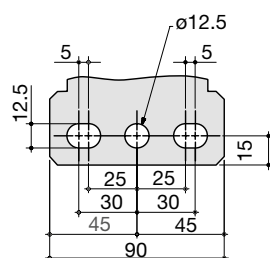

svr_088_a_1_x_cat

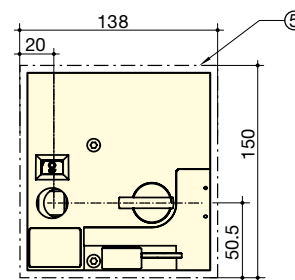

1. Triple padlock tab, 4-8 mm
2. Emergency manual operation: max. handle radius, operating angle 90°
3. Terminal screens
4. Inter-phase screen
5. Cut out dimension
6. Manual emergency operation

Rating (A)	Overall dimensions B	Terminal shrouds AC	Case				Switch mounting		Connection						
			F 3p.	F 4p.	J 3p.	J 4p.	M 3p.	M 4p.	T	U	V	X	Y	Z1	AA
800	370	461	504	584	307	387	255	335	80	50	60.5	47.5	7	66.5	321
1000	370	461	504	584	307	387	255	335	80	50	60.5	47.5	7	66.5	321
1250	370	461	504	584	307	387	255	335	80	60	65	47.5	7	66.5	330
1600	380	531	596	716	399	519	347	467	120	90	44	53	8	67.5	288

2000 to 3200 A

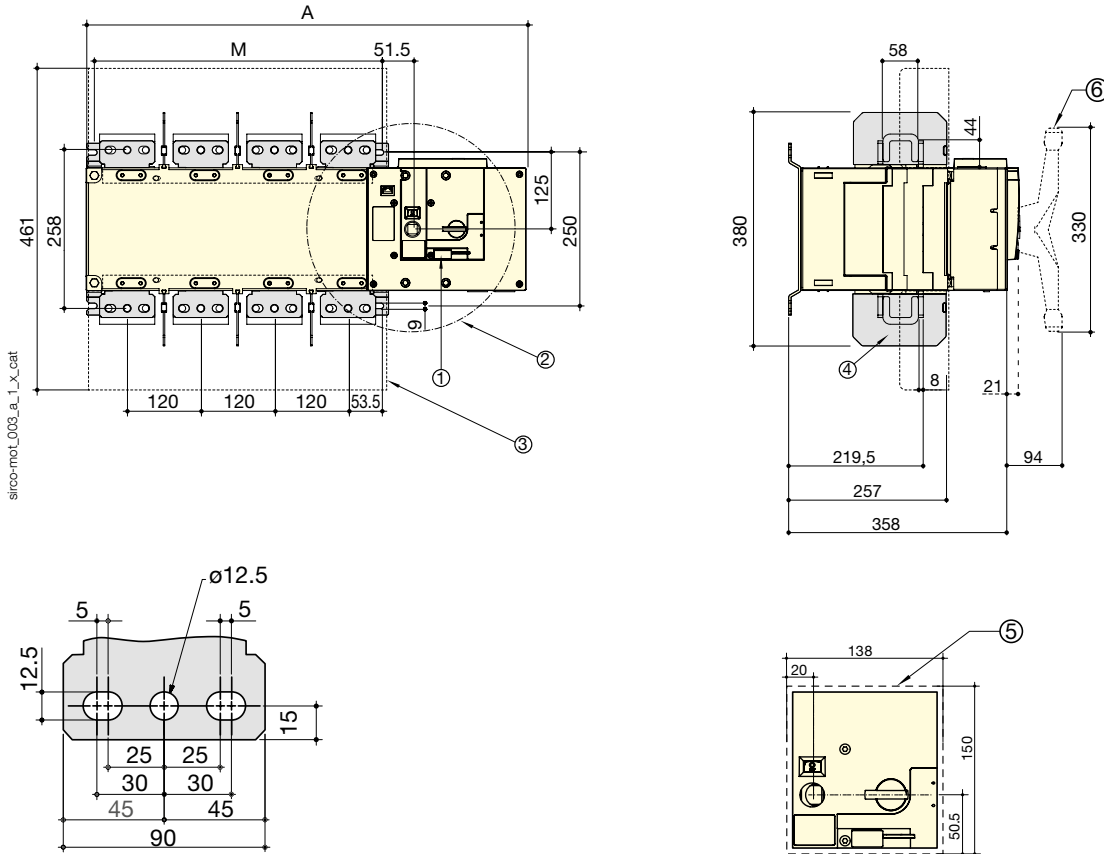

- 1. Triple padlock tab, 4-8 mm
- 2. Emergency manual operation: max. handle radius, operating angle 90°
- 3. Terminal screens
- 4. Inter-phase screen
- 5. Cut out dimension
- 6. Manual emergency operation

Rating (A)	Overall dimensions		Switch mounting	
	A 3p.	A 4p.	M 3p.	M 4p.
2000 ... 3200	596	716	347	467